

MILBANK[®]
ENERGY AT WORK



Recreational Vehicle Park

Electrical Products & Accessories



Milbank Overview

Energy At Work since 1927

Milbank designs and manufactures electrical solutions that move and manage power for the residential, commercial, industrial, utility and transportation sectors. With more than 90 years of expertise in electrical engineering design and manufacturing, Milbank's portfolio includes metering equipment, enclosures and enclosed controls. Founded in 1927, Milbank is a family-owned, American manufacturer headquartered in Kansas City, Mo. For more information, please visit milbankworks.com.

METERING



As a market leader in electrical metering equipment, Milbank has set the standard for quality since 1927. Hundreds of configurations are available, including many sizes, knockout configurations, terminal configurations, bypass options, hubs, locks and connectors. Milbank has the socket you need with thousands of active products to meet your utility's requirements.

ENCLOSURES



Milbank's line of enclosures include commercial junction boxes, panel mount enclosures, transformer cabinets, wireway, and troughs. Built with high-quality craftsmanship and materials which meet or exceed industry standards, Milbank enclosures are made to protect controls and equipment from dust, dirt and other harmful elements found in a wide variety of environments based on various NEMA rating Milbank offers.

ENCLOSED CONTROLS



Milbank doesn't just build empty enclosures. We can deliver the entire package, complete with custom control equipment built to your exact specifications by our engineers. Milbank enclosed controls are an attractive, secure, easy to install and cost-effective solution when underground remote site power distribution and control equipment is required, replacing unsightly and inefficient strut and backboard structures.



Please consult serving utility for their requirements prior to ordering or installing, as specifications and approvals vary by utility, and may require local electrical inspector approval. All installations must be installed by a licensed electrician and must comply with all national and local codes, laws and regulations. Milbank reserves the right to make changes in specifications and features shown without notice or obligation.

Table of Contents

Millennium Series RV Power Outlets

Unmetered Surface Mount Power Outlets.....	4-5
Metered Surface Mount Power Outlets.....	6-7
Unmetered Power Outlet Pedestals	8-9
Metered Power Outlet Pedestals	10-13
Accessories and Replacement Parts.....	14-19

Voyager Series RV Pedestal Power Outlets

Product Specifications and Details	20-21
Accessories and Replacement Parts.....	22-23

Miscellaneous

Dry Type Transformers	24-25
Pad Mount Panel Boards.....	26
Terminal Boxes	27
Energization Information	28
Index.....	29

Please consult serving utility for their requirements prior to ordering or installing, as specifications and approvals vary by utility, and may require local electrical inspector approval. All installations must be installed by a licensed electrician and must comply with all national and local codes, laws and regulations. Milbank reserves the right to make changes in specifications and features shown without notice or obligation.



4

MILLENNIUM
SERIES
SURFACE MOUNT
POWER OUTLETS

Surface Mount Power Outlet

125 Amps | Unmetered | 120/240 VAC



U5000-XL-75

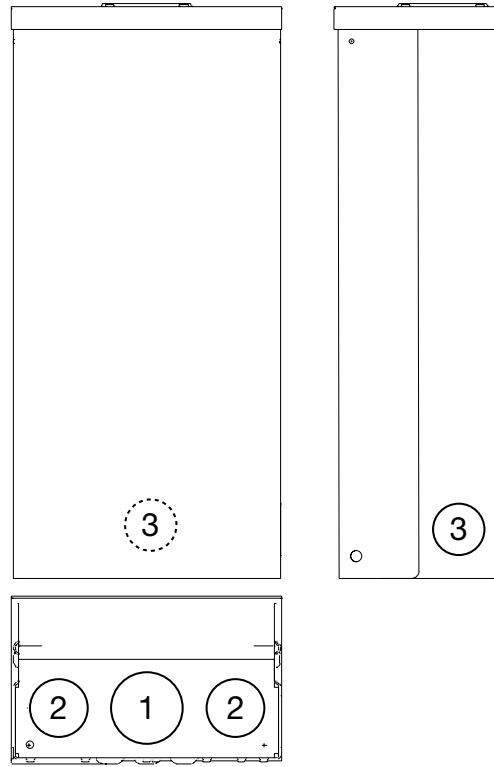

Specifications

- UL listed 125 Amps, 120/240 Volt, 1Ø power outlet.
- Short circuit current withstand rating 10,000 RMS symmetrical amperes.
- Type 3R welded enclosure for durable outdoor use.
- Enclosure constructed with galvanized 16 gauge steel.
- ANSI 61 grey polyester powder coat finish.
- Convenient concentric knock-out configurations and mounting embosses.
- Hub opening with closure plate allows for meter retrofit.
- Wire terminations accept copper or aluminum conductors for loop feed wiring.
Line: (2) 1/0-#12 Ground: (2) 1/0-#14 & (4) #6-#14 Neutral: (2) 1/0-#14 & (4) #6-#14
- Six circuit plated copper interior accepts standard plug-in type circuit breakers. Rated up to 125 Amps.
- Three position self-grounded receptacle bridge accepts most standard NEMA receptacles with mounting plates.
- Components factory wired with stranded copper wire.
- Lockable hinge cover and dead front are removable for installation and maintenance. Stay-open hinge cover has safety interlock on dead front. Dead front cover must be removed before hinge cover can be removed.



Please consult serving utility for their requirements prior to ordering or installing, as specifications and approvals vary by utility, and may require local electrical inspector approval. All installations must be installed by a licensed electrician and must comply with all national and local codes, laws and regulations. Milbank reserves the right to make changes in specifications and features shown without notice or obligation.

Surface Mount Power Outlet





125 Amps | Unmetered | 120/240 VAC

5
MILLENNIUM
SERIES
SURFACE MOUNT
POWER OUTLETS



125 Amps | Surface Mount Power Outlets

Catalog Number	Receptacle Configuration	Circuit Breaker Configuration	Loop Feed	Connectors - Line	Dimensions			Knockouts		
					D"	W"	H"	1	2	3
U5000-XL	—	—	Yes	(2) 1/0-#12	5½	8⅞	19¼	2	1½	1¼
U5000-XL-332	A	W	Yes	(2) 1/0-#12	5½	8⅞	19¼	2	1½	1¼
U5000-XL-41	B	X	Yes	(2) 1/0-#12	5½	8⅞	19¼	2	1½	1¼
U5000-XL-55	C	Y	Yes	(2) 1/0-#12	5½	8⅞	19¼	2	1½	1¼
U5000-XL-75	D	Z	Yes	(2) 1/0-#12	5½	8⅞	19¼	2	1½	1¼

Receptacle Configurations

A	B	C	D
			
(2) TT30R, (1) 5-20R GFI	(1) TT30R, (1) 5-20R GFI	(1) 14-50R, (1) 5-20R GFI	(1) 14-50R, (1) TT30R, (1) 5-20R GFI

Circuit Breaker Configurations

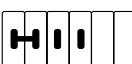
W	X	Y	Z
			
(2) 30A, 1P, 120V (1) 20A, 1P, 120V	(1) 30A, 1P, 120V (1) 20A, 1P, 120V	(1) 50A, 2P, 120/240V (1) 20A, 1P, 120V	(1) 50A, 2P, 120/240V (1) 30A, 1P, 120V (1) 20A, 1P, 120V

Notes

- 20 Amps GFI receptacles are weather resistant and tamper resistant.

Please consult serving utility for their requirements prior to ordering or installing, as specifications and approvals vary by utility, and may require local electrical inspector approval. All installations must be installed by a licensed electrician and must comply with all national and local codes, laws and regulations. Milbank reserves the right to make changes in specifications and features shown without notice or obligation.



Surface Mount Power Outlets

125 Amps | Metered | 120/240 VAC



Loop feed
not available

U5100-XL-75

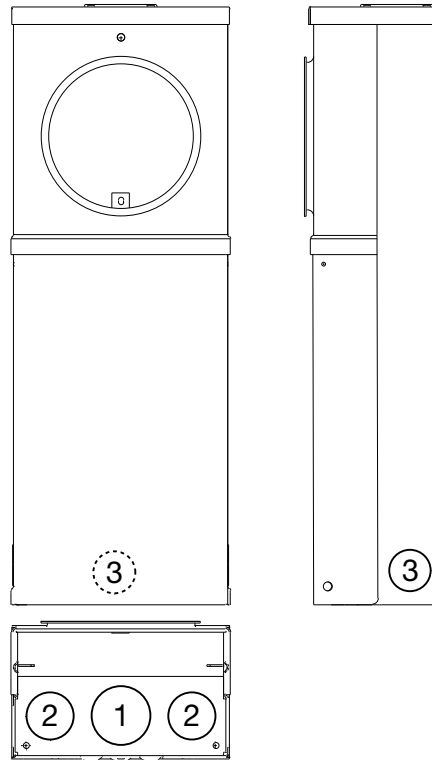

Specifications

- UL listed 125 Amps, 120/240 Volt—1Ø power outlet.
- Short circuit current withstand rating 10,000 RMS symmetrical amperes.
- Type 3R welded enclosure for durable outdoor use.
- Enclosure constructed with galvanized 16 gauge steel.
- ANSI 61 grey polyester powder coat finish.
- Convenient concentric knock-out configurations and mounting embosses.
- Hub opening with closure plate.
- Wire terminations accept copper or aluminum conductors. Loop feed not available.
- Line: (2) #6-250 kcmil Ground: (2) 1/0-#14 & (4) #6-#14 Neutral: (2) 1/0-#14 & (4) #6-#14
- Six circuit plated copper interior accepts standard plug-in type circuit breakers. Rated up to 125 Amps.
- Three position self-grounded receptacle bridge accepts most standard NEMA receptacles with mounting plates.
- Four terminal, ring type meter socket with aluminum sealing ring. Ringless type meter socket available. Use **U5101** prefix.
- Components factory wired with stranded copper wire.
- Lockable hinge cover and dead front are removable for installation and maintenance. Stay-open hinge cover has safety interlock on dead front. Dead front must be removed before hinge cover can be removed.
- LED or fluorescent site light kits available. Factory or field installable. See accessories page.
- Unit weight: 26 lbs.



Please consult serving utility for their requirements prior to ordering or installing, as specifications and approvals vary by utility, and may require local electrical inspector approval. All installations must be installed by a licensed electrician and must comply with all national and local codes, laws and regulations. Milbank reserves the right to make changes in specifications and features shown without notice or obligation.

Surface Mount Power Outlets

125 Amps | Metered | 120/240 VAC

125 Amps | Surface Mount Power Outlets

Catalog Number	Meter Type	Receptacle Configuration	Circuit Breaker Configuration	Loop Feed	Connectors - Line	Dimensions			Knockouts		
						D"	W"	H"	1	2	3
U5100-XL	Ring Type	—	—	No	#6-250	5½	8⅞	25	2	1½	1¼
U5101-XL	Ringless	—	—	No	#6-250	5½	8⅞	25	2	1½	1¼
U5100-XL-41	Ring Type	A	X	No	#6-250	5½	8⅞	25	2	1½	1¼
U5100-XL-55	Ring Type	B	Y	No	#6-250	5½	8⅞	25	2	1½	1¼
U5100-XL-75	Ring Type	C	Z	No	#6-250	5½	8⅞	25	2	1½	1¼

Receptacle Configurations

A	B	C
(1) TT30R, (1) 5-20R GFI	(1) 14-50R, (1) 5-20R GFI	(1) 14-50R, (1) TT30R, (1) 5-20R GFI

Circuit Breaker Configurations

X	Y	Z
(1) 30A, 1P, 120V (1) 20A, 1P, 120V	(1) 50A, 2P, 120/240V (1) 20A, 1P, 120V	(1) 50A, 2P, 120/240V (1) 30A, 1P, 120V (1) 20A, 1P, 120V

Notes

- 20 Amps GFI receptacles are weather resistant and tamper resistant.
- 20 Amps GFI required at each RV site by UL and NEC 551-71.
- LED or fluorescent site light kits available. Factory or field installable. See accessories page.
- Contact factory for additional configurations not shown here.

Please consult serving utility for their requirements prior to ordering or installing, as specifications and approvals vary by utility, and may require local electrical inspector approval. All installations must be installed by a licensed electrician and must comply with all national and local codes, laws and regulations. Milbank reserves the right to make changes in specifications and features shown without notice or obligation.



Power Outlet Pedestals

125 Amps | Unmetered | 120/240 VAC



U5200-XL-75

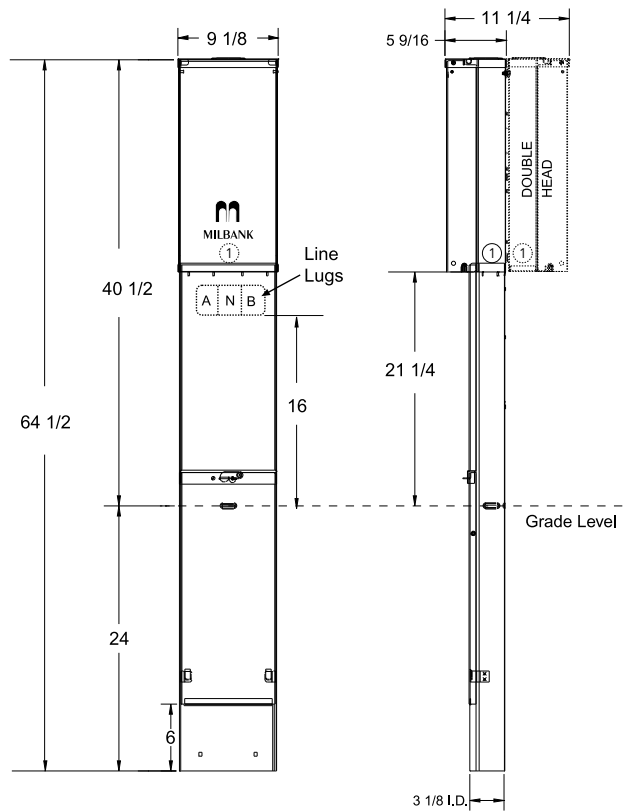

Specifications

- UL listed 125 Amps, 120/240 Volt—1Ø power outlet.
- Short circuit current withstand rating 10,000 RMS symmetrical amperes.
- Type 3R welded enclosure for durable outdoor use.
- Enclosure constructed with galvanized 16 gauge steel.
- Direct burial or pad mounted post constructed with 16 gauge galvanized steel. Two removable front covers for ease of installation. Accepts up to (3) 2 1/2" conduits.
- ANSI 61 grey polyester powder coat finish.
- Convenient concentric knock-out configurations.
- Hub opening with closure plate allows for meter retrofit.
- Wire terminations accept copper or aluminum conductors for loop feed wiring.
- Line: (2) #6-350 kcmil per phase, ground: (2) #14-2/0, neutral: (2) #6-350 kcmil
- Six circuit plated copper interior accepts standard plug-in type circuit breakers. Rated up to 125 Amps.
- Three position self-grounded receptacle bridge accepts most standard NEMA receptacles with mounting plates.
- Components factory wired with stranded copper wire.
- Lockable hinge cover and dead front are removable for installation and maintenance. Stay-open hinge cover has safety interlock on dead front. Deadfront must be removed before hinge cover can be removed.
- LED or fluorescent site light kits available. Factory or field installable. See accessories page.
- Unit weight - single: 48 lbs., double: 70 lbs.



Please consult serving utility for their requirements prior to ordering or installing, as specifications and approvals vary by utility, and may require local electrical inspector approval. All installations must be installed by a licensed electrician and must comply with all national and local codes, laws and regulations. Milbank reserves the right to make changes in specifications and features shown without notice or obligation.

Power Outlet Pedestals

125 Amps | Unmetered | 120/240 VAC

125 Amps | Unmetered Power Outlet Pedestals

Catalog Number	Mounting Type	Powerheads	Receptacle Configuration	Circuit Breaker Configuration	Loop Feed	Connectors (Line)	Dimensions			Knockouts
							D"	W"	H"	
U5200-XL	Direct Burial	Single	—	—	Yes	#6-350	5 ⁷ / ₁₆	8 ¹¹ / ₁₆	64 ¹ / ₂	1 ¹ / ₄
U5200-XL-332	Direct Burial	Single	A	W	Yes	#6-350	5 ⁷ / ₁₆	8 ¹¹ / ₁₆	64 ¹ / ₂	1 ¹ / ₄
U5200-XL-41	Direct Burial	Single	B	X	Yes	#6-350	5 ⁷ / ₁₆	8 ¹¹ / ₁₆	64 ¹ / ₂	1 ¹ / ₄
U5200-XL-55	Direct Burial	Single	C	Y	Yes	#6-350	5 ⁷ / ₁₆	8 ¹¹ / ₁₆	64 ¹ / ₂	1 ¹ / ₄
U5200-XL-75	Direct Burial	Single	D	Z	Yes	#6-350	5 ⁷ / ₁₆	8 ¹¹ / ₁₆	64 ¹ / ₂	1 ¹ / ₄
U5210-XL	Pad Mount	Single	—	—	Yes	#6-350	5 ⁷ / ₁₆	8 ¹¹ / ₁₆	40 ¹ / ₂	1 ¹ / ₄
U5220-XL	Direct Burial	Double	—	—	Yes	#6-350	11 ¹ / ₄	8 ¹¹ / ₁₆	64 ¹ / ₂	1 ¹ / ₄
U5220-XL-41	Direct Burial	Double	B	X	Yes	#6-350	11 ¹ / ₄	8 ¹¹ / ₁₆	64 ¹ / ₂	1 ¹ / ₄
U5220-XL-75	Direct Burial	Double	D	Z	Yes	#6-350	11 ¹ / ₄	8 ¹¹ / ₁₆	64 ¹ / ₂	1 ¹ / ₄
U5230-XL	Pad Mount	Double	—	—	Yes	#6-350	11 ¹ / ₄	8 ¹¹ / ₁₆	40 ¹ / ₂	1 ¹ / ₄

Receptacle Configurations

A	B	C	D
(2) TT30R, (1) 5-20R GFI	(1) TT30R, (1) 5-20R GFI	(1) 14-50R, (1) 5-20R GFI	(1) 14-50R, (1) TT30R, (1) 5-20R GFI

Circuit Breaker Configurations

W	X	Y	Z
(2) 30A, 1P, 120V (1) 20A, 1P, 120V	(1) 30A, 1P, 120V (1) 20A, 1P, 120V	(1) 50A, 2P, 120/240V (1) 20A, 1P, 120V	(1) 50A, 2P, 120/240V (1) 30A, 1P, 120V (1) 20A, 1P, 120V

Notes

- 20 Amps GFI receptacles are weather resistant and tamper resistant.
- 20 Amps GFI required at each RV site by UL and NEC 551-71.
- LED or fluorescent site light kits available. Factory or field installable. See accessories page.
- Contact factory for additional configurations not shown here.

Please consult serving utility for their requirements prior to ordering or installing, as specifications and approvals vary by utility, and may require local electrical inspector approval. All installations must be installed by a licensed electrician and must comply with all national and local codes, laws and regulations. Milbank reserves the right to make changes in specifications and features shown without notice or obligation.



Power Outlet Pedestals

125 Amps | Metered | 120/240 VAC



U5300-O-75

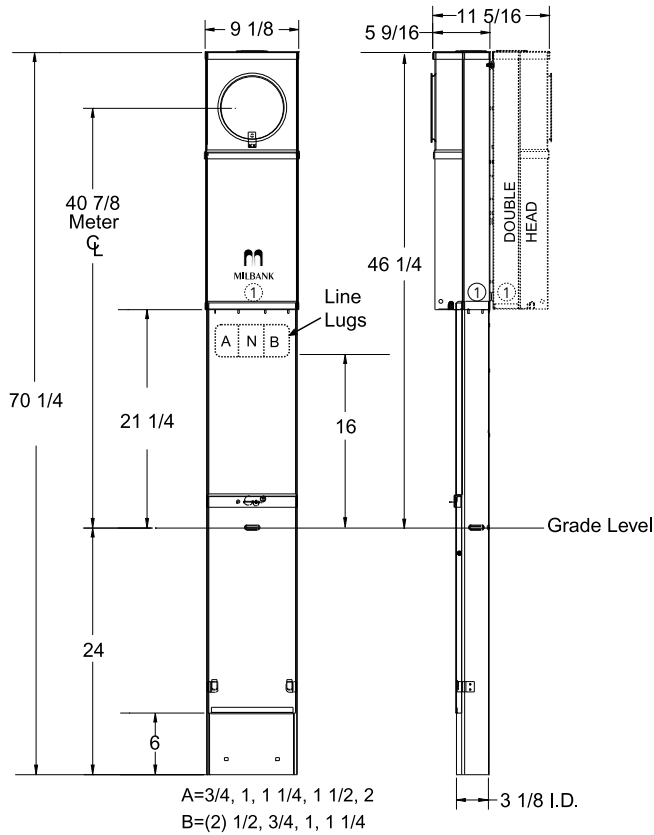

Specifications

- UL listed 125 Amps, 120/240 volts—1Ø power outlet.
- Short circuit current withstand rating 10,000 RMS symmetrical amperes.
- Type 3R welded enclosure for durable outdoor use.
- Enclosure constructed with galvanized 16 gauge steel.
- Direct burial or pad mounted post constructed with 16 gauge galvanized steel. Two removable front covers for ease of installation. Accepts up to (3) 2 1/2" conduits.
- ANSI 61 grey polyester powder coat finish.
- Wire terminations accept copper or aluminum conductors for loop feed wiring. Line: (2) #6-350 kcmil per phase
Ground: (2) #14-2/0 Neutral: (2) #6-350 kcmil
- Six circuit plated copper interior accepts standard plug-in type circuit breakers. Rated up to 125 Amps.
- Three position self-grounded receptacle bridge accepts most standard NEMA receptacles with mounting plates.
- Four terminal, drawn ring type meter socket with aluminum sealing ring.
- Components factory wired with stranded copper wire.
- Lockable hinge cover and dead front are removable for installation and maintenance. Stay-open hinge cover has safety interlock on dead front. Dead front must be removed before hinge cover can be removed.
- LED or fluorescent site light kits available. Factory or field installable. See accessories page.
- Unit weight - single: 53 lbs., double: 80 lbs.



Please consult serving utility for their requirements prior to ordering or installing, as specifications and approvals vary by utility, and may require local electrical inspector approval. All installations must be installed by a licensed electrician and must comply with all national and local codes, laws and regulations. Milbank reserves the right to make changes in specifications and features shown without notice or obligation.

Power Outlet Pedestals

125 Amps | Metered | 120/240 VAC

125 Amps | Metered Power Outlet Pedestals

Catalog Number	Mounting Type	Powerheads	Receptacle Configuration	Circuit Breaker Configuration	Loop Feed	Connectors (Line)	Dimensions			Knockouts
							D"	W"	H"	
U5300-O	Direct Burial	Single	—	—	Yes	#6-350	5 ⁵ / ₁₆	8 ¹¹ / ₁₆	70 ¹ / ₄	1 ¹ / ₄
U5300-O-41	Direct Burial	Single	A	X	Yes	#6-350	5 ⁵ / ₁₆	8 ¹¹ / ₁₆	70 ¹ / ₄	1 ¹ / ₄
U5300-O-55	Direct Burial	Single	B	Y	Yes	#6-350	5 ⁵ / ₁₆	8 ¹¹ / ₁₆	70 ¹ / ₄	1 ¹ / ₄
U5300-O-75	Direct Burial	Single	C	Z	Yes	#6-350	5 ⁵ / ₁₆	8 ¹¹ / ₁₆	70 ¹ / ₄	1 ¹ / ₄
U5310-O	Pad Mount	Single	—	—	Yes	#6-350	5 ⁵ / ₁₆	8 ¹¹ / ₁₆	46 ¹ / ₄	1 ¹ / ₄
U5320-O	Direct Burial	Double	—	—	Yes	#6-350	11 ³ / ₁₆	8 ¹¹ / ₁₆	70 ¹ / ₄	1 ¹ / ₄
U5320-O-75	Direct Burial	Double	C	Z	Yes	#6-350	11 ³ / ₁₆	8 ¹¹ / ₁₆	70 ¹ / ₄	1 ¹ / ₄
U5330-O	Pad Mount	Double	—	—	Yes	#6-350	11 ³ / ₁₆	8 ¹¹ / ₁₆	46 ¹ / ₄	1 ¹ / ₄

Receptacle Configurations

A	B	C
(1) TT30R, (1) 5-20R GFI	(1) 14-50R, (1) 5-20R GFI	(1) 14-50R, (1) TT30R, (1) 5-20R GFI

Circuit Breaker Configurations

X	Y	Z
(1) 30A, 1P, 120V (1) 20A, 1P, 120V	(1) 50A, 2P, 120/240V (1) 20A, 1P, 120V	(1) 50A, 2P, 120/240V (1) 30A, 1P, 120V (1) 20A, 1P, 120V

Notes

- 20 Amps GFI receptacles are weather resistant and tamper resistant.
- 20 Amps GFI required at each RV site by UL and NEC 551-71.
- LED or fluorescent site light kits available. Factory or field installable. See accessories page.
- Contact factory for additional configurations not shown here.

Please consult serving utility for their requirements prior to ordering or installing, as specifications and approvals vary by utility, and may require local electrical inspector approval. All installations must be installed by a licensed electrician and must comply with all national and local codes, laws and regulations. Milbank reserves the right to make changes in specifications and features shown without notice or obligation.



Millennium Series

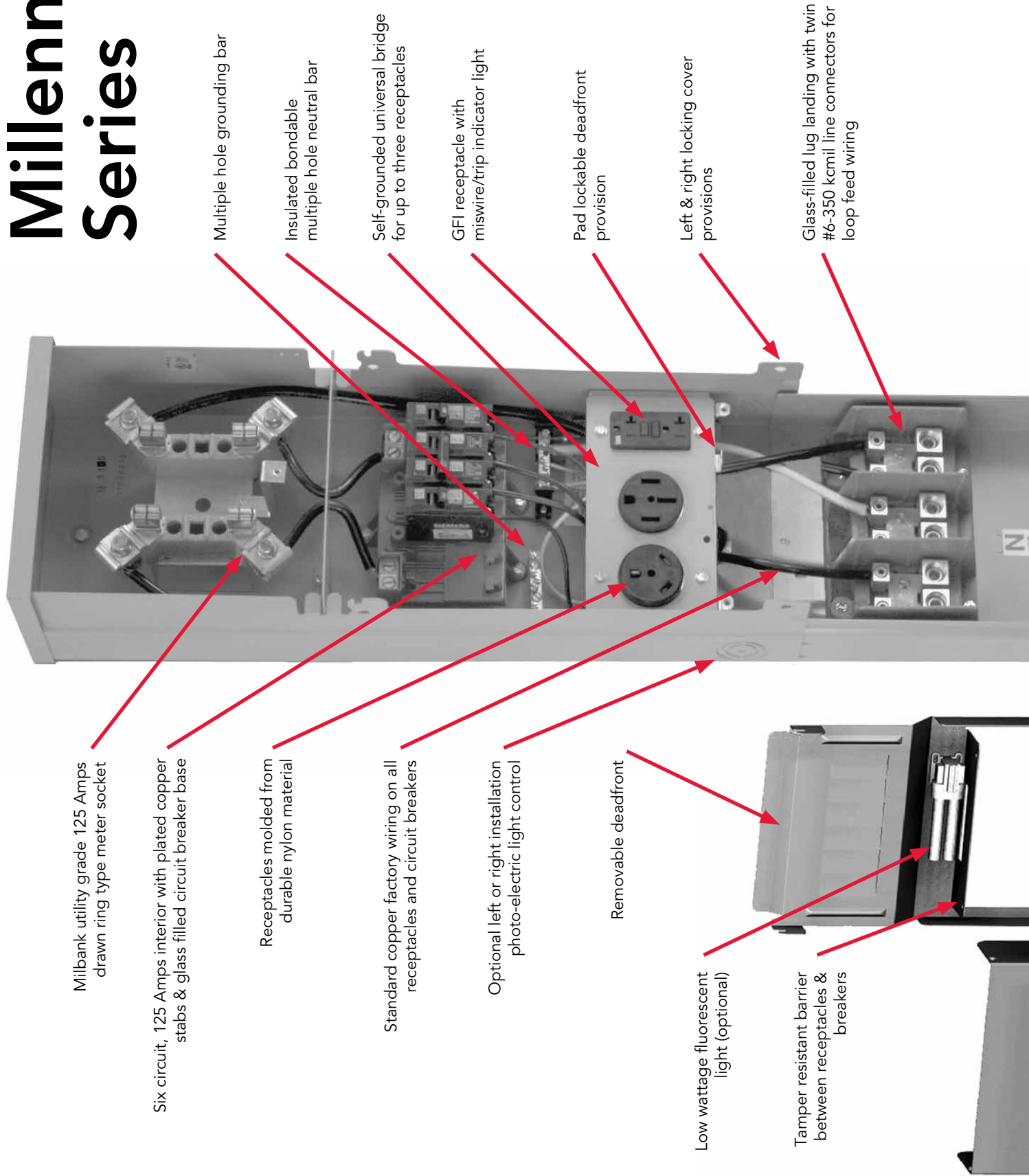

Milbank utility grade 125 Amps drawn ring type meter socket

Six circuit, 125 Amps interior with plated copper stabs & glass filled circuit breaker base

Receptacles molded from durable nylon material

Standard copper factory wiring on all receptacles and circuit breakers

Optional left or right installation photo-electric light control

Removable deadfront

Low wattage fluorescent light (optional)

Tamper resistant barrier between receptacles & breakers

Multiple hole grounding bar

Insulated bondable multiple hole neutral bar

Self-grounded universal bridge for up to three receptacles

GFI receptacle with miswire/trip indicator light

Pad lockable deadfront provision

Left & right locking cover provisions

Glass-filled lug landing with twin #6-350 kcmil line connectors for loop feed wiring

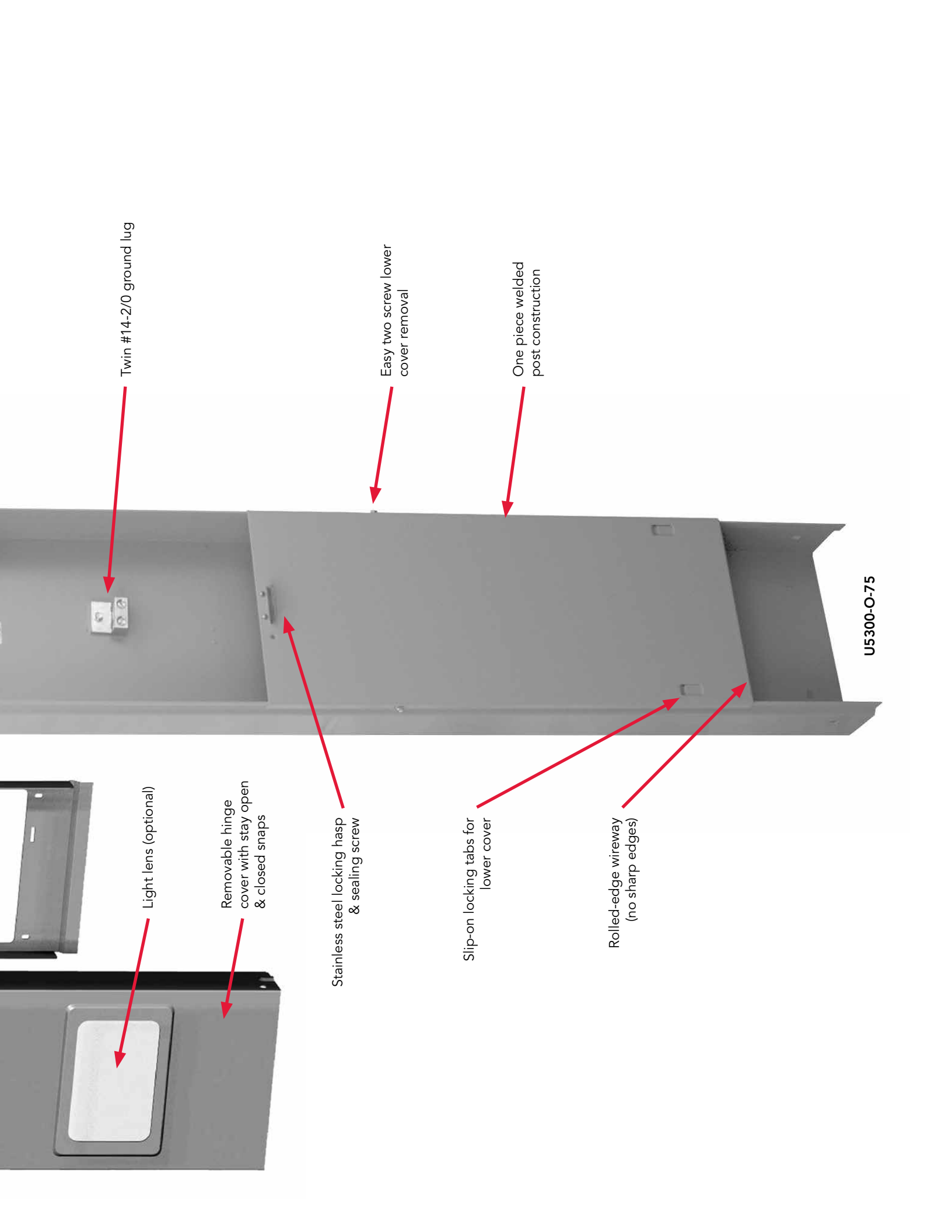

U5300-O-75

Twin #14-2/0 ground lug

Easy two screw lower cover removal

One piece welded post construction

Light lens (optional)

Removable hinge cover with stay open & closed snaps

Stainless steel locking hasp & sealing screw

Slip-on locking tabs for lower cover

Rolled-edge wireway (no sharp edges)

Replacement Receptacle Plates

For Millennium Series RV Products

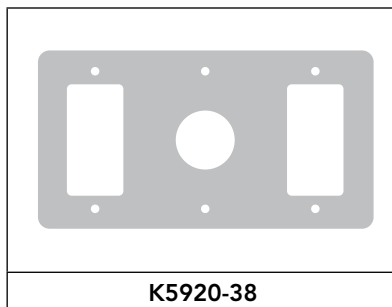
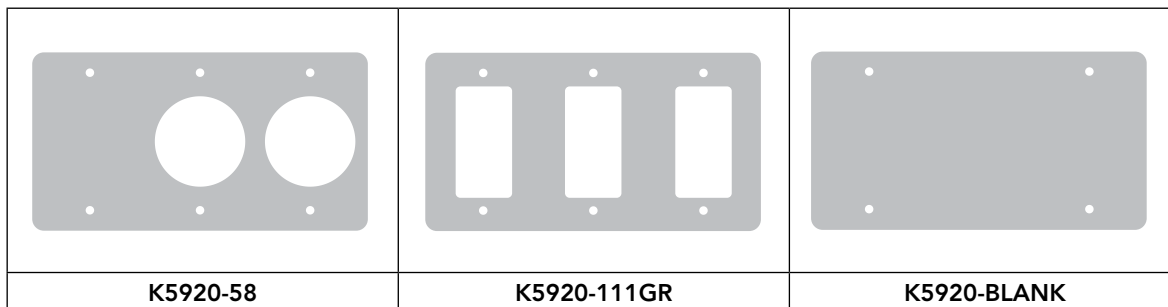
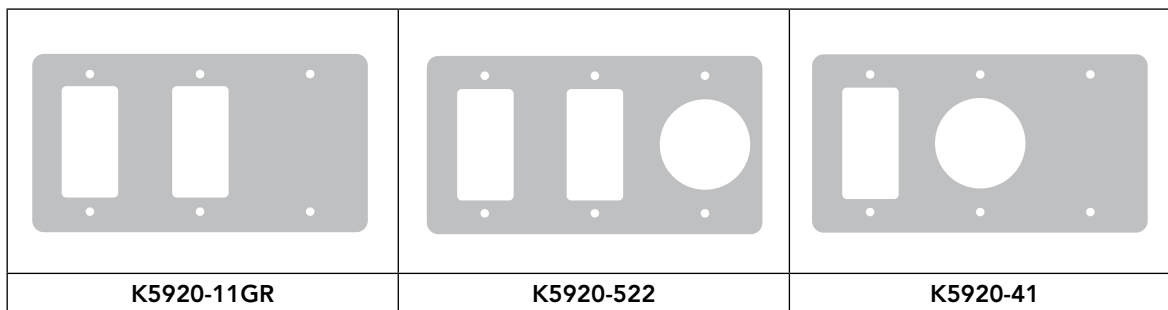
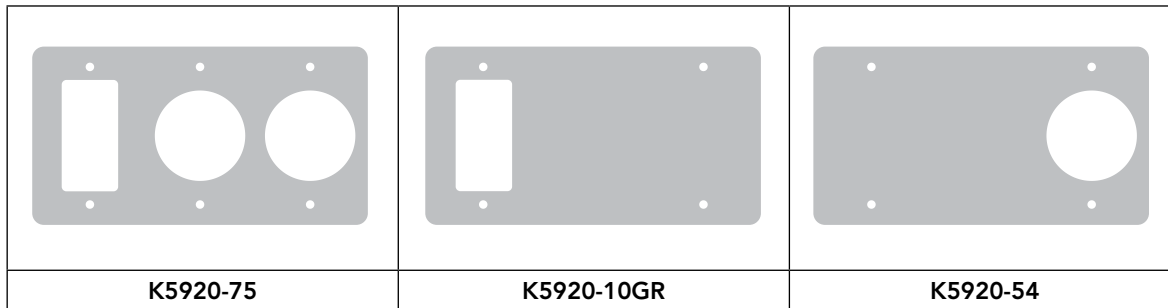

Notes

- For application details, consult factory.



Please consult serving utility for their requirements prior to ordering or installing, as specifications and approvals vary by utility, and may require local electrical inspector approval. All installations must be installed by a licensed electrician and must comply with all national and local codes, laws and regulations. Milbank reserves the right to make changes in specifications and features shown without notice or obligation.

Lighting Accessories

For Millennium Series RV Products

Internal Light Kits for Unmetered Power Outlets (U5000 & U5200)

Application	Internal light kit for unmetered power outlets	
Features	Includes 5-watt fluorescent or LED lamps, socket, lamp shield and opaque hinge cover lens. Factory wired to 20 Amps GFI circuit. May be wired to separate 20 Amps circuit breaker. Order Q120 separately. Cover on unmetered power outlet is 19 $\frac{1}{8}$ " in height.	
Ordering	Order with -L suffix (after catalog number) for factory installed fluorescent and -LD for factory installed LED. Order catalog number K5411 for field installed 5-watt fluorescent lamps. Order catalog number K6212 for field installed LED lamps.	

Internal Light Kits for Metered Power Outlets (U5100 & U5300)

Application	Internal light kit for metered power outlets	
Features	Includes 5-watt fluorescent or LED lamps, socket, lamp shield and opaque hinge cover lens. Factory wired to 20 Amps GFI circuit. May be wired to separate 20 Amps circuit breaker. Order Q120 separately. Cover on unmetered power outlet is 15 $\frac{1}{4}$ " in height.	
Ordering	Order with -L suffix (after catalog number) for factory installed fluorescent and -LD for factory installed LED. Order catalog number K5412 for field installed 5-watt fluorescent lamps. Order catalog number K6213 for field installed LED lamps.	

Photoelectric Light Control Kit

Application	Photoelectric light control kit for K5411, K5412, K6212, K6213 light kits.	
Features	2.5 Amps, 120 volt photo electrical control wired in series with K5411, K5412, K6212, K6213 light kits.	
Ordering	Order with -LPC suffix for factory installed fluorescent light and PE control. Order with -LDP suffix for factor installed LED light and PE control Order catalog number K5413 for field installed.	

WARNING!

Always disconnect power prior to installing these devices.

Please consult serving utility for their requirements prior to ordering or installing, as specifications and approvals vary by utility, and may require local electrical inspector approval. All installations must be installed by a licensed electrician and must comply with all national and local codes, laws and regulations. Milbank reserves the right to make changes in specifications and features shown without notice or obligation.



Telephone and Cable TV Kit

Application	Mounts to rear of pedestal series U5200 and U5300 . May also be adaptable to a wooden or similar structure.	
Features	<p>Single: 16" galvanized raceway, (1) RJ11 telephone jack and (1) Type F coaxial CATV jack. (K4709-02)</p> <p>Dual: 16" galvanized raceway, (2) RJ11 telephone jacks and (1) Type F coaxial CATV jack. (K4709-03)</p> <p>Includes mounting hardware and instructions.</p>	
Ordering	Single line telephone and cable TV kit order K4709-02 .	
Note	Confirm acceptability with Cable TV and Telephone provider before ordering or installing these devices.	

Water Shroud with Hardware

Application	Used to cover water pipe and provide means to mount hose bib to rear of pedestal.	
Features	<p>Includes mounting hardware and instructions.</p> <p>Matches K4709 kits when mounted side-by-side.</p>	
Ordering	Order catalog number K4709-WS .	

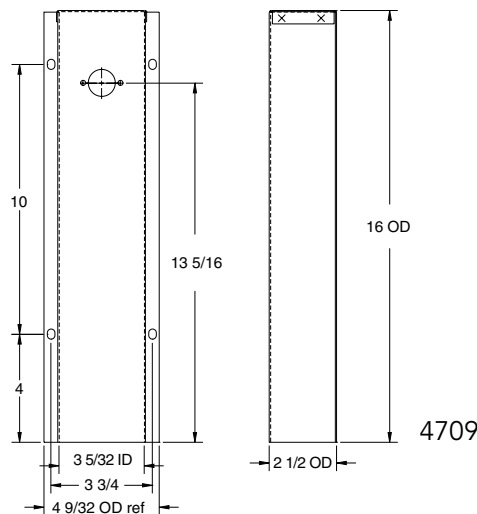

Please consult serving utility for their requirements prior to ordering or installing, as specifications and approvals vary by utility, and may require local electrical inspector approval. All installations must be installed by a licensed electrician and must comply with all national and local codes, laws and regulations. Milbank reserves the right to make changes in specifications and features shown without notice or obligation.

Pedestal Mounting Accessories

For Millennium Series RV Products

Field-Installed Pad Mount Kit

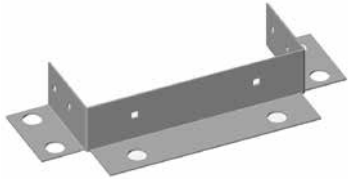
Application	Field installed pad mount kit with (6) 3/4" mounting holes.	
Features	Includes 1/4-20 stainless steel hardware to attach pad mount base to post. Anchor bolt kit sold separately (order catalog number K5421).	
Ordering	Order catalog number K5410 .	

Stabilizer Foot with Hardware

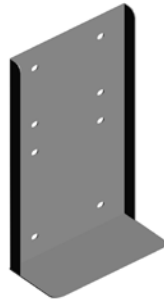
Application	Stabilizes direct burial type posts in unstable soil conditions.	
Features	Includes 1/4-20 hardware to attach to U5200 and U5300 pedestals.	
Ordering	Order catalog number K5415 .	

Anchor Bolt Kit

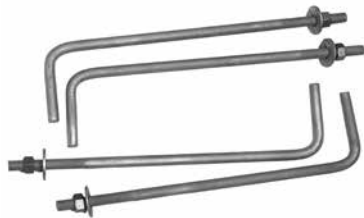
Application	Concrete anchor bolt kit designed to attach pad mount base to concrete.	
Features	(4) sets of zinc-plated 5/8-11 x 10" bolt with 2" toe. Includes nut and flat washer.	
Ordering	Order catalog number K5421 .	

Please consult serving utility for their requirements prior to ordering or installing, as specifications and approvals vary by utility, and may require local electrical inspector approval. All installations must be installed by a licensed electrician and must comply with all national and local codes, laws and regulations. Milbank reserves the right to make changes in specifications and features shown without notice or obligation.





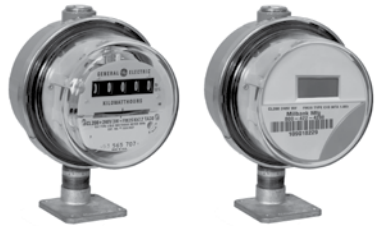

Field-Installed Meter Kits

Application	Field installed meter kit for U5000 and U5200 power outlets.	 <p><i>K4800-01 subject to availability</i></p>
Features	<ul style="list-style-type: none"> • 100 Amps cast meter socket, CL200 E-Z Read Meter, sealing ring, security seal, 1" Milbank hub, nipple and mounting screws. • See CL200 for Watt-hour meter specification. 	
Ordering	Order catalog number K4800-01 for analog meters, and K4800-D for digital meters.	

E-Z Read Watt-Hour Meters

Application	200 Amps E-Z read watt-hour meter designed to be field installed on the U5100 and U5300 metered power outlets.	 <p><i>CL200 subject to availability</i></p>
Features	<ul style="list-style-type: none"> • 200 Amps form 2S 120/240 volt. • Numeric readout in full kilowatt increments. No "tenths" dial. • Remanufactured to 1% accuracy. 	
Ordering	Order catalog number CL200 for analog meters, and CL200-D for digital meters.	

Single Receptacle Only Power Outlet

Application	Overhead/underground power outlet receptacle, suitable for RV, temporary service, and campground equipment.			
Features	<ul style="list-style-type: none"> • Type 3R, 120/240 volt single phase. • Lockable cover. • Breaker not included (in receptacle box). 			
Ordering	Order catalog number from chart below.			
Receptacle Options	 P-10GWR 20A 5-20GR 120V GFI	 P-13 30A TT-30R 120V	 P-54 50A 14-50R 120/240V	

WARNING!

Always disconnect power prior to installing these devices.





Please consult serving utility for their requirements prior to ordering or installing, as specifications and approvals vary by utility, and may require local electrical inspector approval. All installations must be installed by a licensed electrician and must comply with all national and local codes, laws and regulations. Milbank reserves the right to make changes in specifications and features shown without notice or obligation.





Replacement Parts & Accessories

For Millennium Series RV Products

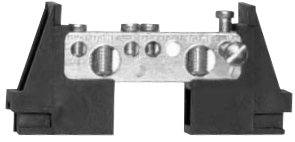

19

REPLACEMENT
PARTS &
ACCESSORIES

			
Z918449-AC (19" unmetered) Z918447-AC (15" metered) Hinge cover	Z818052-SC (19" unmetered) Z818480-SC (15" metered) Deadfront	MR-2 Snap action sealing ring	Neutral assembly shown with 2 insulator supports (Z706230-MO), a ground connector (Z705790-AC) and bonding screw (Z707365-SC)

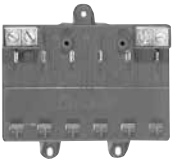
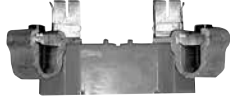
			
Q120 20 Amps, 1 pole circuit breaker	708784-MO 20 Amps, 1 pole GFI circuit breaker	Q130 30 Amps, 1 pole circuit breaker	Q250 50 Amps, 2 pole circuit breaker

		
Z918466-AC Lug landing base	Z917602-AC Circuit breaker base (6-circuit)	Z915141-AC Left or right meter block assembly

		
Z708080-MO 20 Amps GFI receptacle NEMA 5-20GR	Z701776-MO 30 Amps receptacle NEMA TT-30	Z708767-MO 50 Amps receptacle NEMA 14-50R

Please consult serving utility for their requirements prior to ordering or installing, as specifications and approvals vary by utility, and may require local electrical inspector approval. All installations must be installed by a licensed electrician and must comply with all national and local codes, laws and regulations. Milbank reserves the right to make changes in specifications and features shown without notice or obligation.



Voyager Series Pedestal Power Outlet

100 Amps | 120/240 VAC

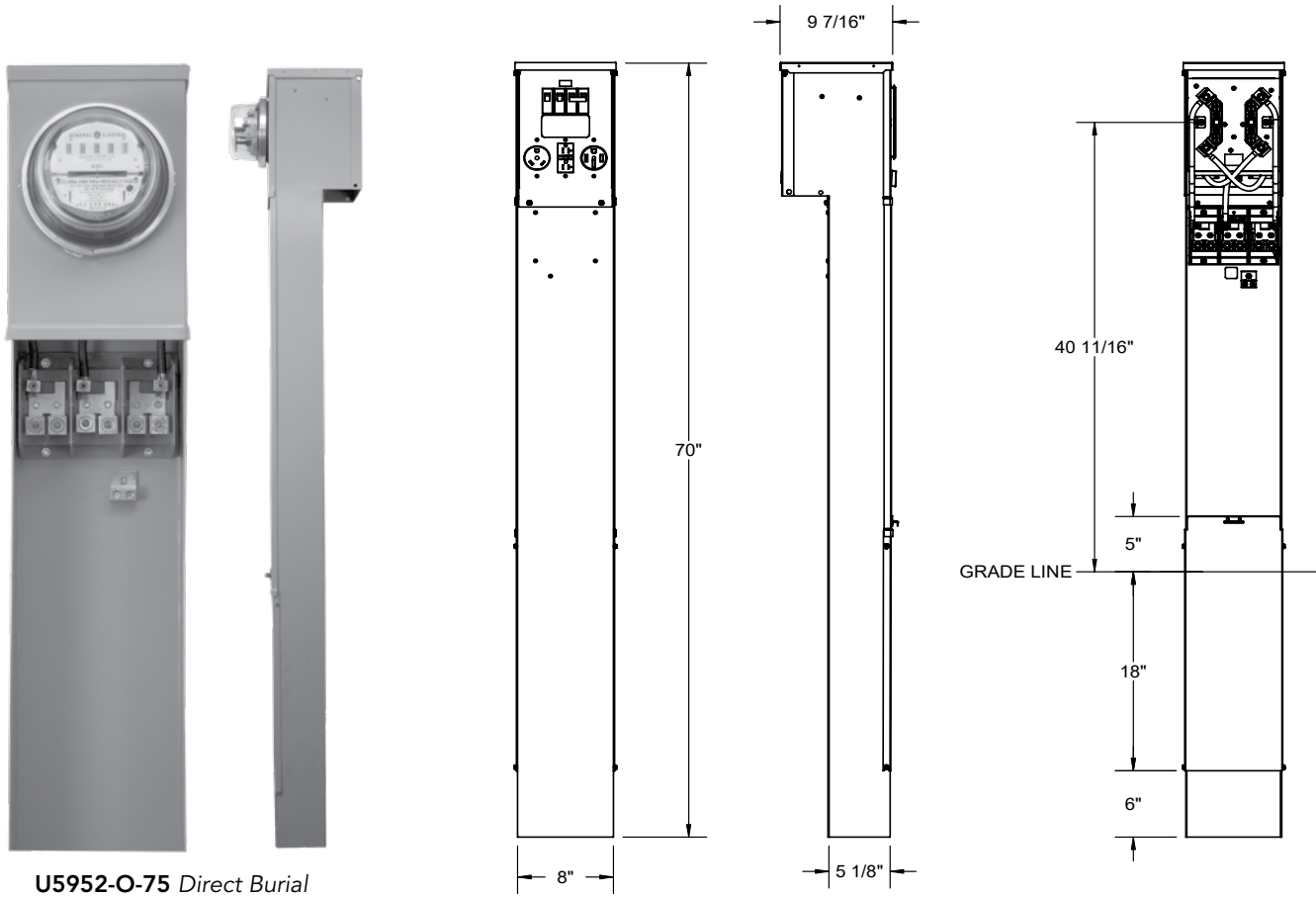

U5952-O-75 Direct Burial

Specifications

- UL listed 100 Amps, 120/240 volts—1Ø power outlet.
- Ring-type version only.
- Metered and unmetered versions available.
- Short circuit current withstand rating 10,000 RMS symmetrical amperes.
- Type 3R welded enclosure for durable outdoor use.
- Direct burial or pad mounted post constructed with 14 gauge galvanized steel. Removable covers for ease of installation.
- ANSI 61 grey polyester powder coat finish.
- Wire terminations accept copper or aluminum conductors for loop feed wiring.
 Line: (4) #6-350 kcmil Ground: (2) #14-2/0 Neutral: (2) #6-350 kcmil
- Four circuit plated copper interior accepts standard plug-in type circuit breakers. Rated up to 100 Amps.
- Components factory wired with stranded aluminum wire.
- Lockable hinge cover and dead front are removable for installation and maintenance.
- Unit weights: direct burial, metered (55 lbs.); direct burial, unmetered (37 lbs.); pad mount, metered (44 lbs.); pad mount, unmetered (26 lbs.).



Please consult serving utility for their requirements prior to ordering or installing, as specifications and approvals vary by utility, and may require local electrical inspector approval. All installations must be installed by a licensed electrician and must comply with all national and local codes, laws and regulations. Milbank reserves the right to make changes in specifications and features shown without notice or obligation.

Voyager Series Pedestal Power Outlet

100 Amps | 120/240 VAC

21
VOYAGER
SERIES
PEDESTAL
POWER OUTLETS

100 Amps | Voyager Series Pedestal Power Outlets

Catalog Number	Metered/ Unmetered	Mounting Method	Receptacle Config.	Circuit Breaker Config.	Loop Feed	Connectors (Line)	Dimensions		
							D"	W"	H"
U5950-O-41	Unmetered	Direct Burial	A	W	Yes	#6-350	3¼	8	60
U5950-O-55	Unmetered	Direct Burial	B	X	Yes	#6-350	3¼	8	60
U5950-O-332	Unmetered	Direct Burial	C	Y	Yes	#6-350	3¼	8	60
U5950-O-75	Unmetered	Direct Burial	D	Z	Yes	#6-350	3¼	8	60
U5951-O-41	Unmetered	Pad Mount	A	W	Yes	#6-350	3¼	8	36
U5951-O-55	Unmetered	Pad Mount	B	X	Yes	#6-350	3¼	8	36
U5951-O-332	Unmetered	Pad Mount	C	Y	Yes	#6-350	3¼	8	36
U5951-O-75	Unmetered	Pad Mount	D	Z	Yes	#6-350	3¼	8	36
U5952-O-41	Metered	Direct Burial	A	W	Yes	#6-350	5⅞	8	70
U5952-O-55	Metered	Direct Burial	B	X	Yes	#6-350	5⅞	8	70
U5952-O-332	Metered	Direct Burial	C	Y	Yes	#6-350	5⅞	8	70
U5952-O-75	Metered	Direct Burial	D	Z	Yes	#6-350	5⅞	8	70
U5953-O-41	Metered	Pad Mount	A	W	Yes	#6-350	5⅞	8	46
U5953-O-55	Metered	Pad Mount	B	X	Yes	#6-350	5⅞	8	46
U5953-O-332	Metered	Pad Mount	C	Y	Yes	#6-350	5⅞	8	46
U5953-O-75	Metered	Pad Mount	D	Z	Yes	#6-350	5⅞	8	46

Receptacle Configurations

A	B	C	D
(1) TT30R, (1) 5-20R GFI	(1) 14-50R, (1) 5-20R GFI	(2) TT30R, (1) 5-20R GFI	(1) 14-50R, (1) TT30R, (1) 5-20R GFI

Circuit Breaker Configurations

W	X	Y	Z
(1) 30A, 1P, 120V (1) 20A, 1P, 120V	(1) 50A, 2P, 120/240V (1) 20A, 1P, 120V	(1) 50A, 2P, 120/240V (1) 30A, 1P, 120V (1) 20A, 1P, 120V	(1) 50A, 2P, 120/240V (1) 30A, 1P, 120V (1) 20A, 1P, 120V

Please consult serving utility for their requirements prior to ordering or installing, as specifications and approvals vary by utility, and may require local electrical inspector approval. All installations must be installed by a licensed electrician and must comply with all national and local codes, laws and regulations. Milbank reserves the right to make changes in specifications and features shown without notice or obligation.











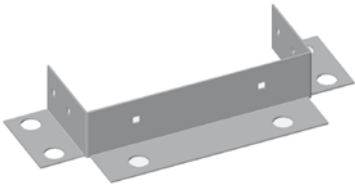

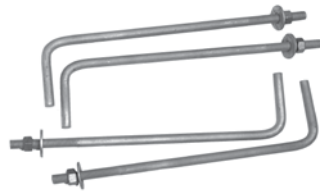
22

VOYAGER SERIES
ACCESSORIES &
REPLACEMENT
PARTS

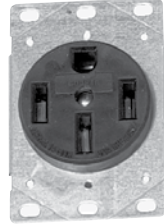
Voyager Series Pedestal Power Outlet

Accessories and Replacement Parts

			
<p>K5959 <i>Field-installed pad mount kit</i></p>	<p>K5415 <i>Stabilizer foot with hardware</i></p>		
	 <p><small>*subject to availability</small></p>		
<p>K5421 <i>Anchor bolt kit</i></p>	<p>CL200 <i>Analog E-Z read watt-hour meter</i></p>	<p>CL200-D <i>Digital E-Z read watt-hour meter</i></p>	
			
<p>Z708080-MO <i>20 Amps GFI receptacle NEMA 520</i></p>	<p>Z701776-MO <i>30 Amps receptacle NEMA TT30</i></p>	<p>Z708767-MO <i>50 Amps receptacle NEMA 1450</i></p>	
			
<p>Q120 <i>20 Amps, 1 pole circuit breaker</i></p>	<p>Q130 <i>30 Amps, 1 pole circuit breaker</i></p>	<p>Q250 <i>50 Amps, 2 pole circuit breaker</i></p>	



Please consult serving utility for their requirements prior to ordering or installing, as specifications and approvals vary by utility, and may require local electrical inspector approval. All installations must be installed by a licensed electrician and must comply with all national and local codes, laws and regulations. Milbank reserves the right to make changes in specifications and features shown without notice or obligation.

Voyager Series Pedestal Power Outlet

Accessories and Replacement Parts

23

VOYAGER SERIES
ACCESSORIES &
REPLACEMENT
PARTS

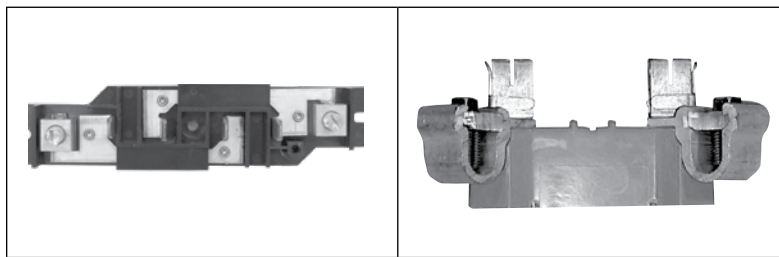

Z1050761
Circuit breaker base

Z915141-AC
Left or right meter block assembly

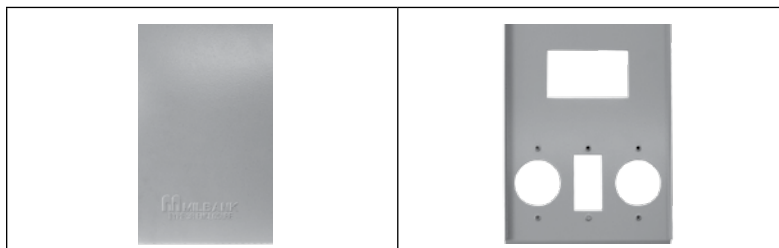

Z1144586
Hinge cover

Z1144587 (-75, shown)
Z1144921 (-41)
Z1144946 (-55)
Z1144947 (-332)
Deadfront



Z1144588
Circuit breaker bracket

MR-2
Snap-action sealing ring

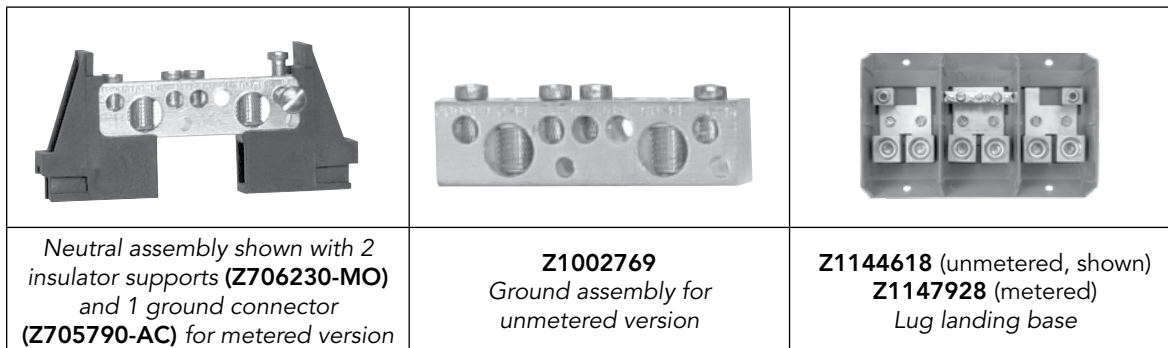

Neutral assembly shown with 2
insulator supports (**Z706230-MO**)
and 1 ground connector
(**Z705790-AC**) for metered version

Z1002769
Ground assembly for
unmetered version

Z1144618 (unmetered, shown)
Z1147928 (metered)
Lug landing base

Please consult serving utility for their requirements prior to ordering or installing, as specifications and approvals vary by utility, and may require local electrical inspector approval. All installations must be installed by a licensed electrician and must comply with all national and local codes, laws and regulations. Milbank reserves the right to make changes in specifications and features shown without notice or obligation.





Specifications

- Built in accordance with NEMA, ASA and AIEEE standards. Designed and tested to withstand 150% of rated load for two hours continuously.
- Integrated design of the enclosure, core and coil, and secondary distribution panel permits convenient vertical line and load terminations.
- Primary and/or secondary main circuit breaker protection available. Single fuse primary overcurrent protection provided on 2400 volt and above units. Second primary line fuse available if required.
- Other primary voltages available: 4160, 4800, 7200, 7960, & 12,470. Consult factory.

Core and Coil

- Aluminum wound (copper available)
- Standard voltage taps @ 2FCAN and 4FCBN
- Rated at 150°C temperature rise

Distribution Bus

- 1600 Amps tin plated aluminum
- Space available for up to (12) circuit breakers (1600 Amps maximum)
- Uses Milbank type UQFP-100 through 200 Amps circuit breakers

Enclosure

- Type 3R enclosure
- Powder coated galvanized steel (aluminum available)
- Lockable primary and secondary doors
- Fork lift slots provided

Dry Type Transformers

With distribution for RV & mobile home park applications

25
DRY TYPE
TRANSFORMERS

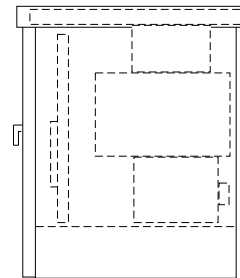
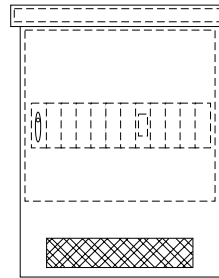
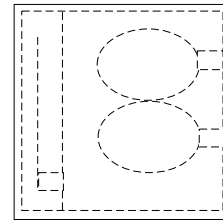
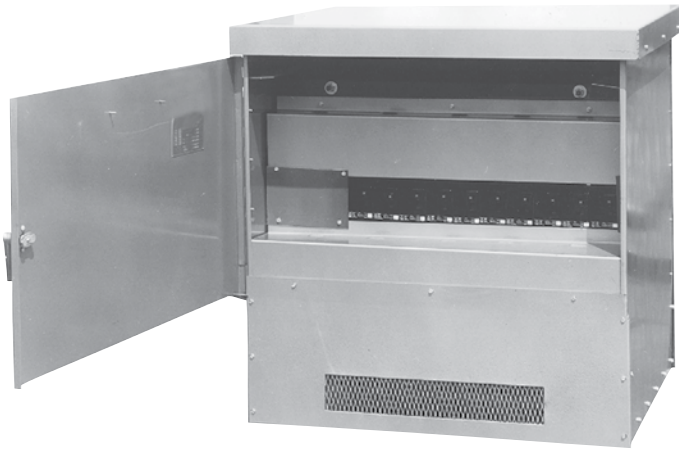

Distribution Transformers

Catalog Number	KVA	Volts to 120/240 1Ø	UL Listed	Weight (lbs.)	Dimensions		
					D"	W"	H"
7URMD	75	480	Yes	850	40	38	48
10URMD	100	480	Yes	1050	40	38	48
16URMD	167½	480	Yes	1400	40	38	48
20URMD	200	480	Yes	1650	40	38	48
25URMD	250	480	No	2200	40	38	48
7URMD24	75	2400	No	1050	53	41	48
10URMD24	100	2400	No	1200	53	41	48
16URMD24	167½	2400	No	1650	53	41	48
20URMD24	200	2400	No	1900	53	41	48
25URMD24	250	2400	No	2200	53	41	48

Notes

- **Replacement Bus Kit:** For a replacement bus kit, order **K5425**.

Please consult serving utility for their requirements prior to ordering or installing, as specifications and approvals vary by utility, and may require local electrical inspector approval. All installations must be installed by a licensed electrician and must comply with all national and local codes, laws and regulations. Milbank reserves the right to make changes in specifications and features shown without notice or obligation.



Pad Mounted Panel Boards

600/1200 Amps | 120/240 VAC



Specifications

- 600 to 1200 Amps, 120/240 volts, 1Ø distribution bus accepts up to (6) 2 pole, 200 Amps circuit breakers. Order from chart below.
- Costly main breaker not required per NEC 230-71.
- Economical alternative to costly wall hung or strut-mounted panel boards and load centers.
- Low profile, aesthetic design can be located near utility transformers or fed from a main service to a convenient location.
- Pad mounted Type 3R powder coated aluminum enclosure—standard color is gray.
- Hinge door and lift off rear service door are lockable and sealable for security.
- **Note:** Consult local code enforcement for pad size requirements. Order **CP-24-PDMNT-CALT** pad mount base or **CP-ABK5/8** anchor bolt kit separately.

Pad Mounted Panel Boards

Catalog Number	Amps	Phase	Volts	Connectors (Line)	Dimensions		
					D"	W"	H"
CP3B-AUX-1200	1200	1Ø	Yes	(3) 1-600 per phase or (3) 2-250 per phase	17	24	41



UQFP

Plug-In Circuit Breakers | 200 Amps Frame | 10K AIC | Two Pole Common Trip

Catalog Number	2-Pole Rating	Package Quantity	Wire Range	
			CU	AL
UQFP-100	100	1	#3-#1	#1-1/0
UQFP-125	125	1	#3-#1	#1-1/0
UQFP-150	150	1	1/0-300 kcmil	2/0-300 kcmil
UQFP-175	175	1	1/0-300 kcmil	2/0-300 kcmil
UQFP-200	200	1	1/0-300 kcmil	2/0-300 kcmil



Please consult serving utility for their requirements prior to ordering or installing, as specifications and approvals vary by utility, and may require local electrical inspector approval. All installations must be installed by a licensed electrician and must comply with all national and local codes, laws and regulations. Milbank reserves the right to make changes in specifications and features shown without notice or obligation.

Terminal Box

100–400 Amps | 120/240 Volts



U4540-XL

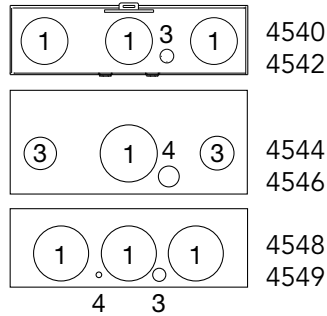
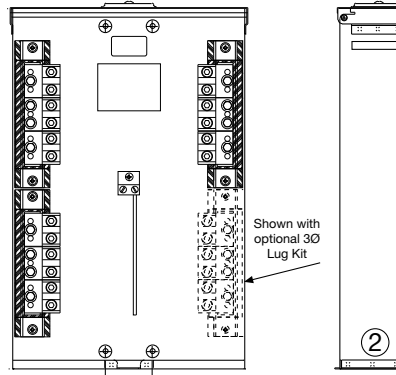

Terminal Boxes | 120/240 Volts

Catalog Number	Amps	Phase	Volts	Hub	Connectors CU7AL	1Ø to 3Ø Kit	Dimensions			Knockouts			
							D"	W"	H"	1	2	3	4
U4544-XL	100	1	120/240	C.P.	(6) #12-1/0	K4543	4 1/8	9 13/16	18	2	1	1/4, 1/2	—
U4546-XL	100	3	600	C.P.	(6) #12-1/0	N/A	4 1/8	9 13/16	18	2	1	1/4, 1/2	—
U4540-XL	200	1	120/240	C.P.	(6) #6-350	K4539	4 1/8	14 13/16	23	2 1/2	2 1/2	1 1/4	1/4, 1/2
U4542-XL	200	3	600	C.P.	(6) #6-350	N/A	4 1/8	14 13/16	23	2 1/2	2 1/2	1 1/4	1/4, 1/2
U4548-RXL	400	1	120/240	C.P.	(3) #6-350 or (2) #4-600	K4547	5	15 1/2	27	3	3	1/4, 1/2	1/4
U4549-RXL	400	3	600	C.P.	(3) #6-350 or (2) #4-600	N/A	5	15 1/2	27	3	3	1/4, 1/2	1/4

Notes

- **Hub:** Standard hub opening on top with closing plate attached.
- **Features:** UL Listed pad lockable Type 3R enclosure.
- **3Ø 120/240V Application:** Field installable 3Ø lug kit converts 1Ø unit to 3Ø unit.

Please consult serving utility for their requirements prior to ordering or installing, as specifications and approvals vary by utility, and may require local electrical inspector approval. All installations must be installed by a licensed electrician and must comply with all national and local codes, laws and regulations. Milbank reserves the right to make changes in specifications and features shown without notice or obligation.



Important Note

In addition to national and local electrical codes, many utilities have specific requirements for metering equipment. Always consult the serving utility for their specifications and requirements prior to ordering or installing Milbank meter mounting equipment.

Before Energizing

- A. Give equipment a thorough visual examination to determine that:
 - 1) No shipping or installation damage exists.
 - 2) Proper clearances have been maintained.
 - 3) All connections have been made.
 - 4) Equipment is clean and dry.
- B. Make a thorough examination to:
 - 1) Verify tightness of all bolted connections (see table below).
 - 2) Manually operate all circuit breakers, switches, relays, etc.
 - 3) Check rigidity of all mountings, bus bars and components.
 - 4) Use test equipment to check continuity of circuitry and integrity of insulation.
- C. All switches and circuit breakers should be in the "off" position.
- D. Verify that manual meter bypass (if applicable) is in non-bypass position.
- E. Install cover and/or close doors.
- F. If installation is not being energized at this time, follow "after-energizing" steps listed below. These steps will secure the installation in case of accidental energization.

When Energizing

- A. Use caution and follow established safety procedures:
 - 1) Wear safety apparel.
 - 2) Use safety equipment.
 - 3) Take action to prevent injury to yourself and others in the event of failure of the installation.
 - 4) Take action to prevent/decrease damage to property in the event of failure of the installation.
 - 5) If you are unsure how to safely energize the installation, get someone who is knowledgeable to do it.

After Energizing

- A. Secure the installation:
 - 1) To prevent accidental contact with energized parts, cover all openings with approved filler devices.
 - 2) To prevent unauthorized access, secure all covers and/or doors with approved security devices.
 - 3) Attach/post information to advise others of potential hazards associated with the installation.

Recommended Torque for General Applications*

Nominal Size	Joint Description		Head Type	Torque (Inch Lbs.)
	Screw	Nut		
10	Brass	Brass Nut or Extruded Hole	All	20-25 inch lbs.
10	Steel	Copper or Aluminum Busbar ≤ 1/8"	All	25-30 inch lbs.
10	Steel	Steel Nut or Extruded Hole; CU or AL Busbar > 1/8"	All	30-35 inch lbs.
12	Steel	Aluminum Extruded Hole	All	30-35 inch lbs.
12	Steel	Steel Nut or Extruded Hole	All	40-50 inch lbs.
1/4	Steel	Aluminum Extruded Hole	All	40-50 inch lbs.
1/4	Steel	Steel Nut or Extruded Hole; CU or AL Busbar	All	50-60 inch lbs.
5/16	Steel	Aluminum Extruded Hole	Hex	60-70 inch lbs.
5/16	Steel	Steel Nut or Extruded Hole; CU or AL Busbar	Hex	100-150 inch lbs.
3/8	Steel	Steel Nut	Hex	150-200 inch lbs.
1/2	Steel	Steel Nut	Hex	200-250 inch lbs.

* Interior labels typically indicate the required torque for wire connectors and studs, and should be referenced first.
CU: Copper
AL: Aluminum



Please consult serving utility for their requirements prior to ordering or installing, as specifications and approvals vary by utility, and may require local electrical inspector approval. All installations must be installed by a licensed electrician and must comply with all national and local codes, laws and regulations. Milbank reserves the right to make changes in specifications and features shown without notice or obligation.

10URMD	25	K5920-75	14	U5200-XL-75.....	9	UQPF-175.....	26
10URMD24	25	K5920-BLANK	14	U5210-XL.....	9	UQPF-200.....	26
16URMD	25	K5959	22	U5220-XL.....	9	Z1002769.....	23
16URMD24	25	K6212	15	U5220-XL-41.....	9	Z1050761.....	23
20URMD	25	K6213	15	U5220-XL-75.....	9	Z1144586.....	23
20URMD24	25	MR-2	23	U5230-XL.....	9	Z1144587.....	23
25URMD	25	MR-2	19	U5300-O.....	11	Z1144588.....	23
25URMD24	25	P-10GWR.....	18	U5300-O-41.....	11	Z1144618.....	23
708784-MO	19	P-13	18	U5300-O-55.....	11	Z1144921.....	23
7URMD	25	P-54	18	U5300-O-75.....	11	Z1144946.....	23
7URMD24	25	Q120.....	7,19	U5310-O.....	11	Z1144947.....	23
CL200	18,22	Q130.....	19,22	U5320-O.....	11	Z1147928.....	23
CL200-D	22	Q250.....	19,22	U5320-O-75.....	11	Z701776-MO	19,22
CP3B-AUX-1200	26	U4540-XL.....	27	U5330-O.....	11	Z705790-AC	19,23
K4709-02	16	U4542-XL.....	27	U5950-O-332.....	21	Z706230-MO	19,23
K4709-02-3R.....	16	U4544-XL.....	27	U5950-O-41.....	21	Z707365-SC.....	19
K4709-WS.....	16	U4546-XL.....	27	U5950-O-55.....	21	Z708080-MO	19,22
K4800-01	18	U4548-RXL.....	27	U5950-O-75.....	21	Z708767-MO	19,22
K5410	17	U4549-RXL.....	27	U5951-O-332.....	21	Z818052-SC	19
K5413	15	U5000-XL.....	5	U5951-O-41.....	21	Z818480-SC.....	19
K5415	22	U5000-XL-332.....	5	U5951-O-55.....	21	Z915141-AC	19,23
K5415	17	U5000-XL-41.....	5	U5951-O-75.....	21	Z917602-AC	19
K5421	22	U5000-XL-55.....	5	U5952-O-332.....	21	Z918447-AC	19
K5421	17	U5000-XL-75.....	5	U5952-O-41.....	21	Z918449-AC	19
K5920	22	U5100-XL.....	7	U5952-O-55.....	21	Z918466-AC	19
K5920-10GR.....	14	U5100-XL-41.....	7	U5952-O-75.....	21		
K5920-111GR.....	14	U5100-XL-55.....	7	U5953-O-332.....	21		
K5920-11GR.....	14	U5100-XL-75.....	7	U5953-O-41.....	21		
K5920-38	14	U5101-XL.....	7	U5953-O-55.....	21		
K5920-41	14	U5200-XL.....	9	U5953-O-75.....	21		
K5920-522.....	14	U5200-XL-332.....	9	UQPF-100.....	26		
K5920-54	14	U5200-XL-41.....	9	UQPF-125.....	26		
K5920-58	14	U5200-XL-55.....	9	UQPF-150.....	26		

Please consult serving utility for their requirements prior to ordering or installing, as specifications and approvals vary by utility, and may require local electrical inspector approval. All installations must be installed by a licensed electrician and must comply with all national and local codes, laws and regulations. Milbank reserves the right to make changes in specifications and features shown without notice or obligation.



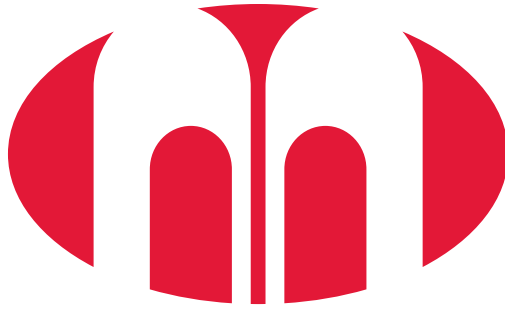

MILBANK[®]

ENERGY AT WORK

