

MILBANK[®]
ENERGY AT WORK



ARKANSAS **W. TENNESSEE** N. MISSISSIPPI

Meter Mounting Equipment



Meter mounting
equipment approved
for use within the
Arkansas, W. Tennessee,
and N. Mississippi region.

Milbank Overview

Energy At Work Since 1927

Milbank designs and manufactures electrical solutions that move and manage power for the residential, commercial, industrial, utility and transportation sectors. With nearly a century of expertise in electrical engineering design and manufacturing, Milbank's portfolio includes metering equipment, enclosures and enclosed controls. Founded in 1927, Milbank is a family-owned, American manufacturer headquartered in Kansas City, Mo. For more information, please visit milbankworks.com.



Metering

Milbank has been a market leader in electrical metering equipment, setting the standard in quality, for 95 years and counting. There are hundreds of available configurations, including a range of sizes as well as various knockout, terminals and bypass options. Products also have a variety of selections for hubs, locks and connectors. Milbank has the socket you need with thousands of active products to meet your utility's requirements.



Enclosures

Milbank's line of enclosures include commercial junction boxes, panel mount enclosures, transformer cabinets, wireways and troughs. Enclosures are designed to meet or exceed industry standards. Each one is constructed with high-quality materials and built with superior craftsmanship. Each unit is engineered to protect controls and equipment from dust, dirt and other harmful elements, based on various NEMA ratings.



Enclosed Controls

Milbank doesn't just build empty enclosures, we can design and craft the entire package. Our enclosed controls are custom control equipment, engineered and built to your exact specifications. Milbank enclosed controls are an attractive, secure, Easy to install and cost-effective solution. These units can replace unsightly and insufficient strut and backboard structures when underground remote site power distribution and control equipment is required.



Please consult serving utility for their requirements prior to ordering or installing, as specifications and approvals vary by utility, and may require local electrical inspector approval. All installations must be installed by a licensed electrician and must comply with all national and local codes, laws and regulations. Milbank reserves the right to make changes in specifications and features shown without notice or obligation.

Air Conditioner Disconnects

30-60 Amps AC Disconnects	6
60 Amps AC Disconnect with 20 Amps GFCI Receptacle	7
Hot Tub Disconnects	8

Single Position Sockets

125 Amps, 4-5 Terminals	8
-------------------------------	---

Single Position with Lever Bypass

200 Amps, 5-7 Terminals	9
320 Amps, 4 Terminals	13
320 Amps, 5-7 Terminals	14

K Base Bolt-In Meter Socket

4-7 Terminals	15
Lugs for K Base	16

Unmetered Power Outlet

100-200 Amps	17
--------------------	----

Meter Mains with Load Center

100-200 Amps, 4 Terminals	18
---------------------------------	----

Cold Sequence

200 Amps, 7 Terminals, Heavy Duty Lever Bypass, Ringless	19
--	----

Multi-Position Sockets

100 Amps, 4-5 Terminals, Ringless	20-22
100 Amps, 4 Terminals, Vertical, Ringless	23
150 Amps, 4 Terminals	24
200 Amps, 4 Terminals	25-27

Multi-Position Meter Mains

200 Amps, 4 Terminals, Ringless	28
100-200 Amps, 4 Terminals, Ringless, 22K	29-30

Please consult serving utility for their requirements prior to ordering or installing, as specifications and approvals vary by utility, and may require local electrical inspector approval. All installations must be installed by a licensed electrician and must comply with all national and local codes, laws and regulations. Milbank reserves the right to make changes in specifications and features shown without notice or obligation.



Transformer Rated

20 Amps, CT-Rated Socket	31
CT Cabinets	32

Pedestals

200 Amps, 4 Terminals, Ringless	34-35
---------------------------------------	-------

Miscellaneous

Circuit Breakers	36-37
Accessories	38-40
Utility Approval List	41-42
Commercial Pedestals.....	43-44
Reference Information	47-51
Index.....	52-53



Please consult serving utility for their requirements prior to ordering or installing, as specifications and approvals vary by utility, and may require local electrical inspector approval. All installations must be installed by a licensed electrician and must comply with all national and local codes, laws and regulations. Milbank reserves the right to make changes in specifications and features shown without notice or obligation.

Catalog Number Logic

How Our Product Catalog Numbers are Derived

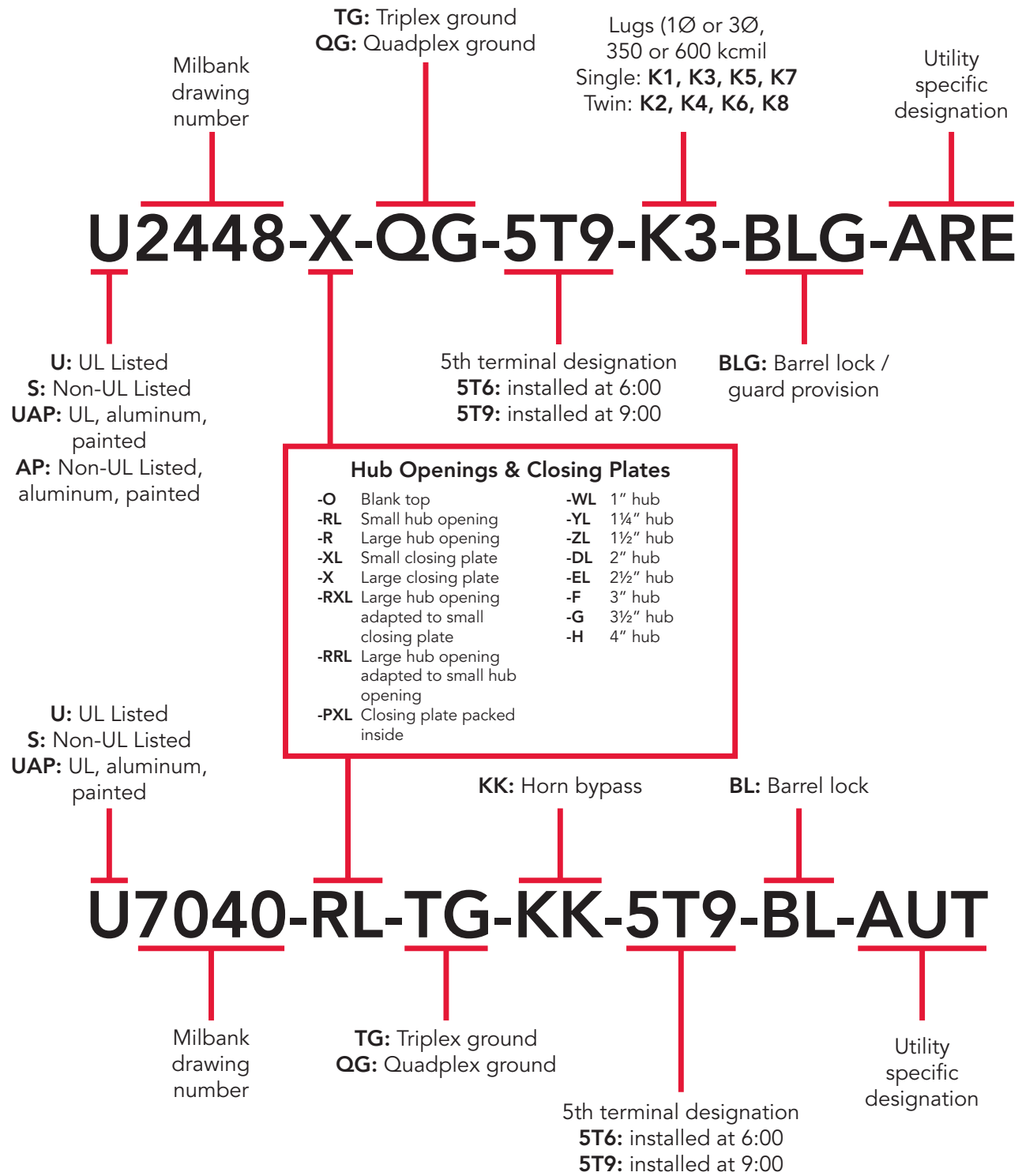

Please consult serving utility for their requirements prior to ordering or installing, as specifications and approvals vary by utility, and may require local electrical inspector approval. All installations must be installed by a licensed electrician and must comply with all national and local codes, laws and regulations. Milbank reserves the right to make changes in specifications and features shown without notice or obligation.





U3802



U3812



U3832

Milbank's air conditioner disconnect has a removable hinged cover that makes wiring a breeze. Our compact design meets NEC wiring space requirements and also complies with NEC article 440-14. For safe working conditions, our disconnect pullers may be removed and reinstalled in the OFF position. Additionally, padlock provisions are included on the front cover. As with other Milbank products, our enclosure is constructed of G90 galvanized steel and electrostatically finished with an attractive, light gray, baked powder coating. Our epoxy/polyester resin blend offers a finish that is both durable and fade-resistant.

30-60 Amps | Air Conditioner Disconnects | 1Ø 240V

Catalog Number	Amps	Type	Max H.P.	Weight (lbs.)	Line/Load Wire Range		Ground Wire Range CU/AL	Dimensions			Wire Rating	
					CU	AL		D"	W"	H"	CU °C	AL °C
U3802	60	Non-Fusible	10	3.25	#14-#2	#12-#2	#14-4	2½	5	7½	60°/75°	60°/75°
U3812	60	Non-Auto	10	3.25	#14-#2	#12-#2	#14-4	2½	5	7½	60°/75°	60°/75°
U3832	30	Fusible	3	2.5	#14-#3	#14-#3	#14-3	2⅞	5	7	60°/75°	60°
U3862	60	Fusible	10	3.3	#14-#3	#14-#3	#14-3	2⅞	5	9	60°/75°	60°/75°

Notes

- UL-listed as Enclosed Pullout Switch
- NEMA 3R
- Weather-resistant
- One-inch concentric knockouts



Please consult serving utility for their requirements prior to ordering or installing, as specifications and approvals vary by utility, and may require local electrical inspector approval. All installations must be installed by a licensed electrician and must comply with all national and local codes, laws and regulations. Milbank reserves the right to make changes in specifications and features shown without notice or obligation.

Air Conditioner Disconnects

60 Amps | With 20 Amps GFCI Receptacle



U3822-20GWR

Specifications

- Meets NEC #406.8 requirements
- Meets NEC #210.63 requirements
- UL-listed as Power Outlet
- NEMA 3R
- In-use cover*
- Duplex ground connector
- One-inch concentric knockouts
- 1Ø, 240V
- 60 Amps, non-fused
- 20 Amps GFCI receptacle
- Reset/test button
- Weather-resistant

60 Amps | Air Conditioner Disconnect with 20 Amps GFCI Receptacle | 1Ø, 240V

Catalog Number	Type	Max H.P.	Weight (lbs.)	Line/Load Wire Range		Ground Wire Range CU/AL	Dimensions			Wire Rating	
				CU	AL		D"	W"	H"	CU °C	AL °C
U3822-20GWR	Non-Fusible	10	6	#14-#2	#12-#2	#14-4	4 ¹ / ₈	5 ¹ / ₄	7 ³ / ₈	60°/75°	60°/75°

Notes

- **Disconnect-pullers:** To ensure the safest conditions, Milbank disconnect pullers are reversible so they may be reinstalled in the OFF position.
 - **Padlock:** All units are designed with a padlock provision on the cover for security.
- *Rated as an in-use cover (cover may be closed with cords plugged into receptacle).

Please consult serving utility for their requirements prior to ordering or installing, as specifications and approvals vary by utility, and may require local electrical inspector approval. All installations must be installed by a licensed electrician and must comply with all national and local codes, laws and regulations. Milbank reserves the right to make changes in specifications and features shown without notice or obligation.



Single Position Sockets

125-200 Amps | 4 Terminals | Ringless | 600V



U8435-RL-TG



U1980-O

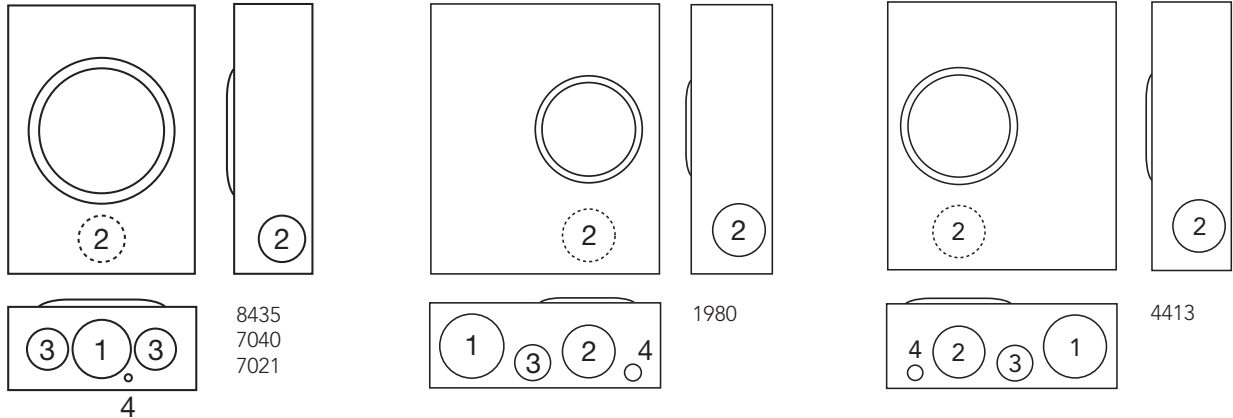

125-200 Amps | 4 Terminals | Ringless

Catalog Number	Amps	Service	Hub	Connectors CU/AL		Dimensions			Knockouts					
				Line	Load	D"	W"	H"	1	2	3	4	5	6
U8435-RL-TG	125	OH/UG	H.O.	#6-2/0	#6-2/0	3 ⁵ / ₁₆	8	11 ¹ / ₂	1 ¹ / ₂	1 ¹ / ₂	2	1 ¹ / ₄	—	1 ¹ / ₄
U7021-RL-TG	200	OH	H.O.	#6-350 kcmil	#6-350 kcmil	4 ¹ / ₈	8	15 ¹ / ₂	2 ¹ / ₂	2 ¹ / ₂	2 ¹ / ₂	—	1 ¹ / ₄	1 ¹ / ₄ , 1 ¹ / ₂
U7040-RL-TG	200	OH/UG	H.O.	#6-350 kcmil	#6-350 kcmil	4 ¹ / ₈	11	14 ⁹ / ₁₆	2 ¹ / ₂	2 ¹ / ₂	2 ¹ / ₂	2 ¹ / ₂	1 ¹ / ₄ , 1 ¹ / ₂	1 ¹ / ₄
U1980-O	200	UG	Blank	#6-350 kcmil	#6-350 kcmil	4 ¹ / ₂	13	15 ¹ / ₄	2 ¹ / ₂	2 ¹ / ₂	3	1 ¹ / ₂	2 ¹ / ₂	1 ¹ / ₄ , 1 ¹ / ₂
U4413-O	200	UG	Blank	#6-350 kcmil	#6-350 kcmil	4 ¹ / ₂	13	15 ¹ / ₄	2 ¹ / ₂	2 ¹ / ₂	2 ¹ / ₂	3	1 ¹ / ₂	1 ¹ / ₄ , 1 ¹ / ₂

Notes

- **Hubs:** For proper hub selection see the hub suffix chart on the accessory page.
- **Fifth Terminal:** For field mounted fifth terminal, order catalog number **K5T** to fit into square opening at the 9 o'clock position of the *new style block* (#6-350 kcmil). Order catalog number **5T8K2** to fit into round opening at the 9 o'clock position of the *old style block* (#2-350 kcmil). Order catalog number **5T8K2** for **U8435**. For the **U7040** and **U1980-O**, order catalog number **K5T**.
- **Connectors:** Extruded aluminum connectors are tin plated. **U8435**, **U7021**, and **U7040** are supplied with triplex neutral.



Please consult serving utility for their requirements prior to ordering or installing, as specifications and approvals vary by utility, and may require local electrical inspector approval. All installations must be installed by a licensed electrician and must comply with all national and local codes, laws and regulations. Milbank reserves the right to make changes in specifications and features shown without notice or obligation.

Lever Bypass Single Position

200 Amps | 5-7 Terminals | Ringless



U4581-RL-QG



U4701-RL-QG



U4184-X

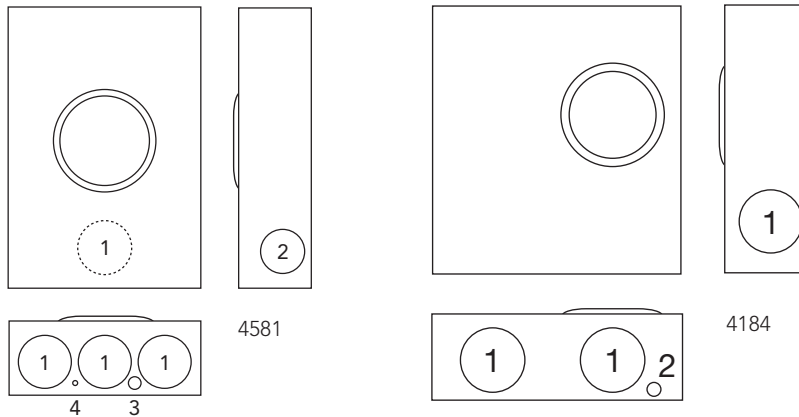

200 Amps | 5-7 Terminals | Ringless | Heavy Duty Lever Bypass | 600V | OH/UG Service

Catalog Number	Terminals	Hub	Connectors CU/AL		Dimensions			Knockouts					
			Line	Load	D"	W"	H"	1	2	3	4	5	6
U4581-RL-QG	5	H.O.	#6-350 kcmil	#6-350 kcmil	4 ⁷ / ₈	13	19	3	2 ¹ / ₂	3	3	1/4	1/4, 1/2
U4701-RL-QG	7	H.O.	#6-350 kcmil	#6-350 kcmil	4 ⁷ / ₈	13	19	3	2 ¹ / ₂	3	3	1/4	1/4, 1/2
U4184-X*	7	C.P.	#6-350 kcmil	#6-350 kcmil	6	18	19 ¹ / ₄	4	4	1/4, 1/2	—	—	—

Notes

- **Connectors:** Extruded aluminum connectors are tin plated.
- The **U4581** has a manual center disconnect on the neutral/center phase.
- **Lever Bypass:** Lever supplies clamping action and operates bypass device.
- **Bonding Link:** **U4581-RL-QG** is factory bonded. Can be field isolated.
- ***Side Wireway**

Please consult serving utility for their requirements prior to ordering or installing, as specifications and approvals vary by utility, and may require local electrical inspector approval. All installations must be installed by a licensed electrician and must comply with all national and local codes, laws and regulations. Milbank reserves the right to make changes in specifications and features shown without notice or obligation.



1 □

Lever Bypass Single Position

320 Amps | 4-5 Terminals | HD Lever Bypass | Ringless

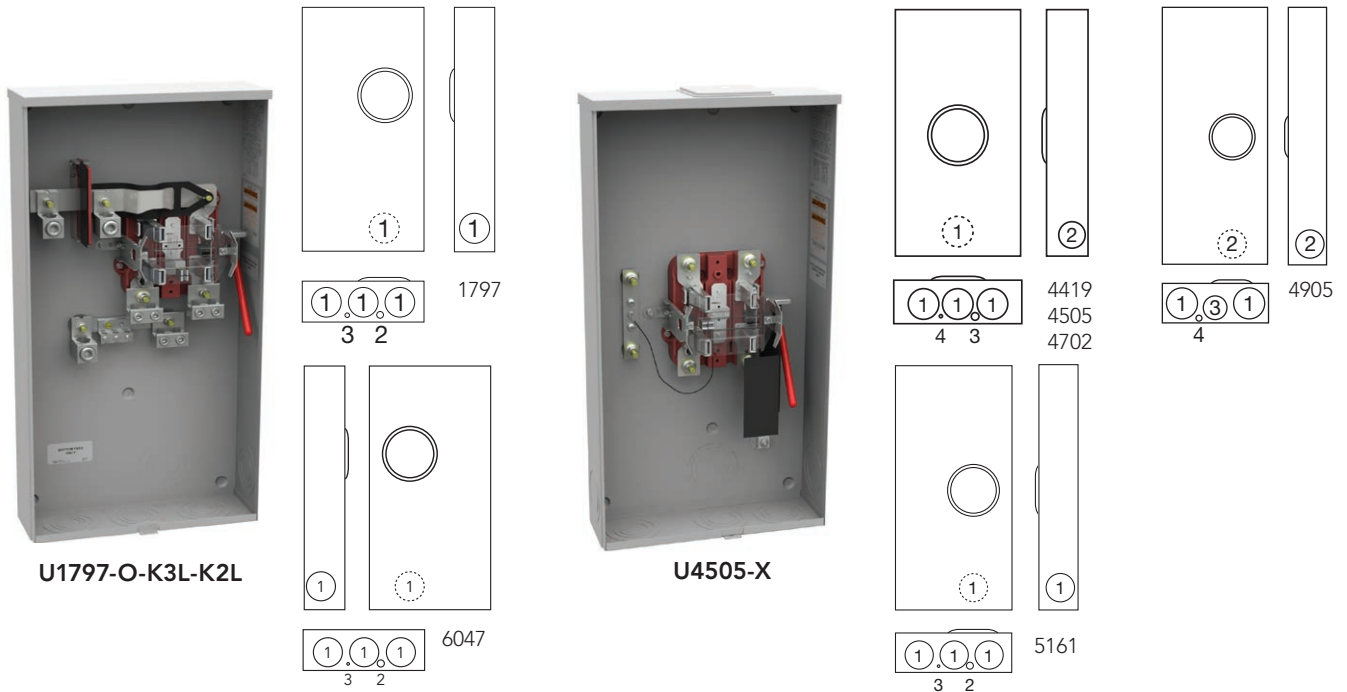

320 Amps | 4-5 Terminals | Ringless | Lever Bypass | 600V

Catalog Number	Terminals	Service	Hub	Connectors CU/AL		Dimensions			Knockouts			
				Line	Load	D"	W"	H"	1	2	3	4
U4702-X	4	OH/UG	C.P.	3/8" -16 Stud	3/8" -16 Stud	4 7/8	15	28 1/4	3	1/4, 1/2	1/4	—
U4905-X*	4	OH/UG	C.P.	3/8" -16 Stud	3/8" -16 Stud	5 3/4	16	38 3/4	4	3 1/2	3	1/2
U1797-O-K3L-K2L*	4	UG	Blank	(1) #4-600 or (2) 1/0-250	Twin #6-350	4 7/8	15	30	3	1/2	1/4	—
U6047-O-K3L-K2L*	4	UG	Blank	(1) #4-600 or (2) 1/0-250	Twin #6-350	4 7/8	15	30	3	1/2	1/4	—
U4505-X	5	OH/UG	C.P.	3/8" -16 Stud	3/8" -16 Stud	4 7/8	15	28 1/4	3	3	1/2	1/4
U4419-X	5	OH/UG	C.P.	3/8" -16 Stud	3/8" -16 Stud	4 7/8	15	29	3	2 1/2	1/2	1/4

Notes

- **Hubs:** For proper hub selection see the hub suffix chart on the accessory page.
- **Lever Bypass:** Lever supplies clamping action and operates bypass device.
- **Connectors:** Stud type units supplied with 3/8" -16 hex head nuts with Belleville washers. For single lug connector kits, order as extra **K1539** (350 kcmil), **K3082** (350 kcmil) or **K3441** (600 kcmil). For twin lug connectors order as extra **K1350** (350 kcmil) or **K3442** (350 kcmil). Separate kits are required for both line and load.
- **Disconnect:** The **U4419** has a manual center disconnect on the neutral / center phase.
- **Phases:** The **U4505** and **U4419** are 1Ø3W or 3Ø3W.
- **Fifth Terminal:** For field-installed fifth terminal order catalog no. **K3865**.

*Side Wireway



Please consult serving utility for their requirements prior to ordering or installing, as specifications and approvals vary by utility, and may require local electrical inspector approval. All installations must be installed by a licensed electrician and must comply with all national and local codes, laws and regulations. Milbank reserves the right to make changes in specifications and features shown without notice or obligation.

Lever Bypass Single Position

1 1

320 Amps | 7 Terminals | HD Lever Bypass | Ringless

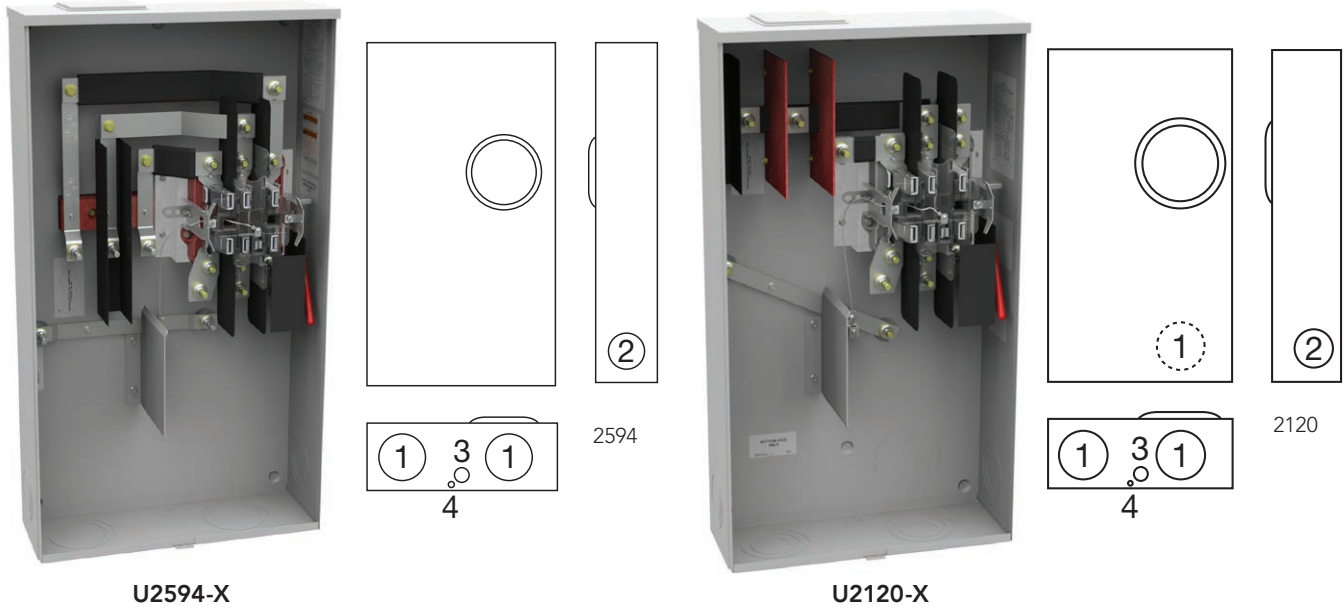

320 Amps | 7 Terminals | Side Wireway | Ringless | 3Ø4W

Catalog Number	Service	Hub	Connectors CU/AL		Bypass	Dimensions			Knockouts			
			Line	Load		D"	W"	H"	1	2	3	4
U2594-X	OH/UG	C.P.	3/8"-16 Stud	3/8"-16 Stud	Lever	6 1/2	19	34 1/8	4	3	1	1/4
U2120-X	UG	C.P.	3/8"-16 Stud	3/8"-16 Stud	Lever	6 1/2	17 3/4	31 3/4	4	3	1	1/4

Notes

- **Hubs:** For proper hub selection see the hub suffix chart on the accessory page.
- **Lever Bypass:** Lever supplies clamping action and operates bypass device.
- **Connectors:** Stud type units supplied with 3/8"-16 hex head nuts with Belleville washers. For single lug connector kits, order as extra: **K3082** (350 kcmil) or **K3441** (600 kcmil). For twin lug connectors order as extra: **K3442** (350 kcmil). Separate kits are required for both line and load.

Please consult serving utility for their requirements prior to ordering or installing, as specifications and approvals vary by utility, and may require local electrical inspector approval. All installations must be installed by a licensed electrician and must comply with all national and local codes, laws and regulations. Milbank reserves the right to make changes in specifications and features shown without notice or obligation.



Load Center and Meter Mains

100-200 Amps | 120/240V

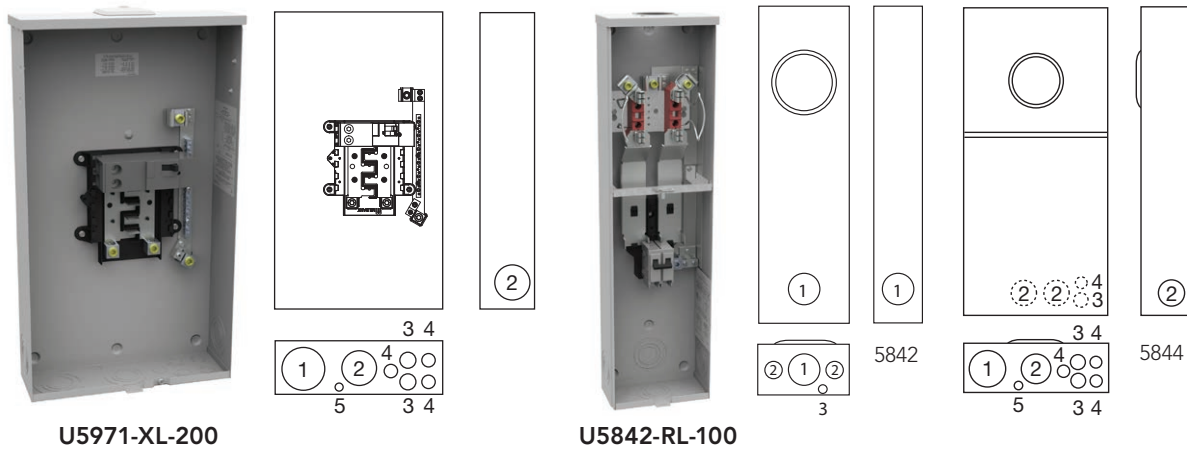

100-200 Amps | Load Center with Main Breaker | 120/240V

Catalog Number	Main Breaker Amp	Branch Circuits	Service	Hub	Dimensions			Knockouts				
					D"	W"	H"	1	2	3	4	5
U5971-XL-100	100	10	OH/UG	C.P.	4½	14⅞	25⅙	3	2½	1	½,¾	¼,½
U5971-XL-150	150	8	OH/UG	C.P.	4½	14⅞	25⅙	3	2½	1	½,¾	¼,½
U5971-XL-200	200	8	OH/UG	C.P.	4½	14⅞	25⅙	3	2½	1	½,¾	¼,½

4 Terminals | Ringless Meter Main Models

Catalog Number	Amps	Term	Service	WT (#)
U5842-RL-100	100	4	OH	26
U5842-RL-200	200	4	OH	26
U5844-PXL	200	4	OH/UG	37
U5844-PXL-100	100	4	OH/UG	37
U5844-PXL-150	150	4	OH/UG	37
U5844-PXL-200	200	4	OH/UG	37

Notes

- **AIC Rating:** All models are rated 22K AIC when Siemens breakers are used.
- **Hub:** OH/UG units supplied with one (1) closing plate packed inside.
- **Fifth Terminal:** For field-installed 208Y/120 network service order **K5T**. Installs in the 9 o'clock position.

Main Circuit Breaker Chart

Amperage	100	150	200
10KAIC Breaker Model	Q2100	QN2150	QN2200
22KAIC Breaker Model	Q2100H	QN2150H	QN2200H



Please consult serving utility for their requirements prior to ordering or installing, as specifications and approvals vary by utility, and may require local electrical inspector approval. All installations must be installed by a licensed electrician and must comply with all national and local codes, laws and regulations. Milbank reserves the right to make changes in specifications and features shown without notice or obligation.

Meter Main with Load Center

13

100-200 Amps | 4 Terminals | Ringless



U5168-XTL-200

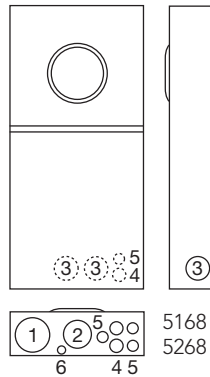

5168
5268



U5898-O-200

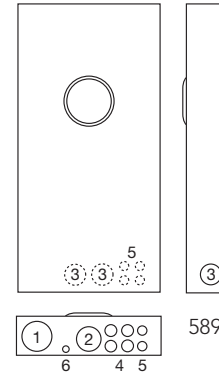

5898

100-200 Amps | 4 Terminals | Meter Main | OH/UG Service | 22K AIC | 120/240V | 1Ø3W

Catalog Number	Avail. Circuits	Hub	Connectors CU/AL		Dimensions			Knockouts					
			Line	Load	D"	W"	H"	1	2	3	4	5	6
U5168-XTL-100**	10	C.P.	#6-350 kcmil	#6-350 kcmil Breaker	4½	14⅞	30	2	2	3	2½	½, ¾, 1	½, ¾
U5168-XTL-150**	8	C.P.	#6-350 kcmil	#6-350 kcmil Breaker	4½	14⅞	30	2	2	3	2½	½, ¾, 1	½, ¾
U5168-XTL-200**	8	C.P.	#6-350 kcmil	#6-350 kcmil Breaker	4½	14⅞	30	2	2	3	2½	½, ¾, 1	½, ¾
U5268-XTL-200	20	C.P.	#6-350 kcmil	Breaker	4½	14⅞	30	2	2	3	2½	½, ¾, 1	½, ¾
*U5898-O-200**	8	C.P.	#6-350 kcmil	#6-350 kcmil Breaker	4½	17	34½	2	3	2½	1	½, ¾	¼, ¾

Notes

- **Hub:** Supplied with (2) closing plates inside. Order hubs as a separate item. See accessory page for hub options and twin hub openings. The **U5898-O-200** has no hub opening on the top.
- **Interior:** **U5168** and **U5898** units have 8-circuit interior; **U5268** units have 20-circuit interior.
- **Fifth Terminal:** Order **K5T** and field install for 208Y/120 network systems. Installs in the 9 o'clock position only for **U5168** and **U5268**.
- **Main Breakers:** Rated 22K AIC.
- **Interlock Kit:** For generator auxiliary circuit breaker interlock, order **K5815** for large **QN** with small frame **Q**; order **K5820** for large frame **QN** with large frame **QN**. **K5830** for small frame **Q** with small frame **Q**.
- **Sub-Feed Lugs:** #6-350 kcmil sub-feed lugs provided on 8-circuit interior. Order **K3701** for 20-circuit interior.

*Side Wireway

**Feed through Lugs

Branch Breaker Chart

AIC Rating	Amps	Siemens	Cutler-Hammer	General Electric	Square D
10k	150-200	QNR	BR (150A only)	—	—
	≤ 125	QP	HQP, BR	THQL, THQL-GF	Homeline
22k	150-200	QNRH	—	—	—
	≤ 125	QPH	—	—	—

Please consult serving utility for their requirements prior to ordering or installing, as specifications and approvals vary by utility, and may require local electrical inspector approval. All installations must be installed by a licensed electrician and must comply with all national and local codes, laws and regulations. Milbank reserves the right to make changes in specifications and features shown without notice or obligation.



200 Amps | 7 Terminals | Ringless | 120/208V

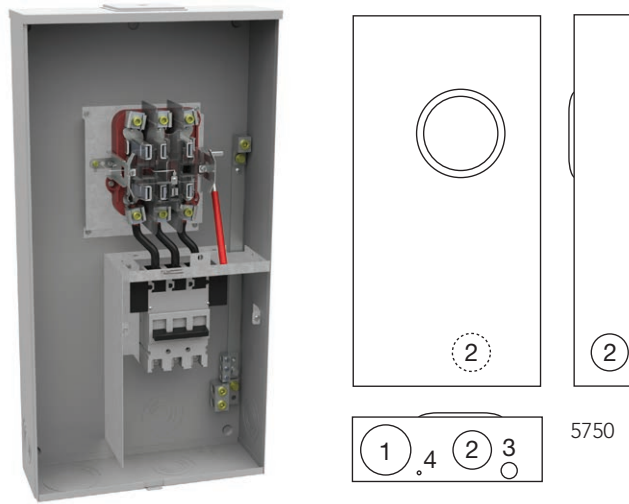

U5750-RXL-200-BL

200 Amps | 7 Terminals | Lever Bypass | Meter Main | Ringless | 3Ø4W

Catalog Number	Amps	Hub	Connectors CU/AL		Dimensions			Knockouts			
			Line	Load	D"	W"	H"	1	2	3	4
U5750-RXL-200-BL	200	C.P.	#6-350	C/B	5¾	17¾	34	4	3	1	¼

Notes

- **Hubs:** For proper hub selection see the hub suffix chart on the accessory page.
- **Bypass:** The lever supplies clamping action on the meter spade and also operates the bypass device.
- **Breaker:** Factory-installed 200 Amps, 3-pole, 10,000 AIC.



Please consult serving utility for their requirements prior to ordering or installing, as specifications and approvals vary by utility, and may require local electrical inspector approval. All installations must be installed by a licensed electrician and must comply with all national and local codes, laws and regulations. Milbank reserves the right to make changes in specifications and features shown without notice or obligation.

Meter Main

320 Amps | 4 Terminals | Ringless

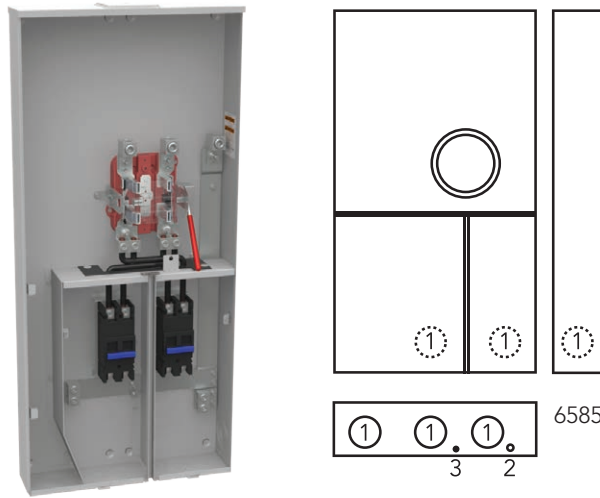

U6585-X-2/200-K3L-5T9-AMS

320 Amps Meter Main with Breakers | 1Ø3W | Ringless | 120/240V

Catalog Number	Service	Hub	Connectors CU/AL		Fifth Term. Kit	Bypass	Dimensions			Knockouts		
			Line	Load			D"	W"	H"	1	2	3
U6585-X-2/200-K3L	OH/UG	C.P.	#4-600 kcmil	#1/0-300 kcmil	K3866	Lever	4 ⁷ / ₈	20 ¹ / ₄	45	3	1/4, 1/2	1/4

Notes

- **Lever Bypass:** Lever supplies clamping action and operates bypass device.
- ***Breakers:** Supplied with (2) Milbank **UQFPH-200** breakers rated at 22K AIC.

320 Amps Meter Main with Breakers | Lever Bypass | 1Ø3W | Ringless | 120/240V

Catalog Number	Service	Hub	Connectors CU/AL		Fifth Term. Kit	Side Buss	Dimensions			Knockouts			
			Line	Load			D"	W"	H"	1	2	3	4
U6601-X-2/200	OH/UG	C.P.	Studs	#1/0-300	K3865	None	6	24 ¹ / ₂	35	4	2 ¹ / ₂	1/4	
U6602-X-2/200	OH/UG	C.P.	Studs	#1/0-300	K3865	None	6	38	41	4	2 ¹ / ₂	1/4, 1/2	1/4
U6603-X-2/200	OH/UG	C.P.	Studs	#1/0-300	K3865	Yes	6	38	41	4	2 ¹ / ₂	1/4, 1/2	1/4
U6605-X-2/200-MLK-ENT	OH/UG	C.P.	Studs	#1/0-300	K3865	Yes	6	29 ¹ / ₂	35	4	2 ¹ / ₂	1	1/4, 1/2

Notes

- **Breakers:** U6601-X-2/200 installed with **QN2200H** breakers. U6605-X-2/200-MLK-ENT installed with left breaker **QN2200H** and right breaker **QN2200RH**.
- **Connectors:** Sockets are supplied with 3/8" - 16 hex head nuts with Belleville washers. For connector lug kits, order as extra from chart on accessory page. Lug kit required for line side only.
- **OH/UG:** Is dependent upon utility specifications.
- ¹ **Sub-Feed Lugs:** #6-350 kcmil sub-feed lugs provided on 8-circuit interior. Order **K3701** for 20-circuit interior or **-MLK** for factory-installed.
- ² **Side Wireway**
- *12-circuit load center
- **24-circuit load center

Please consult serving utility for their requirements prior to ordering or installing, as specifications and approvals vary by utility, and may require local electrical inspector approval. All installations must be installed by a licensed electrician and must comply with all national and local codes, laws and regulations. Milbank reserves the right to make changes in specifications and features shown without notice or obligation.



320 Amps Meter Mains

Single 400 Amps Main Breaker



U6228-X-400



U6230-X-400

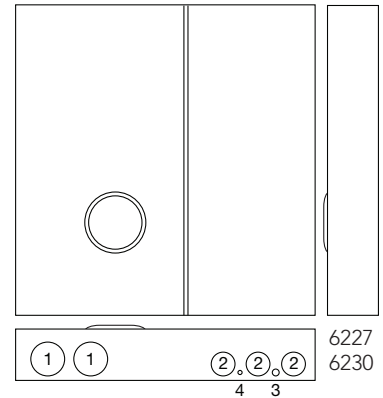

400 Amps Meter Main | 4 Terminals | 1Ø3W | 480V

Catalog Number	Service	Hub	Connectors CU/AL		Bypass	Dimensions			Knockouts			
			Line	Load		D"	W"	H"	1	2	3	4
U6227-X-400	OH/UG	CP	Stud	(2) 3/0-500	Lever	6	36¼	34	4	2½	½	¼
U6228-X-400	OH/UG	CP	Stud	(2) 3/0-500	Lever	6	36¼	34	4	2½	½	¼

400 Amps Meter Main | 7 Terminals | 3Ø4W | 480V

Catalog Number	Service	Hub	Connectors CU/AL		Bypass	Dimensions			Knockouts			
			Line	Load		D"	W"	H"	1	2	3	4
U6229-X-400	OH/UG	CP	Stud	(2) 3/0-500	Lever	6	36¼	34	4	2½	½	¼
U6230-X-400	OH/UG	CP	Stud	(2) 3/0-500	Lever	6	36¼	34	4	2½	½	¼

Notes

- Side Buss Units: U6228 and U6230.



Please consult serving utility for their requirements prior to ordering or installing, as specifications and approvals vary by utility, and may require local electrical inspector approval. All installations must be installed by a licensed electrician and must comply with all national and local codes, laws and regulations. Milbank reserves the right to make changes in specifications and features shown without notice or obligation.

320 Amps Meter Mains

17

320 Amps | 7 Terminals | Ringless | HD Lever | 2/200 Amps Main Breakers

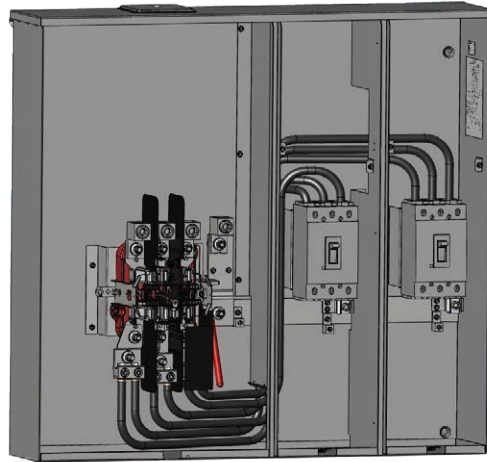

U6056-X-2/200

320 Amps | 7 Terminals | Meter Mains | 3Ø4W | NEC 2020 Compliant

Catalog Number	Service	Hub	Connectors CU/AL	Dimensions			Knockouts			
			Line	D"	W"	H"	1	2	3	4
U6056-X-2/200	OH/UG	C.P.	#4-600 kcmil or (2) #1/0-250	7	36¼	34	4	2½	½	¼

Specifications

- **AIC Rating:** 22K AIC at 240V.

Please consult serving utility for their requirements prior to ordering or installing, as specifications and approvals vary by utility, and may require local electrical inspector approval. All installations must be installed by a licensed electrician and must comply with all national and local codes, laws and regulations. Milbank reserves the right to make changes in specifications and features shown without notice or obligation.



Multi-Position Sockets

100 Amps | 4 Terminals | Ringless



U8212-RL

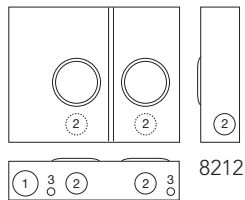

U4252-RXL-K2

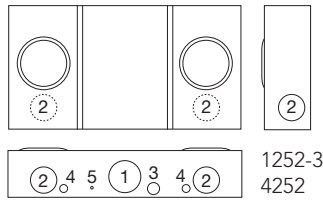

U1252-RRL

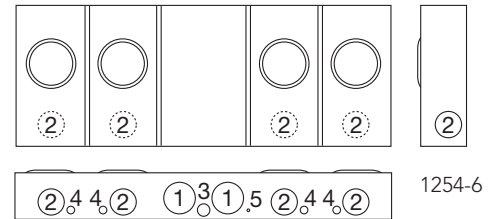

100 Amps per position | 4 Terminals | Ringless | 1Ø3W

Catalog Number	No. of Pos.	Hub	Service	Connectors CU/AL		Dimensions			Knockouts				
				Line	Load	D"	W"	H"	1	2	3	4	5
U8212-RL	2	H.O.	OH/UG	#6-350 kcmil	#6-2/0	4½	20⅝	16	2	2	2	2½	¼, ½
U8213-RL	3	H.O.	OH/UG	#6-350 kcmil	#6-2/0	4½	28½	16	2	2	2	2½	¼, ½
U8214-RL	4	H.O.	OH/UG	#6-350 kcmil	#6-2/0	4½	40⅞	16	2	2	2	2½	¼, ½
U8215-RL	5	H.O.	OH/UG	#6-350 kcmil	#6-2/0	4½	48⅞	16	2	2	2	2½	¼, ½
U8216-XL	6	C.P.	OH/UG	#6-350 kcmil	#6-2/0	4½	57⅞	16	2	2	2	2½	¼, ½

200 Amps per position | 4 Terminals | Ringless | 1Ø3W

Catalog Number	No. of Pos.	Hub	Service	Connectors CU/AL		Dimensions			Knockouts					
				Line	Load	D"	W"	H"	1	2	3	4	5	6
U4252-RXL-K2	2	C.P.	OH/UG	¾"-16 Stud	#6-350 kcmil	5⅞	26½	14	3	2½	—	1¼	¼	—
U1252-REL-K1	2	2½	OH/UG	¾"-16 Stud	#6-350 kcmil	5⅞	26½	14	2½	3	2½	½	¼	½, ¾, 1
U1253-X	3	C.P.	OH/UG	¾"-16 Stud	#6-350 kcmil	5⅞	34⅞	14	2½	3	2½	½	¼	¼, ½, 1
U1254-X	4	C.P.	OH/UG	¾"-16 Stud	#6-350 kcmil	5⅞	42⅞	16	2½	3	2½	½	¼	¼, ½, 1
U1255-X	5	C.P.	OH/UG	¾"-16 Stud	#6-350 kcmil	5⅞	54⅞	16	2½	3	2½	½	¼	¼, ½, 1
U1256-X	6	C.P.	OH/UG	¾"-16 Stud	#6-350 kcmil	5⅞	63⅞	18	2½	3	2½	½	¼	¼, ½, 1

Notes

- **Hub:** For proper hub selection refer to the hub suffix chart on the accessory page. For the **U1255-6** two hub openings are supplied and the extra opening is closed with a closing plate as standard. For the **U8212** a hub opening is supplied at each end and the extra opening is closed with a closing plate as standard.
- **Fifth Terminal:** For field mounted fifth terminal for **U8212-6**, order **5T8K2** (6 o'clock position). For field mounted fifth terminal for **U4252** and **U1252-6**, order catalog number **K5T** (9 o'clock position).
- **Connectors:** Extruded aluminum connectors are tin plated.
- **Bussing:** Bussing is 5/16" x 1" aluminum on the **U1252-1253**, **U4252** and the **U8212-6**. On the **U1254-6** gangs the bussing is ¾" x 1" aluminum.



Please consult serving utility for their requirements prior to ordering or installing, as specifications and approvals vary by utility, and may require local electrical inspector approval. All installations must be installed by a licensed electrician and must comply with all national and local codes, laws and regulations. Milbank reserves the right to make changes in specifications and features shown without notice or obligation.

Multi-Position Meter Main

125-200 Amps | 4 Terminals | Ringless | 240V



U5882-X



U5884-X

125 Amps Per Position

Catalog Number	Amps	Positions	Term	Service	WT (#)
U5902-X	100	2	4	OH/UG	58
U5903-X	100	3	4	OH/UG	88
U5904-X	100	4	4	OH/UG	107
U5905-X	100	5	4	OH/UG	128
U5906-X	100	6	4	OH/UG	146

200 Amps Per Position

Catalog Number	Amps	Positions	Term	Service	WT (#)
U5882-X	200	2	4	OH/UG	58
U5883-X	200	3	4	OH/UG	88
U5884-X	200	4	4	OH/UG	107
U5885-X	200	5	4	OH/UG	128
U5886-X	200	6	4	OH/UG	146

Notes

- **AIC Rating:** All models are rated 22K AIC.
- **Hub:** Units supplied with one (1) closing plate. Order hubs separately, see accessory page.
- **Fifth Terminal:** For field-installed 208Y/120 network service, order **K5T**. Installs in the 9 o'clock position.

Circuit Breaker Chart

Manufacturer	10K Models	22K Models
Siemens	QP, QN	QPH, QNH
Cutler-Hammer	BR, HPQ, QPGF	—
Square D GE (50 Amps Max.)	Homeline THQL, THQL-GF	—

Please consult serving utility for their requirements prior to ordering or installing, as specifications and approvals vary by utility, and may require local electrical inspector approval. All installations must be installed by a licensed electrician and must comply with all national and local codes, laws and regulations. Milbank reserves the right to make changes in specifications and features shown without notice or obligation.



Knockouts				
1	2	3	4	5
3	2½	1	¾	¼

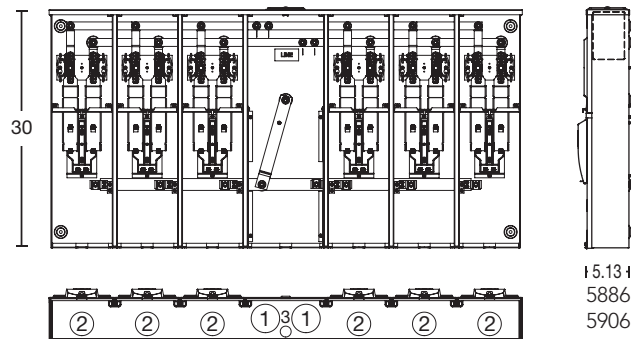
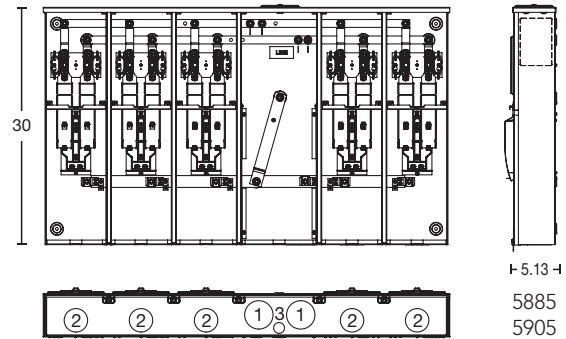
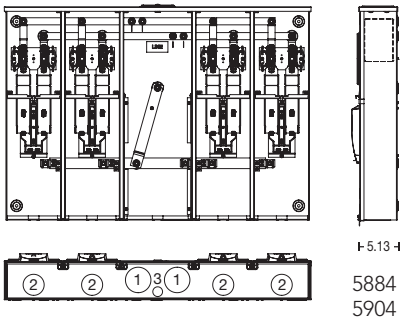
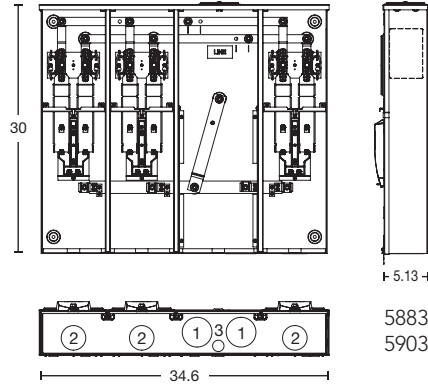
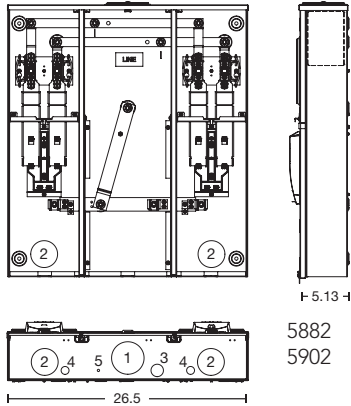

Please consult serving utility for their requirements prior to ordering or installing, as specifications and approvals vary by utility, and may require local electrical inspector approval. All installations must be installed by a licensed electrician and must comply with all national and local codes, laws and regulations. Milbank reserves the right to make changes in specifications and features shown without notice or obligation.

Temp Power

4 Terminals | 240V

21



U4908-O-11GR

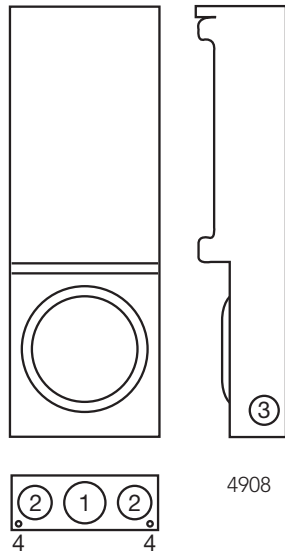

4908



U5101-XL-11GR

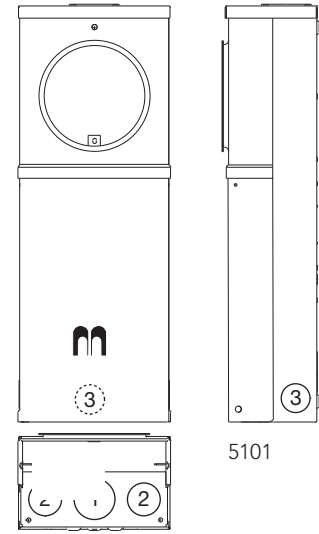

5101

320 Amps Meter Main with Breakers | 3Ø4W | Ringless | 277/480V

Catalog Number	Service	Hub	Connectors CU/AL		Bypass	Dimensions			Knockouts			
			Line	Load		D"	W"	H"	1	2	3	4
U4908-O-11GR	UG	None	#6-2/0	Breaker	None	13 ⁵ / ₁₆	9	25 ⁵ / ₁₆	2	1½	1¼	¼
U5101-XL-11GR	OH	CP	#6-250	Breaker	None	5 ³ / ₁₆	8 ⁷ / ₈	25	2	1½	1¼	—

Specifications

- Available in ringless style (**U4908** series) or ring type (**U4909** series).
- UL-listed 100 Amps, 120/240 Volt – 1Ø Underground. Service Power Outlet. (**U4908-UG** and **U5101-OH**)
- Type 3R welded enclosure for durable outdoor use.
- Hub opening with closure plate. (**U5101**)
- Wire terminations accept copper or aluminum conductors. (**U4908**)
 Service-Line and Neutral: (1) #6-2/0
 Load Ground: (2) 1/0-#14 and (4) #6-#14
 Load Neutral: (2) 1/0-#14 and (4) #6-#14
 Service Ground: #2-#8
- Wire terminations accept copper or aluminum conductors. Loop feed not available. (**U5101**)
 Line: (1) #6-250 kcmil
 Ground: (2) 1/0-#14 and (4) #6-#14
 Neutral: (2) 1/0-#14 and (4) #6-#14
- Four terminal, ringless meter socket with stainless steel locking hasp.

Please consult serving utility for their requirements prior to ordering or installing, as specifications and approvals vary by utility, and may require local electrical inspector approval. All installations must be installed by a licensed electrician and must comply with all national and local codes, laws and regulations. Milbank reserves the right to make changes in specifications and features shown without notice or obligation.



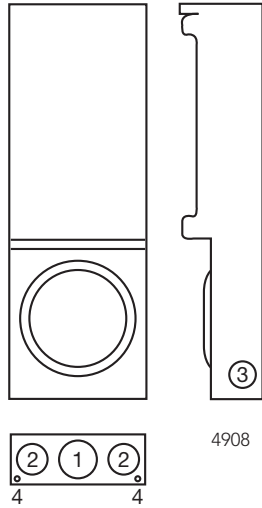

4908

U4908-O-100MB-11GR

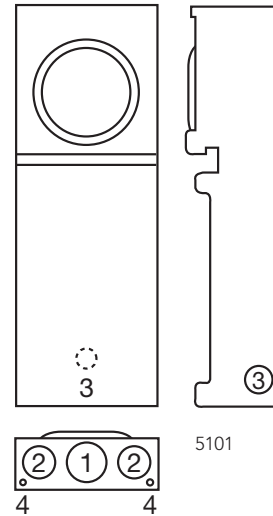

5101

U5101-XL-100MB-11GR

320 Amps Meter Main with Breakers | 3Ø4W | Ringless | 277/480V

Catalog Number	Service	Hub	Connectors CU/AL		Bypass	Dimensions			Knockouts			
			Line	Load		D"	W"	H"	1	2	3	4
U4908-O-100MB-11GR	UG	None	#6-2/0	Breaker	None	13 ⁵ / ₁₆	9	25 ⁵ / ₁₆	2	1 ¹ / ₂	1 ¹ / ₄	1 ¹ / ₄
U5101-XL-100MB-11GR	OH	CP	#6-250	Breaker	None	5 ³ / ₁₆	8 ⁷ / ₈	25	2	1 ¹ / ₂	1 ¹ / ₄	–

Specifications

- Available in ringless style (**U4908** series) or ring type (**U4909** series).
- UL-listed 100 Amps, 120/240 Volt – 1Ø Underground. Service Power Outlet. (**U4908-UG** and **U5101-OH**)
- Type 3R welded enclosure for durable outdoor use.
- Hub opening with closure plate. (**U5101**)
- Wire terminations accept copper or aluminum conductors. (**U4908**)
 Service-Line and Neutral: (1) #6-2/0
 Load Ground: (2) 1/0-#14 and (4) #6-#14
 Load Neutral: (2) 1/0-#14 and (4) #6-#14
 Service Ground: #2-#8
- Wire terminations accept copper or aluminum conductors. Loop feed not available. (**U5101**)
 Line: (1) #6-250 kcmil
 Ground: (2) 1/0-#14 and (4) #6-#14
 Neutral: (2) 1/0-#14 and (4) #6-#14
- Four terminal, ringless meter socket with stainless steel locking hasp.



Please consult serving utility for their requirements prior to ordering or installing, as specifications and approvals vary by utility, and may require local electrical inspector approval. All installations must be installed by a licensed electrician and must comply with all national and local codes, laws and regulations. Milbank reserves the right to make changes in specifications and features shown without notice or obligation.

Surface-mount Power Outlet

23

Millennium Series | Metered and Unmetered | 120/240V



U5000-XL-75

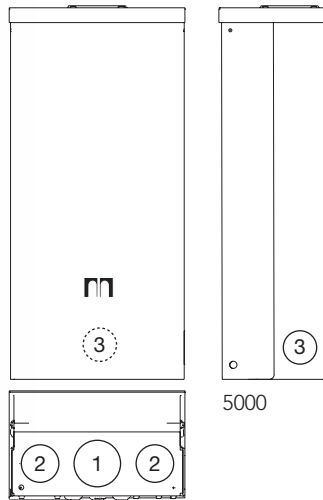

5000

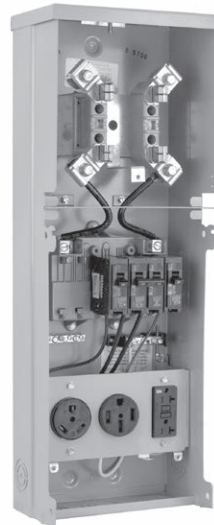

U5100-XL-75

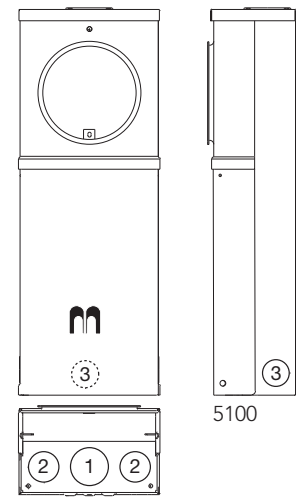

5100

125 Amps | Surface-mount Power Outlets

Catalog Number	Metered/ Unmetered	Receptacle Configuration	Circuit Breaker Configuration	Loop Feed	Connectors - Line	Dimensions			Knockouts		
						D"	W"	H"	1	2	3
U5000-XL	Unmetered	—	—	Yes	(2) #14-2/0	5¼	9⅞	19¼	2	1½	1¼
U5000-XL-41	Unmetered	A	X	Yes	(2) #14-2/0	5¼	9⅞	19¼	2	1½	1¼
U5000-XL-55	Unmetered	B	Y	Yes	(2) #14-2/0	5¼	9⅞	19¼	2	1½	1¼
U5000-XL-75	Unmetered	C	Z	Yes	(2) #14-2/0	5¼	9⅞	19¼	2	1½	1¼
U5100-XL	Metered	—	—	No	#6-250	5¼	9⅞	25	2	1½	1¼
U5100-XL-41	Metered	A	X	No	#6-250	5¼	9⅞	25	2	1½	1¼
U5100-XL-55	Metered	B	Y	No	#6-250	5¼	9⅞	25	2	1½	1¼
U5100-XL-75	Metered	C	Z	No	#6-250	5¼	9⅞	25	2	1½	1¼

Receptacle Configurations

A	B	C
(1) TT30R, (1) 5-20R GFI	(1) 14-50R, (1) 5-20R GFI	(1) 14-50R, (1) TT30R, (1) 5-20R GFI

NOTE
Contact factory for additional configurations not shown here.

Circuit Breaker Configurations

X	Y	Z
(1) 30A, 1P, 120V (1) 20A, 1P, 120V	(1) 50A, 2P, 120/240V (1) 20A, 1P, 120V	(1) 50A, 2P, 120/240V (1) 30A, 1P, 120V (1) 20A, 1P, 120V

Please consult serving utility for their requirements prior to ordering or installing, as specifications and approvals vary by utility, and may require local electrical inspector approval. All installations must be installed by a licensed electrician and must comply with all national and local codes, laws and regulations. Milbank reserves the right to make changes in specifications and features shown without notice or obligation.





U5200-XL-75

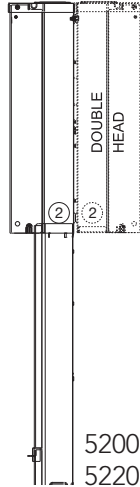
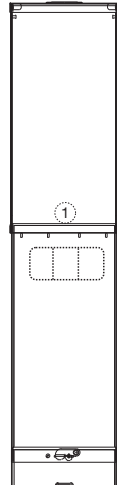

5200
5220



U5300-O-75

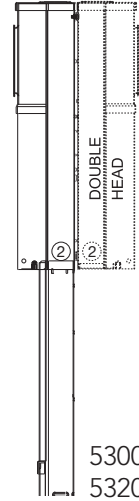
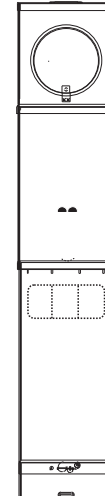

5300
5320

125 Amps | Power Outlet Pedestals | Direct Burial

Catalog Number	Double Head Catalog Number	Metered/Unmetered	Receptacle Configuration	Circuit Breaker Configuration	Dimensions			Knockouts
					D"	W"	H"	
U5200-XL	U5220-XL	Unmetered	—	—	5 ⁵ / ₁₆	9 ⁷ / ₈	64 ¹ / ₂	1 ¹ / ₄
U5200-XL-41	U5220-XL-41	Unmetered	A	X	5 ⁵ / ₁₆	9 ⁷ / ₈	64 ¹ / ₂	1 ¹ / ₄
U5200-XL-55	U5220-XL-55	Unmetered	B	Y	5 ⁵ / ₁₆	9 ⁷ / ₈	64 ¹ / ₂	1 ¹ / ₄
U5200-XL-75	U5220-XL-75	Unmetered	C	Z	5 ⁵ / ₁₆	9 ⁷ / ₈	64 ¹ / ₂	1 ¹ / ₄
U5300-O	U5320-O	Metered	—	—	5 ⁵ / ₁₆	9 ⁷ / ₈	70 ¹ / ₄	1 ¹ / ₄
U5300-O-41	U5320-O-41	Metered	A	X	5 ⁵ / ₁₆	9 ⁷ / ₈	70 ¹ / ₄	1 ¹ / ₄
U5300-O-55	U5320-O-55	Metered	B	Y	5 ⁵ / ₁₆	9 ⁷ / ₈	70 ¹ / ₄	1 ¹ / ₄
U5300-O-75	U5320-O-75	Metered	C	Z	5 ⁵ / ₁₆	9 ⁷ / ₈	70 ¹ / ₄	1 ¹ / ₄

Receptacle Configurations

A	B	C
(1) TT30R, (1) 5-20R GFI	(1) 14-50R, (1) 5-20R GFI	(1) 14-50R, (1) TT30R, (1) 5-20R GFI

NOTE

Contact factory for additional configurations not shown here.

Pad-mount is available. Contact factory for information.

Circuit Breaker Configurations





X	Y	Z
(1) 30A, 1P, 120V (1) 20A, 1P, 120V	(1) 50A, 2P, 120/240V (1) 20A, 1P, 120V	(1) 50A, 2P, 120/240V (1) 30A, 1P, 120V (1) 20A, 1P, 120V

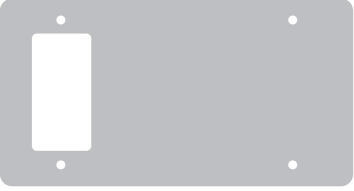

Please consult serving utility for their requirements prior to ordering or installing, as specifications and approvals vary by utility, and may require local electrical inspector approval. All installations must be installed by a licensed electrician and must comply with all national and local codes, laws and regulations. Milbank reserves the right to make changes in specifications and features shown without notice or obligation.

Replacement Receptacle Plates

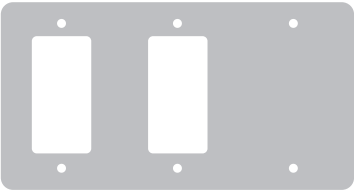
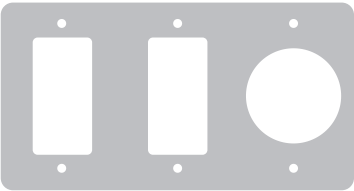
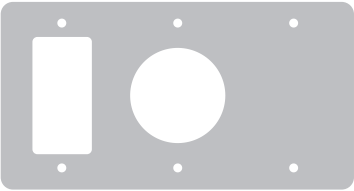
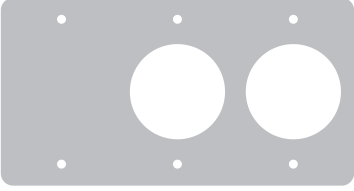
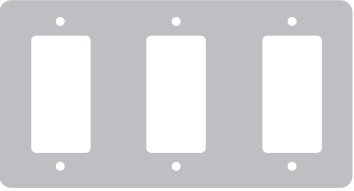
For Millennium Series RV Products

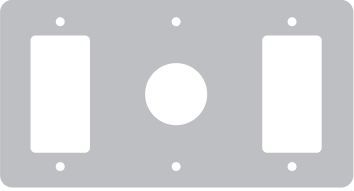
		
K5920-75	K5920-10GR	K5920-54
		
K5920-11GR	K5920-522	K5920-41
		
K5920-58	K5920-111GR	K5920-BLANK
		
K5920-38		

Notes

- For application details, consult factory.

Please consult serving utility for their requirements prior to ordering or installing, as specifications and approvals vary by utility, and may require local electrical inspector approval. All installations must be installed by a licensed electrician and must comply with all national and local codes, laws and regulations. Milbank reserves the right to make changes in specifications and features shown without notice or obligation.

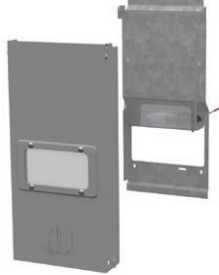

Internal LED Light Kits for **Unmetered** Power Outlets (U5000 and U5200)

Application	Internal light kit for unmetered power outlets	
LED Features	<p>Includes new LED light, lamp shield and opaque hinge cover lens. Factory wired to 20 Amps GFI circuit. May be wired to separate 20 Amps circuit breaker. Order Q120 separately.</p> <p>Cover on unmetered power outlet is 19$\frac{1}{8}$" in height.</p>	
Ordering	<p>Order with -LD suffix (after catalog number) for factory-installed.</p> <p>Order catalog number K6212 for field-installed.</p>	

Internal Florescent Light Kits for **Unmetered** Power Outlets (U5000 and U5200)

Application	Internal light kit for unmetered power outlets	
Fluorescent Features	<p>Includes 5-watt fluorescent lamp socket, ballast, lamp shield and opaque hinge cover lens. Factory wired to 20 Amps GFI circuit. May be wired to separate 20 Amps circuit breaker. Order Q120 separately.</p> <p>Cover on unmetered power outlet is 19$\frac{1}{8}$" in height.</p>	
Ordering	<p>Order with -L suffix (after catalog number) for factory-installed.</p> <p>Order catalog number K5411 for field-installed.</p>	

Photoelectric Light Control Kit

Application	Photoelectric light control kit for K5411 light kits.	
Features	2.5 Amps, 120 volt photo electrical control wired in series with K5411 light kits.	
Ordering	<p>Order with -LPC suffix for factory-installed light and PE control.</p> <p>Order catalog number K5413 for field-installed.</p>	

WARNING!

Always disconnect power prior to installing these devices.



Please consult serving utility for their requirements prior to ordering or installing, as specifications and approvals vary by utility, and may require local electrical inspector approval. All installations must be installed by a licensed electrician and must comply with all national and local codes, laws and regulations. Milbank reserves the right to make changes in specifications and features shown without notice or obligation.

Lighting Accessories

For Millennium Series Products

Internal Light Kits for Metered Power Outlets (U5100 and U5300)

Application	Internal light kit for metered power outlets	
LED Features	Includes new LED light, lamp shield and opaque hinge cover lens. Factory wired to 20 Amps GFI circuit. May be wired to separate 20 Amps circuit breaker. Order Q120 separately. Cover on metered power outlet is 15¼" in height.	
Ordering	Order with -LD suffix (after catalog number) for factory-installed. Order catalog number K6213 for field-installed.	

Internal Florescent Lights Kits for Metered Power Outlets (U5100 and U5300)

Application	Internal light kit for metered power outlets	
Fluorescent Features	Includes 5-watt fluorescent lamp socket, ballast, lamp shield and opaque hinge cover lens. Factory wired to 20 Amps GFI circuit. May be wired to separate 20 Amps circuit breaker. Order Q120 separately. Cover on metered power outlet is 15¼" in height.	
Ordering	Order with -L suffix (after catalog number) for factory-installed. Order catalog number K5412 for field-installed.	

Photoelectric Light Control Kit

Application	Photoelectric light control kit for K5412 light kits.	
Features	2.5 Amps, 120 volt photo electrical control wired in series with K5412 light kits.	
Ordering	Order with -LPC suffix for factory-installed light and PE control. Order catalog number K5413 for field-installed.	

WARNING!

Always disconnect power prior to installing these devices.



Please consult serving utility for their requirements prior to ordering or installing, as specifications and approvals vary by utility, and may require local electrical inspector approval. All installations must be installed by a licensed electrician and must comply with all national and local codes, laws and regulations. Milbank reserves the right to make changes in specifications and features shown without notice or obligation.



Telephone and Cable TV Kit

Application	Mounts to rear of pedestal series U5200 and U5300 . May also be adaptable to a wooden or similar structure.	
Features	<p>Single: 16" galvanized raceway, (1) RJ11 telephone jack and (1) Type F coaxial CATV jack.</p> <p>Dual: 16" galvanized raceway, (2) RJ11 telephone jacks and (1) Type F coaxial CATV jack.</p> <p>Includes mounting hardware and instructions.</p>	
Ordering	Single line telephone and cable TV kit order K4709-02 .	
Note	Confirm acceptability with Cable TV and Telephone provider before ordering or installing these devices.	

K4709-02-3R

K4709-02

Water Shroud with Hardware

Application	Used to cover water pipe and provide means to mount hose bib to rear of pedestal.	
Features	<p>Includes mounting hardware and instructions.</p> <p>Matches K4709 kits when mounted side-by-side.</p>	
Ordering	Order catalog number K4709-WS .	

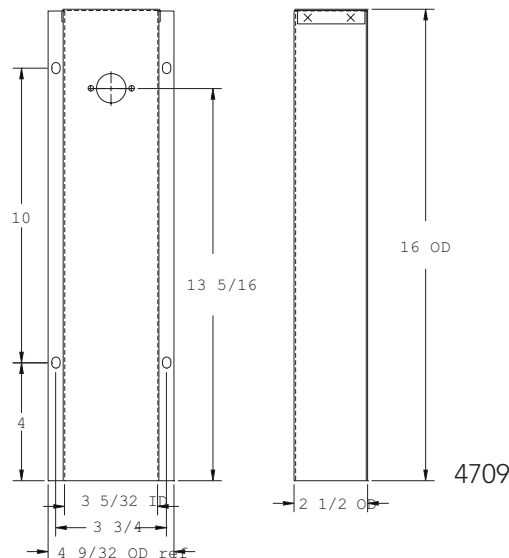

Please consult serving utility for their requirements prior to ordering or installing, as specifications and approvals vary by utility, and may require local electrical inspector approval. All installations must be installed by a licensed electrician and must comply with all national and local codes, laws and regulations. Milbank reserves the right to make changes in specifications and features shown without notice or obligation.

Pedestal Mounting Accessories

For Millennium Series RV Products

Field-Installed Pad-mount Kit

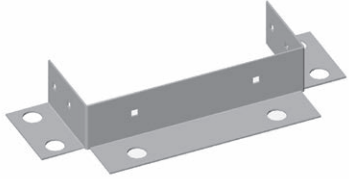
Application	Field-installed pad-mount kit with (6) $\frac{3}{4}$ " mounting holes.	
Features	Includes $\frac{1}{4}$ -20 stainless steel hardware to attach pad-mount base to post. Anchor bolt kit sold separately (order catalog number K5421).	
Ordering	Order catalog number K5410 .	

Stabilizer Foot with Hardware

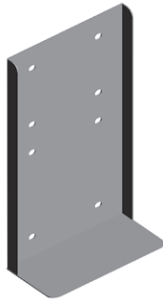
Application	Stabilizes direct burial type posts in unstable soil conditions.	
Features	Includes $\frac{1}{4}$ -20 hardware to attach to U5200 and U5300 pedestals.	
Ordering	Order catalog number K5415 .	

Anchor Bolt Kit

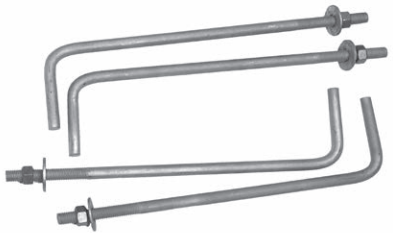
Application	Concrete anchor bolt kit designed to attach pad-mount base to concrete.	
Features	(4) sets of zinc-plated $\frac{5}{8}$ -11 x 10" bolt with 2" toe. Includes nut and flat washer.	
Ordering	Order catalog number K5421 .	

Please consult serving utility for their requirements prior to ordering or installing, as specifications and approvals vary by utility, and may require local electrical inspector approval. All installations must be installed by a licensed electrician and must comply with all national and local codes, laws and regulations. Milbank reserves the right to make changes in specifications and features shown without notice or obligation.







Field-Installed Meter Kits

Application	Field-installed meter kit for U5000 and U5200 power outlets.	
Features	100 Amps cast meter socket, CL200 E-Z Read Meter, sealing ring, security seal, 1" Milbank hub, nipple and mounting screws. See CL200 for Watthour meter specification.	
Ordering	Order catalog number K4800-01 .	

E-Z Read Watthour Meter

Application	200 Amps E-Z read watthour meter designed to be field-installed on the U5100 and U5300 metered power outlets.	
Features	200 Amps form 2S 120/240 volt. Numeric readout in full kilowatt increments. No "tenths" dial. Remanufactured to 1% accuracy.	
Ordering	Order catalog number CL200 or CL200D	

Single Receptacle Only Power Outlet

Application	Overhead/underground power outlet receptacle, suitable for RV, temporary service, campground, marina and boatyard equipment.			 <p>Note: These receptacles are all weather-resistant.</p>
Features	Type 3R, 120/240 volt single phase. Lockable cover.			
Ordering	Order catalog number from chart below.			
Receptacle Options	 P-10GWR 20A 5-20GR 120V GFI	 P-13WR 30A TT-30R 120V	 P-54WR 50A 14-50R 120/240V	











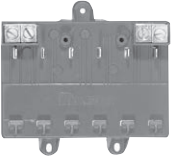

Please consult serving utility for their requirements prior to ordering or installing, as specifications and approvals vary by utility, and may require local electrical inspector approval. All installations must be installed by a licensed electrician and must comply with all national and local codes, laws and regulations. Milbank reserves the right to make changes in specifications and features shown without notice or obligation.

Replacement Parts and Accessories

31

For Millennium Series RV Products

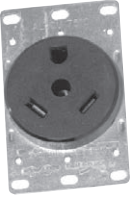
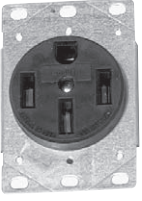
			
<p>Q120 20 Amps, one-pole circuit breaker</p>	<p>708784-MO 20 Amps, one-pole GFI circuit breaker</p>	<p>Q130 30 Amps, one-pole circuit breaker</p>	<p>Q250 50 Amps, 2 pole circuit breaker</p>
			
<p>Z918466-AC Lug landing base</p>	<p>Z917602-AC Circuit breaker base (6-circuit)</p>	<p>Z915141-AC Left or right meter block assembly</p>	
			
<p>Z918449-AC (19" unmetered) Z918447-AC (15" metered) Hinge cover</p>	<p>Z818052-SC (19" unmetered) Z818480-SC (15" metered) Deadfront</p>	<p>MR-2 Snap action sealing ring</p>	
			
<p>Z708080-MO 20 Amps GFI receptacle NEMA 5-20GR</p>	<p>Z701776-MO 30 Amps receptacle NEMA TT-30</p>	<p>Z708767-MO 50 Amps receptacle NEMA 14-50R</p>	

Please consult serving utility for their requirements prior to ordering or installing, as specifications and approvals vary by utility, and may require local electrical inspector approval. All installations must be installed by a licensed electrician and must comply with all national and local codes, laws and regulations. Milbank reserves the right to make changes in specifications and features shown without notice or obligation.



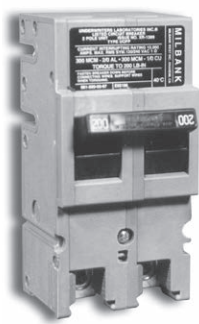

UQFP
UQFPH



UQFP-M
UQFPH-M



UQFB-X1



UQFBH

200 Amps Frame | Plug-In | 10,000 AIC and 22,000 AIC | Two-Pole - Common Trip

Amps	10K AIC Plug-In	22K AIC Plug-In	10K AIC Plug-In	22K AIC Plug-In	Wire Range	
					CU	AL
100	UQFP-100	UQFPH-100	UQFP-M-100	UQFPH-M-100	#3-#1	#1-1/0
125	UQFP-125	UQFPH-125	UQFP-M-125	UQFPH-M-125	#3-#1	#1-1/0
150	UQFP-150	UQFPH-150	UQFP-M-150	UQFPH-M-150	1/0-300	2/0-300
175	UQFP-175	UQFPH-175	UQFP-M-175	UQFPH-M-175	1/0-300	2/0-300
200	UQFP-200	UQFPH-200	UQFP-M-200	UQFPH-M-200	1/0-300	2/0-300

200 Amps Frame | Bolt-On | 10,000 AIC and 22,000 AIC | Two-Pole - Common Trip

Amps	10K AIC Bolt-On	22K AIC Bolt-On	10K AIC Bolt-On	22K AIC Bolt-On	Wire Range	
					CU	AL
100	UQFB-100	UQFBH-100	UQFB-100-X1	UQFBH-M-100	#3-#1	#1-1/0
125	UQFB-125	UQFBH-125	UQFB-125-X1	UQFBH-M-125	#3-#1	#1-1/0
150	UQFB-150	UQFBH-150	UQFB-150-X1	UQFBH-M-150	1/0-300	2/0-300
175	UQFB-175	UQFBH-175	UQFB-175-X1	UQFBH-M-175	1/0-300	2/0-300
200	UQFB-200	UQFBH-200	UQFB-200-X1	UQFBH-M-200	1/0-300	2/0-300

Notes

- **UL-listed:** For use with 60°C or 75°C wire.
- **UQFP:** For parallel main circuit breaker applications.
- **UQFP-M:** For series main circuit breaker applications Split load tab features allow for feed-through capability.
- **UQFB:** (2) 1/0-300 lugs provided on load and line side (cable-in, cable-out).
- **UQFB3:** Three-pole available. Consult factory.
- **UQFB-X:** (2) 1/0-300 lugs provided on load side and (2) line bar bus connections on line side.
- **UQFB-M:** For series main circuit breaker applications. Split load tab features allow for feed-through capability.



Please consult serving utility for their requirements prior to ordering or installing, as specifications and approvals vary by utility, and may require local electrical inspector approval. All installations must be installed by a licensed electrician and must comply with all national and local codes, laws and regulations. Milbank reserves the right to make changes in specifications and features shown without notice or obligation.

Circuit Breakers

QP (small frame) and QN (large frame) | 120/240V

15–125 Amps Breaker
Plug-In Type | 1" Per Pole

Amps	Poles	10K AIC Plug-In	22K AIC Plug-In
15	Single	Q115	Q115H
15	Double	Q215	Q215H
20	Single	Q120	Q120H
20	Double	Q220	Q220H
25	Single	Q125	Q125H
25	Double	Q225	Q225H
30	Single	Q130	Q130H
30	Double	Q230	Q230H
35	Single	Q135	Q135H
35	Double	Q235	Q235H
40	Single	Q140	Q140H
40	Double	Q240	Q240H
50	Single	Q150	Q150H
50	Double	Q250	Q250H
60	Single	Q160	Q160H
60	Double	Q260	Q260H
70	Single	Q170	Q170H
70	Double	Q270	Q270H
80	Double	Q280	Q280H
90	Double	Q290	Q290H
100	Double	Q2100	Q2100H
125	Double	Q2125	Q2125H



QN2200H



QN2200RH



WBJ2200



Q250

200 Amps Frame | Plug-In | 10,000 AIC and 22,000 AIC | Two-Pole, Common Trip

Amps	10K AIC Plug-In	22K AIC Plug-In	Handle Location	Wire Range	
				CU	AL
150	QN2150	QN2150H	Left facing	#4-300	#4-300
200	QN2200	QN2200H	Left facing	#4-300	#4-300
150	QN2150R	QN2150RH	Right facing	#4-300	#4-300
200	QN2200R	QN2200RH	Right facing	#4-300	#4-300
150	WBJ2150	—	Centered	#2-300	#2-300
200	WBJ2200	—	Centered	#2-300	#2-300

Notes

- Load connectors supplied with breakers.
- UL-listed for use with 60°C or 75°C wire.
- Wire sizes shown are lug capacity. Consult NEC Article #310 for specific wire sizes.

Please consult serving utility for their requirements prior to ordering or installing, as specifications and approvals vary by utility, and may require local electrical inspector approval. All installations must be installed by a licensed electrician and must comply with all national and local codes, laws and regulations. Milbank reserves the right to make changes in specifications and features shown without notice or obligation.



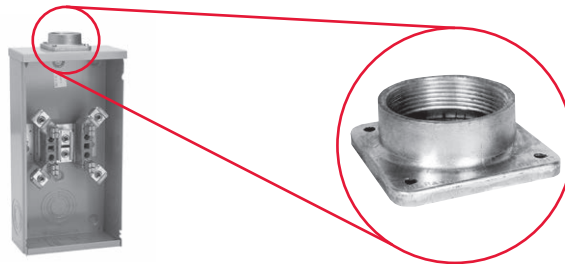
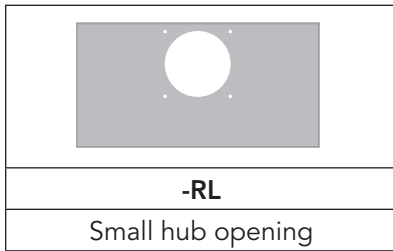

-WL A7514	-YL A7515	-ZL A7516	-DL A7517	-EL A7518	-XL A7551
1" hub	1¼" hub	1½" hub	2" hub	2½" hub	Small closing plate

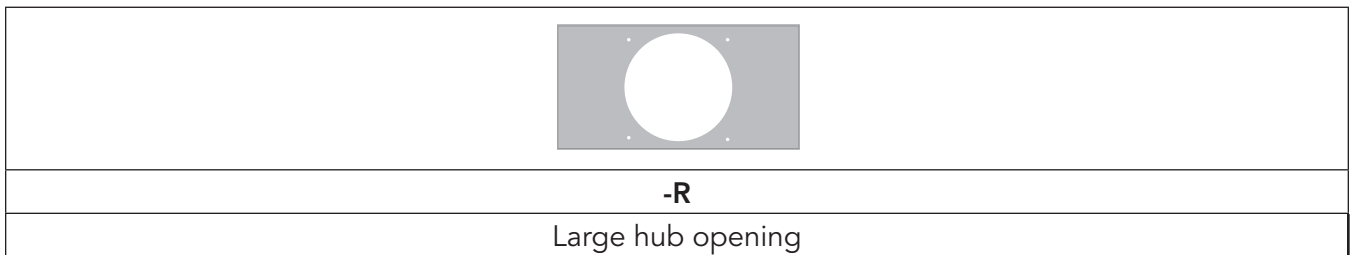

-F A8110	-G A8111	-H A8112	-X A9064	-RRL S8324
3" hub	3½" hub	4" hub	Large closing plate	Large hub opening adapted to small hub opening

Notes



- **Suffix:** Add to catalog number for factory installation of hub.
- **Packaging:** Individually packed units for field installation.
- **Abbreviations:** H.O. (hub opening), C.P. (closing plate).
- Hub Mast rated.



Please consult serving utility for their requirements prior to ordering or installing, as specifications and approvals vary by utility, and may require local electrical inspector approval. All installations must be installed by a licensed electrician and must comply with all national and local codes, laws and regulations. Milbank reserves the right to make changes in specifications and features shown without notice or obligation.

Connector Kits, Closing Kits and Generator Interlock

Connector Kits — For Use with 3/8"-16 Stud Type Units Only

					
Single			Twin		
Suffix	Part #	(3 per set) - 1Ø	Suffix	Part #	(3 per set) - 1Ø
K1	K1539	6-350	K2	K1350	6-350
K3	K1540	4-600 or (2) 1/0-250*	K2L	K1350L	6-350 (non rotating)
K3L	K1540L	4-600 or (2) 1/0-250* (non rotating)	K4	K1541	4-600
Suffix	Part #	(4 per set) - 3Ø	Suffix	Part #	(4 per set) - 3Ø
K5	K3082	6-350	K6	K3442	6-350
K7	K3441	4-600 or (2) 1/0-250*	K8	K3083	4-600

*For (2) 1/0-250, conductors must be of same size.

Bypass Link





K8180 (sold in pairs)

Note

Consult factory for proper connector kits for studded meter sockets.

Closing Covers

	
Meter Closing Plate (Ring Type / Ringless)	Metal Closing Plate (For Ringless Sockets)
6003 - Gray Plastic	CP-21
6116 - Clear Plastic	
6002 - Clear Plastic	

Note

Consult factory for kits that are available.

Disconnect Sleeve



M5-144

Do not use with lever bypass sockets

Isolated Neutral Kit



K1047

Note



Consult factory for correct isolated neutral.

Please consult serving utility for their requirements prior to ordering or installing, as specifications and approvals vary by utility, and may require local electrical inspector approval. All installations must be installed by a licensed electrician and must comply with all national and local codes, laws and regulations. Milbank reserves the right to make changes in specifications and features shown without notice or obligation.

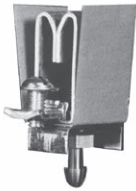
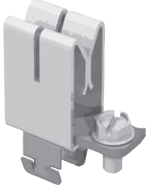

Fifth Terminal, Tap Connectors and Block Assemblies

Fifth Terminal

		
5T8K2 - 100-200 Amps "Plug-In"	K5T - 200 Amps (Block with Square Hole)	K3865 - Heavy Duty Jaw Clamping (K3866 without Neutral Wire)

Tap Connectors (3 per set)

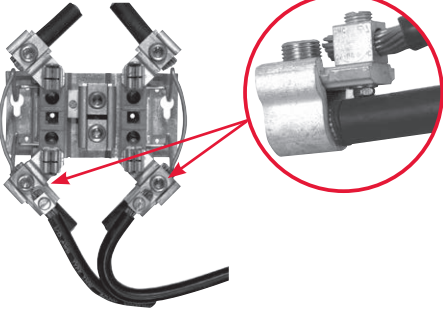
	Replaces the load or line side slide-in nut assembly on Milbank 200 Amps sockets. Allows for a 100 Amps tap location in addition to the #6-350 kcmil load-side connector. K5022 includes safety barrier extensions for applications over 300 VAC. Three lugs per kit.
K4977-INT - Internal Hex	
K4977-EXT - External Hex	
K5022-INT - Internal Hex (set of 4 w/ barrier)	

Triplex Ground

K1190 (For factory-installed triplex ground, add suffix -TG to catalog number)

100 Amps Blocks *(single sockets only)*

BL7499 - Block Assembly (w/ horn bypass)

200 Amps Blocks *(single sockets only)*

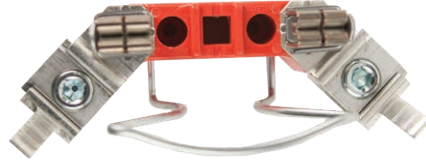
K4529 - Internal Hex Block Assembly (w/ horn bypass)



Please consult serving utility for their requirements prior to ordering or installing, as specifications and approvals vary by utility, and may require local electrical inspector approval. All installations must be installed by a licensed electrician and must comply with all national and local codes, laws and regulations. Milbank reserves the right to make changes in specifications and features shown without notice or obligation.

Enclosed Controls

Attractive | Easy-to-Install | Secure | Cost-Effective

Milbank enclosed controls are an alternative to unsightly and inefficient strut and backboard structures. Enclosed controls are an attractive, secure, easy-to-install and cost-effective solution for underground remote site power distribution. Cabinets are weather-resistant enclosures that can be crafted to suit any environment with various mounting options. Each individual unit features a utility pull section with an optional meter socket and a separate customer section with distribution and control equipment.



Strut and Backboard



Commercial Pedestal

UL-Listed as Industrial Control Equipment (File E113855)

Standard Features

- NEMA Type 3R rain-resistant, vandal-resistant cabinet of polyurethane powder coated steel (aluminum or stainless steel also available).
- UL-listed as enclosed industrial control equipment (UL508A).
- Isolated lockable and sealable utility metering and lug landing sections.
- Lockable customer section for distribution and control equipment with internal deadfront.
- Print pocket inside customer section door contains wiring schematics and installation instructions.
- Load centers are UL-listed for use with various manufacturers' circuit breakers.
- All stainless steel external hardware (screws, bolts, hinges, handles, hasps and sealing screws).

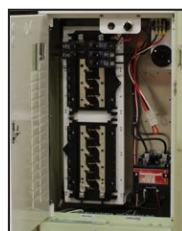
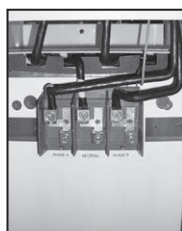

Please consult serving utility for their requirements prior to ordering or installing, as specifications and approvals vary by utility, and may require local electrical inspector approval. All installations must be installed by a licensed electrician and must comply with all national and local codes, laws and regulations. Milbank reserves the right to make changes in specifications and features shown without notice or obligation.



Attractive | Easy-to-Install | Secure | Cost-Effective



Applications

These units are ideal for controlling and metering:

- Traffic signals and street lighting for municipalities.
- Power distribution for electric vehicle charging stations.
- Communication equipment such as cell towers and telephone vaults.
- Event power for fairgrounds, outdoor markets, portable offices, holiday lights, etc.
- Outdoor lighting for athletic fields, tennis and basketball courts, parking lots, landscaping and subdivision entrances.

Available Factory-Installed Options

- Meter sockets: ring type or ringless, up to 400 Amps
- Main and branch breakers or T fuses
- Distribution: copper load centers and panelboards
- Clocks, timers and relays
- Photoelectric cells and controls
- Various power receptacles: pin and sleeve, twist lock or straight blade
- Contactors: lighting, definite purpose, motor starters
- Surge protection and lightning arresters
- Generator inlets with interlocked breakers
- Push button controls
- Thermostat controls, fans and heating strips
- Power blocks and Terminals blocks
- Steel, aluminum and plywood backboards
- Transformers
- Interlock devices for circuit breakers

Options

- Available in steel, aluminum (raw painted or anodized) or stainless steel construction with powder coated finish available in eight standard colors or special-ordered RAL colors.
- Available for applications up to 400 Amps, 120V, 208V, 240V, 277V, 480V - 1Ø or 3Ø.

Accessories

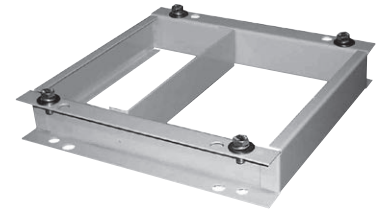

Pad-mount bases available for all pedestal sizes, inquire with your representative for details.

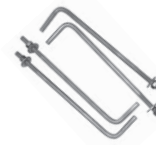

CP-ABK5/8
Anchor bolt kit
(includes four 5/8 - 13 x 18" anchor bolts)



105J
Fifth Terminals kit for use with ring type meter sockets



K3865
Fifth Terminals kit for use with ringless meter sockets



CP-TC7D
7-day time clock kit
CP-TC24H
24-hour time clock kit
CP-TCWIRE
Male 4-pin connector and wiring harness for use with time clocks other than above

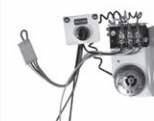

CP-PE-HOA-3POS
HOA switch for field installation



Please consult serving utility for their requirements prior to ordering or installing, as specifications and approvals vary by utility, and may require local electrical inspector approval. All installations must be installed by a licensed electrician and must comply with all national and local codes, laws and regulations. Milbank reserves the right to make changes in specifications and features shown without notice or obligation.

Enclosed Controls

Main Load Center Commercial Pedestals | 1Ø3-wire 120/240V or 208Y/120V

Application: Remote site service for multiple loads

Milbank Main Load Center Commercial Pedestals are designed to handle the vast majority of all requirements in a standard, stocked configuration.

- All units feature a load center with a plug-on, back-fed main breaker.
- Standard units are equipped with with a 16 circuit load center in the 100 Amps or 24 circuit load center in 200 Amps models.
- Sub-feed lugs to allow feeding an external panel.

If your application requires turning loads on based on “dusk-to-dawn” requirements, be sure to see the Milbank Switched Load Center Commercial Pedestal products on the following page.

Features

These units include everything required for remote site service:

- Expandable: load centers allow for future expansion without costly modifications.
- All units feature a 200 Amps meter socket with optional field-installable fifth Terminals kit available.
- 22K Amps interrupting capacity (AIC) standard.
- Optional mounting base can be embedded in concrete for fast, easy installation.
- Separate sealable and lockable utility termination section.
- Separate sealable and lockable metering section.
- Separate sealable and lockable customer section with a load center for “always on” loads that include a main circuit breaker, 20 (125 or 200 Amps model) or 14 (100 Amps model) blank breaker spaces and a circuit directory to document configuration.



Please consult serving utility for their requirements prior to ordering or installing, as specifications and approvals vary by utility, and may require local electrical inspector approval. All installations must be installed by a licensed electrician and must comply with all national and local codes, laws and regulations. Milbank reserves the right to make changes in specifications and features shown without notice or obligation.



Switched Load Center Commercial Pedestals

1Ø3-wire 120/240V or 208Y/120V

Designed not only to provide power for various loads, but also to switch specific loads on and off under certain conditions. A photoelectric cell is used for these controlled loads, and an optional time clock is also available.

Features

These units include everything required for remote site service:

- Expandable: load centers allow for future expansion without costly modifications.
- All units feature a 200 Amps meter socket with optional field-installable fifth Terminals kit available.
- 22K Amps interrupting capacity (AIC) standard.
- Optional mounting base can be embedded in concrete for fast, easy installation.
- Separate sealable and lockable utility termination section.
- Separate sealable and lockable metering section.
- Separate sealable and lockable customer section with a control circuit including PE receptacle, Lexan® window, glare shield, Hand-Off-Auto (HOA) switch, contractor controlling a 16-circuit load center for controlled loads, a pre-mounted DIN rail and pre-wired connector to add an optional "plug-and-play" time clock kit for PE on and TC off operation and a circuit directory to document configuration.
- A load center for "always on" loads that includes a main circuit breaker, a control power circuit breaker, a switched load center main breaker, nine (125 or 200 Amps model) or 11 (100 Amps model) blank breaker spaces and a circuit directory to document configuration.

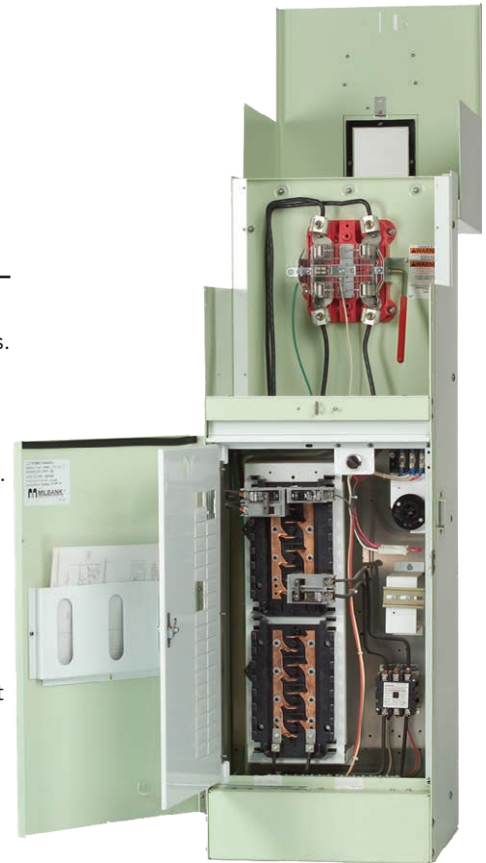

Ringless Lever Bypass shown

Applications



Traffic Signals



Parking Lots



Highways



Athletic Field Lighting



Please consult serving utility for their requirements prior to ordering or installing, as specifications and approvals vary by utility, and may require local electrical inspector approval. All installations must be installed by a licensed electrician and must comply with all national and local codes, laws and regulations. Milbank reserves the right to make changes in specifications and features shown without notice or obligation.

Enclosed Controls

400 Amps Commercial Pedestals



Designed to provide a weather- and vandal-resistant metered enclosure for various loads and distribution. Each pedestal has been designed to handle a wide range of applications using standard, stocked configurations including:

- Choice of a single main breaker or twin service disconnect breakers gives flexibility to the pedestal design.
- Optional distribution with feed-through lugs below the service disconnect breakers allows the pedestal to handle numerous applications.
- Typical applications include remote homes where the metering is best located at the curb side or other remote area. The pedestal can also provide power to a secondary residence, on-site business, workshop, irrigation, lighting, security or other secondary load.

Features

These units include everything required for remote service:

- Main circuit breaker or dual service disconnects.
- Expandable: load center units that allow for future expansion without costly modifications.
- Optional mounting base can be embedded in concrete for fast, easy installation.
- Separate sealable and lockable utility termination section with lug termination.
- Separate sealable and lockable metering section.
- Separate sealable and lockable customer section with a circuit directory and a print pocket to hold all documentation.
- Meter socket options include Ring-Type with bypass studs, ringless with heavy duty lever bypass, or K-type bolt-on.

Applications



Commercial Job Sites



Remote Site for Residential and Commercial Job Sites

Please consult serving utility for their requirements prior to ordering or installing, as specifications and approvals vary by utility, and may require local electrical inspector approval. All installations must be installed by a licensed electrician and must comply with all national and local codes, laws and regulations. Milbank reserves the right to make changes in specifications and features shown without notice or obligation.



Enclosed Controls

Battery Backup Commercial Pedestals



This product is specifically designed to provide battery backup power to a variety of loads and to conditionally switch specific loads on and off. It can use a photoelectric cell or time clock to control lighting circuits. Battery backup pedestals have options for both metered and unmetered power distribution. These pedestals are highly versatile and can handle the vast majority of today's backup power requirements. Its 19" rack design allows for easy adjustment of shelves to accommodate batteries, DC to AC inverters, transfer switches and other related equipment.

Features

- Works with 100 through 320 Amps meter sockets with the option of either a ring type socket (conforms to EUSERC 308) with or without test/bypass blocks or a heavy duty ringless socket with lever bypass.
- Separate sealable utility termination compartment.
- An isolated separate customer section with service disconnects, power distribution options and power control.
- 19" wide rack in customer compartment for easy layout of equipment.
- Includes trays to accommodate required batteries.
- Thermostat with cooling fan.
- Filtered louvers for heat rise flow through ventilation.
- Three point door latch (key or padlockable).

Note

- May require customization based on regional requirements.

Applications



Camera and Security Locations

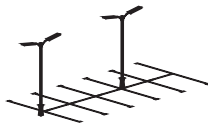

Parking Lots



Traffic Signals



Communications Power Distribution

Options

- | | | |
|--|--|---|
| <ul style="list-style-type: none"> • Manual bypass switch • Transfer switch for generator power backup • Generator inlet receptacles 30 Amps through 200 Amps • Pad-lockable provision for receptacles | <ul style="list-style-type: none"> • Police access door • Metered load center distribution • Unmetered load center distribution • Photo electric controls (for street lighting) • Time clocks • HOA switches | <ul style="list-style-type: none"> • Contactors • GFCI duplex receptacles • Thermostat for heating control • Heating pads or elements • Roll out shelves for batteries • Surge arresters and lighting arresters |
|--|--|---|



Please consult serving utility for their requirements prior to ordering or installing, as specifications and approvals vary by utility, and may require local electrical inspector approval. All installations must be installed by a licensed electrician and must comply with all national and local codes, laws and regulations. Milbank reserves the right to make changes in specifications and features shown without notice or obligation.



Power transfer commercial pedestals provide metered or unmetered AC power, distribution, surge suppression, mechanical interlock and standby generator receptacles — in one compact pedestal.

Features

- 120/240V 1Ø3W through 277/480V 3Ø4W ratings
- Metered or unmetered units
- Choice of EUSERC ring type or ringless meter sockets
- 60 Amps through 400 Amps ratings
- Pad-lockable, isolated utility compartments
- 20 Amps GFCI convenience receptacle
- Lockable recessed generator receptacle door
- Utility and generator indicator light options
- All stainless steel hardware
- Galvanized steel, aluminum or stainless steel cabinet options
- Custom designs available

Note

- May require customization based on regional requirements.

Applications



Traffic Signals



Pump and Lift Stations



Communications Power Distribution

Please consult serving utility for their requirements prior to ordering or installing, as specifications and approvals vary by utility, and may require local electrical inspector approval. All installations must be installed by a licensed electrician and must comply with all national and local codes, laws and regulations. Milbank reserves the right to make changes in specifications and features shown without notice or obligation.



Enclosed Controls

CT Metered Commercial Pedestals



Designed to be used where a smaller service package would be a better choice over larger switchgear equipment. These pedestals have amperage ratings of 400 to 800 Amps at voltages up through 480V three phase.

Features

- Available configurations up to 800 Amps.
- All utility equipment is isolated in separate padlockable and sealable compartments.
- Separate customer compartment designed to hold distribution and control equipment.
- Deadfront customer construction for enhanced safety measures.
- A mounting base option for various applications.
- Optional construction in steel, aluminum and stainless steel.

Note

- May require customization based on regional requirements.

Applications



Commercial and
Industrial Control
Systems



Pump and Lift
Stations



Water Treatment
Plants

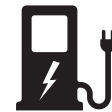

Electric Vehicle
Charging Stations



Please consult serving utility for their requirements prior to ordering or installing, as specifications and approvals vary by utility, and may require local electrical inspector approval. All installations must be installed by a licensed electrician and must comply with all national and local codes, laws and regulations. Milbank reserves the right to make changes in specifications and features shown without notice or obligation.

Enclosed Controls

Slimline Commercial Pedestals



Provides a sleeker, smaller footprint with wireway access on the side of the unit, rather than the back. This allows maximum flexibility to install the pedestal anywhere physical space is at a premium.

Providing unmetered AC power, distribution, surge suppression, mechanical interlock and standby generator receptacle — all in a neat, compact pedestal.

Features

- Available for 100 or 200 Amps.
- Vandal-resistant, secure and attractive design.
- Customer compartment with distribution and control equipment with swing deadfront door, secured with both a hasp/latch and draw latch outer door.
- Utility metering compartment protected with a hinged hood, increasing resistance to meter vandalism.
- Slim design creates a smaller footprint.
- Wireway located on left side of pedestal for utility incoming wire, allowing pedestal to be mounted with back as close as 14" to walls or structures.
- Available in 12" and 20" widths and 50" and 63" (metered) and 43" (unmetered) heights. Includes a print pocket for plans and drawings.
- Voltage range is between 120V and 480V.
- Compatible with both ringless and ring type meter sockets, 4–7 terminals.
- Available in a wide array of colors, including but not limited to all ANSI powder coated paint colors upon request.
- Pedestal mounting base option saves time and labor to install on a cement pad—no anchor bolts required.
- Powder coated G90 galvanized steel or aluminum; raw, anodized or powder coated, as well as stainless steel exterior options.



With no need to coordinate, buy or wait for concrete, **direct bury pedestals** offer many advantages and can cut installation time down to less than an hour. Traditional direct bury pedestals can be awkward to transport and can only be used in a direct bury application. Milbank's modular design offers flexibility and convenience for distributors and contractors alike.



Notes

- May require customization based on regional requirements.
- Direct bury pedestals are only available for 12" pedestals. Constructed with 14-gauge steel.

Please consult serving utility for their requirements prior to ordering or installing, as specifications and approvals vary by utility, and may require local electrical inspector approval. All installations must be installed by a licensed electrician and must comply with all national and local codes, laws and regulations. Milbank reserves the right to make changes in specifications and features shown without notice or obligation.



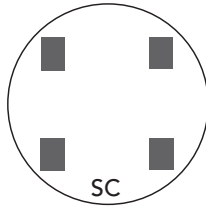

2 and 3-WIRE FORMS
1S & 2S

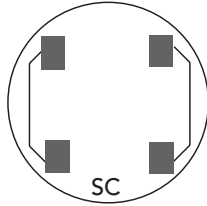

2 and 3-WIRE FORMS
1S & 2S with bypass

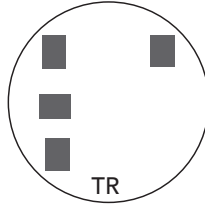

2-WIRE FORM 3S
5th Term. 9 o'clock

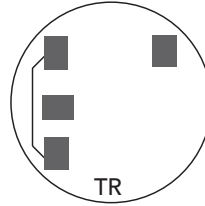

2-WIRE FORM 3S
with bypass

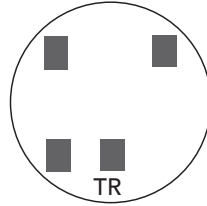

2-WIRE FORM 3S
5th Term. 6 o'clock

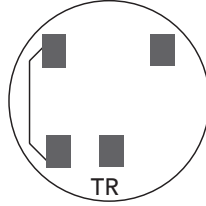

2-WIRE FORMS 3S
with bypass

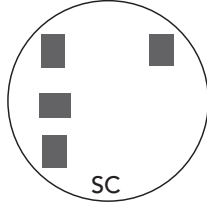

2 ELEMENT 3-WIRE
NETWORK FORM 12S
5th Term. 9 o'clock

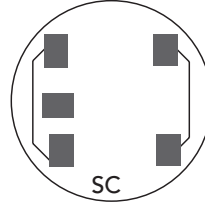

2 ELEMENT 3-WIRE
NETWORK FORM 12S
5th Term. 9 o'clock

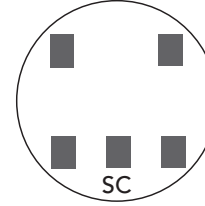

2 ELEMENT 3-WIRE
NETWORK FORM 12S
5th Term. 6 o'clock

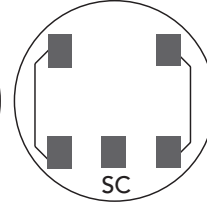

2 ELEMENT 3-WIRE
NETWORK FORM 12S
with bypass
5th Term. 6 o'clock

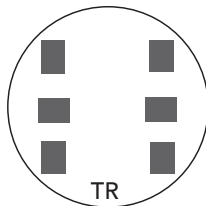

3-WIRE FORMS 4S

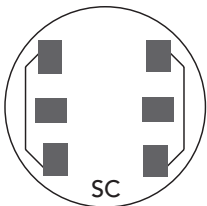

3-WIRE FORM 4S
with bypass

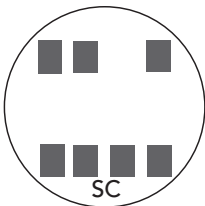

2 or 3 ELEMENT
3Ø4W Y or Δ
Y FORM 14S

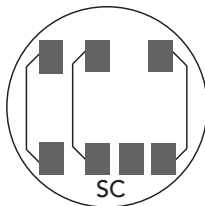

2 or 3 ELEMENT
3Ø4W Y or Δ
with bypass

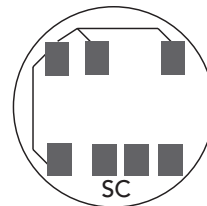

2 ELEMENT 3Ø4W Y or
Δ Y FORM 7S Δ FORM 24S
with bypass

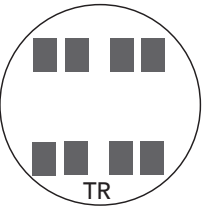

2 ELEMENT
2Ø3W, 2Ø4W, 3Ø3W
FORM 5S

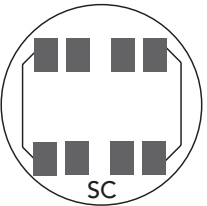

2 ELEMENT
2Ø3W, 2Ø4W, 3Ø3W
FORM 5S with bypass

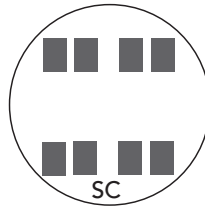

2 ELEMENT
2Ø3W, 2Ø4W, 3Ø3W
FORM 13S

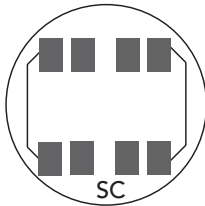

2 or 3 ELEMENT
2Ø3W, 2Ø4W, 3Ø3W
FORM 13S with bypass

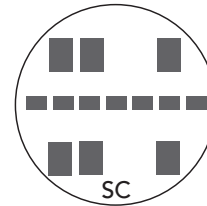

2 or 3 ELEMENT 3Ø4W
Y or Δ Y FORM 9S
Δ FORM 8S

TR= Transformer Rated
SC= Self-Contained

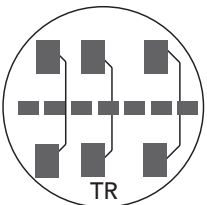

2 or 3 ELEMENT
3Ø3W, Y or Δ
FORM 8S & 9S with bypass

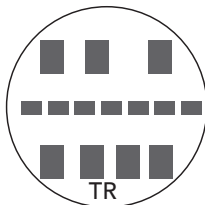

2 ELEMENT
3Ø4W Y
FORM 6S

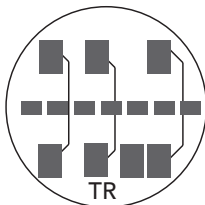

2 ELEMENT
3Ø4W Y FORM 6S
with bypass



Please consult serving utility for their requirements prior to ordering or installing, as specifications and approvals vary by utility, and may require local electrical inspector approval. All installations must be installed by a licensed electrician and must comply with all national and local codes, laws and regulations. Milbank reserves the right to make changes in specifications and features shown without notice or obligation.

Meter Forms

Reference Information

DIAGRAM A
1Ø2W with 1 P.T. and 1 C.T.
Single Stator Meter (2W1Ø) - Form 3S
5T Socket, Test Switch #TS04-0101

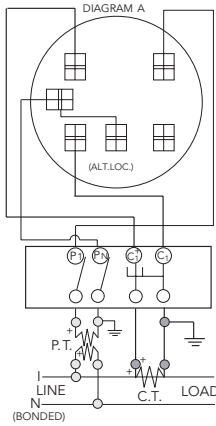

DIAGRAM B
1Ø3W with 1 C.T.
Single Stator Meter (2W1Ø) - Form 3S
5T Socket, Test Switch #TS04-0101

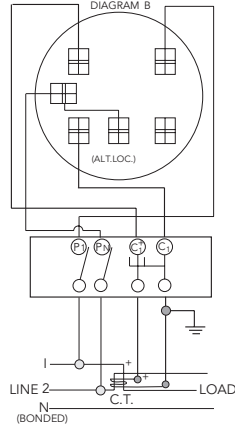

DIAGRAM C
1Ø3W with 2 C.T.'s
Single Stator Meter (3W1Ø) - Form 4S
6T Socket, Test Switch #TS07-0105

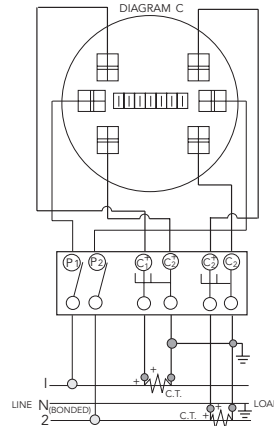

DIAGRAM D
1Ø3W or 3W Network with 2 C.T.'s
2 Stator Meter - Form 5S
8T Socket, Test Switch #TS07-0105

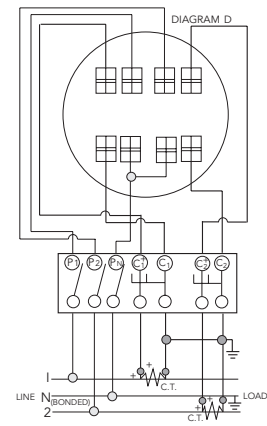

DIAGRAM E
3Ø3W "Δ" with 2 P.T.'s and 2 C.T.'s
2 Stator Meter - Form 5S
8T Socket, Test Switch #TS07-0105

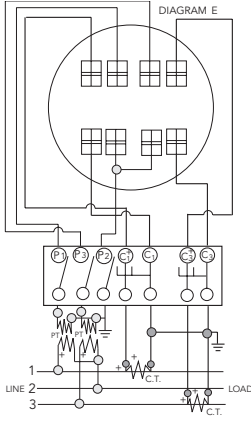

DIAGRAM F
3Ø3W "Δ" with 2 C.T.'s
2 Stator Meter - Form 5S
8T Socket, Test Switch #TS07-0105

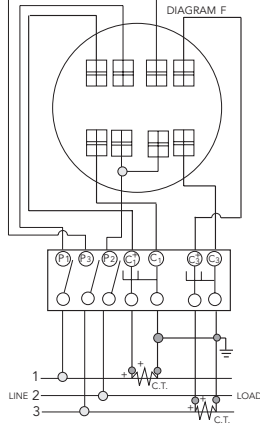

DIAGRAM G
3Ø4W "Y" with 3 C.T.'s
2 1/2 Stator Meter - Form 6S
13T Socket, Test Switch #TS10-0109

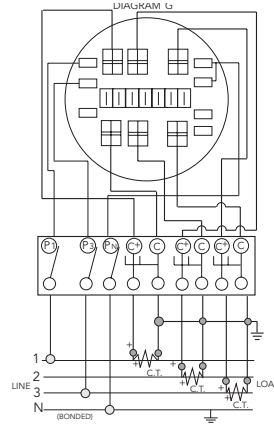

DIAGRAM H
3Ø4W "Y" with 2 P.T.'s and 3 C.T.'s
2 1/2 Stator Meter - Form 6S
13T Socket, Test Switch #TS10-0109

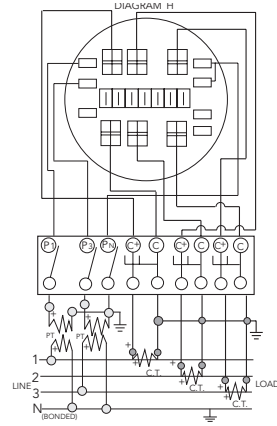

DIAGRAM I
3Ø4W "Y" or "Δ" with 3 C.T.'s
"Y" 3 Stator Meter - Form 9S
"Δ" 2 Stator Meter - Form 8S
13T Socket, Test Switch #TS10-0109

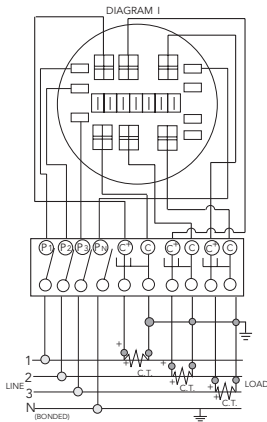
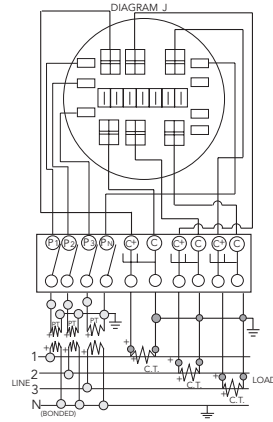

DIAGRAM J
3Ø4W "Y" with 3 P.T.'s and 3 C.T.'s
3 Stator Meter - Form 9S
13T Socket, Test Switch #TS10-0109



Prewiring

If standard factory prewiring is required, refer to wiring diagrams on this page. Determine appropriate diagram and send a copy with order. If custom factory prewiring is required, specify on order. Be sure to include meter socket catalog number, test switch make and catalog number, meter form number and provide a copy of your wiring diagram.

Please consult serving utility for their requirements prior to ordering or installing, as specifications and approvals vary by utility, and may require local electrical inspector approval. All installations must be installed by a licensed electrician and must comply with all national and local codes, laws and regulations. Milbank reserves the right to make changes in specifications and features shown without notice or obligation.



MAXIMUM NUMBER OF CONDUCTORS IN CONDUIT

Table from 2008 NEC Code Reference: Rigid Metal Conduit

Type	Conductor Size (AWG/kcmil)	Conduit Trade Sizes (Inches)									
		1/2	3/4	1	1 1/4	1 1/2	2	2 1/2	3	3 1/2	4
THHN, THWN, THWN-2	12	9	16	26	46	62	102	146	225	301	387
	10	6	10	17	29	39	64	92	142	189	244
	8	3	6	9	16	22	37	53	82	109	140
	6	2	4	4	12	16	27	38	59	79	101
	4	1	2	4	7	10	16	23	36	48	62
	3	1	1	3	6	8	14	20	31	41	53
	2	1	1	3	5	7	11	19	26	34	44
	1	1	1	1	4	5	8	12	19	25	35
	1/0	1	1	1	3	4	7	10	16	21	27
	2/0	0	1	1	2	3	6	8	13	18	23
XHH, XHHW, XHHW-2	3/0	0	1	1	1	3	5	7	11	15	19
	4/0	0	1	1	1	2	4	6	9	12	16
	4	1	2	4	7	10	16	24	37	49	63
	2	1	1	3	5	7	12	17	26	35	45
	1/0	1	1	1	3	4	7	10	16	22	28
	2/0	0	1	1	2	3	6	9	13	18	23
	4/0	0	1	1	1	2	4	6	9	12	16
	250	0	0	1	1	1	3	5	7	10	13
	350	0	0	1	1	1	2	3	6	7	10
	500	0	0	0	1	1	1	2	4	5	7
750	0	0	0	0	1	1	1	3	4	5	

This table is for concentric stranded conductors only. For cables with compact conductors refer to NEC. Refer to latest NEC Code or Local Codes for updated requirements.

SAMPLE RATING LABEL

CATALOG NUMBERS U5952 & U5953
100A MAXIMUM, 120/240 VAC SINGLE PHASE, THREE WIRE
RAINFOOF NEMA TYPE 3R

SHORT CIRCUIT CURRENT RATING IS 10,000 RMS SYMMETRICAL AMPERE AT 240 VAC MAXIMUM, BUT IS LIMITED TO THE LOWEST SHORT CIRCUIT CURRENT RATING OF ANY INSTALLED CIRCUIT BREAKER. WATTHOUR METER NOT INCLUDED IN SHORT CIRCUIT CURRENT RATING. REPLACEMENT CIRCUIT BREAKER MUST BE THE SAME TYPE AND RATING. USE SIEMENS QP, QT; CUTLER-HAMMER QP, BD, BR; SQUARE D HOMELINE; G.E. TQ, THQ, THQL.

SUITABLE FOR USE AS RECREATIONAL VEHICLE SITE SUPPLY EQUIPMENT

UNDERGROUND FEED ONLY

ON TRIP OFF

TO RESET BREAKER MOVE TO "OFF" THEN TO "ON"

DANGER
HAZARD OF ELECTRICAL SHOCK OR BURN
TURN OFF POWER
SUPPLYING THIS EQUIPMENT BEFORE WORKING INSIDE

WIRE TERMINAL INFORMATION USE AL-CU CONDUCTORS			SHIPPING TENDS TO LOOSEN BOLTED CONNECTIONS. CHECK AND TIGHTEN ALL HARDWARE BEFORE ENERGIZING UNIT.
TERMINAL	WIRE RANGE	TORQUE LB-IN	
LINE AND LINE NEUTRAL	350 kcmil - # 6	250	SIZE OF FIELD INSTALLED CONDUCTORS SHALL BE 60° OR 75° C SIZED TO 60° C RATING FOR 110 AMPS OR LESS AND 75° C SIZED TO 75° C FOR 125 AMPS AND ABOVE.
GROUND CONNECTOR	250 AWG - #14 AWG	120	
LOAD NEUTRAL SLOTTED HEAD	(LARGE HOLE)	14 - 10	35
		8	40
		6 - 4	45
LOAD NEUTRAL SLOTTED HEAD	(SMALL HOLE)	14 - 10	20
		8	25
		6	35

* ALLOWABLE AMPACITIES OF INSULATED COPPER and ** ALUMINUM CONDUCTORS (3W IN CONDUIT) 75° C (167° F)

A		AL or **CU-Clad AL	
A	B	A	B
18	—	—	—
16	—	—	—
14	20†	—	—
12	25†	12	20†
10	35†	10	30†
8	50	8	40
6	65	6	50
4	85	4	65
3	100	3	75
2	115	2	90
1	130	1	100
1/0	150	1/0	120
2/0	175	2/0	135
3/0	200	3/0	155
4/0	230	4/0	180
250	255	250	205
300	285	300	230
350	310	350	250
400	335	400	270
500	380	500	310
600	420	600	340
700	460	700	375
750	475	750	385

A = Size: AWG/MCM
 *B = Ampere Rating for Insulation Types:
 FEPW, RH, RHW, THW, THWN, XHHW, USE, 2W.
 **C = Ampere Rating for Insulation Types:
 RH, RHW, THW, THWN, XHHW, USE (Per NEC table 310-16)

AMPACITY CORRECTION FACTORS

Ambient Temp. C°	Correction Factor	Ambient Temp. F°
21 - 25	1.05	70 - 77
25 - 30	1.00	78 - 86
31 - 35	.94	87 - 95
36 - 40	.88	96 - 104
41 - 45	.82	105 - 113
46 - 50	.75	114 - 122
51 - 55	.67	123 - 131
56 - 60	.58	132 - 140
61 - 65	.33	141 - 158

GANG SOCKET OVERALL AMPACITIES

# of Meter Pos.	100A/Pos. Ampacity	125A/Pos. Ampacity	150A/Pos. Ampacity	200A/Pos. Ampacity
2	200A	200A	200A	200A #
3	200A	225A	225A	270A
4	200A	250A	270A	360A
5	225A	285A	338A	450A
6	270A	330A	396A	528A

Overall Ampere ratings of UL-listed Milbank multiple position meter sockets are based on **2008 NEC Handbook Article 220-84** and **ANSI / UL-414** (except where restricted by line connector size). These requirements provide for a diversity factor / demand factor being utilized in determining the overall (main bus / lug) rating of a gang socket. All Milbank UL-listed gang sockets meet or exceed these diversity factor/demand and factor requirements. Standard overall Ampacity ratings for UL-listed and non-UL-listed gang sockets are as shown in the chart below. Ampere ratings of meter sockets are based on the meter socket being wired with 75° C insulated wire conductor, sized in accordance with **Table 310-16** of the **National Electric Code**.

† Unless otherwise permitted elsewhere in the Code, the overcurrent protection for conductor types marked with an obelisk (†) shall not exceed 15 Amps for 14 AWG, 20 Amps for 12 AWG, and 30 Amps for 10 AWG copper; or 15 Amps for 12 AWG and 25 Amps for 10 AWG aluminum and copper-clad aluminum after any correction factors for ambient temperature and number of conductors have been applied.

Some constructions are rated at 400 Amps overall (1252). Contact your sales representative for more information. Refer to latest NEC Code or Local Codes for updated requirements.



Please consult serving utility for their requirements prior to ordering or installing, as specifications and approvals vary by utility, and may require local electrical inspector approval. All installations must be installed by a licensed electrician and must comply with all national and local codes, laws and regulations. Milbank reserves the right to make changes in specifications and features shown without notice or obligation.

Important Information for Installers

Important Note

In addition to national and local electrical codes, many utilities have specific requirements for metering equipment. Always consult the serving utility for their specifications and requirements prior to ordering or installing Milbank meter mounting equipment.

Before Energizing

1. Give equipment a thorough visual examination to determine that:
 - A. No shipping or installation damage exists.
 - B. Proper clearances have been maintained.
 - C. All connections have been made.
 - D. Equipment is clean and dry.
2. Make a thorough examination to:
 - A. Verify tightness of all bolted connections (see table below).
 - B. Manually operate all circuit breakers, switches, relays, etc.
 - C. Check rigidity of all mountings, bus bars and components.
 - D. Use test equipment to check continuity of circuitry and integrity of insulation.
3. All switches and circuit breakers should be in the "off" position.
4. Verify that manual meter bypass (if applicable) is in non-bypass position.
5. Install cover and/or close doors.
6. If installation is not being energized at this time, follow "after-energizing" steps listed below. These steps will secure the installation in case of accidental energization.

When Energizing

Use caution and follow established safety procedures:

- 1) Wear safety apparel.
- 2) Use safety equipment.
- 3) Take action to prevent injury to yourself and others in the event of failure of the installation.
- 4) Take action to prevent/decrease damage to property in the event of failure of the installation.
- 5) If you are unsure how to safely energize the installation, get someone who is knowledgeable to do it.

After Energizing

Secure the installation:

- 1) To prevent accidental contact with energized parts, cover all openings with approved filler devices.
- 2) To prevent unauthorized access, secure all covers and/or doors with approved security devices.
- 3) Attach/post information to advise others of potential hazards associated with the installation.

Recommended Torque for General Applications*

Nominal Size	Joint Description		Head Type	Torque (Inch Lbs.)
	Screw	Nut		
10	Brass	Brass Nut or Extruded Hole	All	20-25 inch lbs.
10	Steel	Copper or Aluminum Busbar ≤ 1/8"	All	25-30 inch lbs.
10	Steel	Steel Nut or Extruded Hole; CU or AL Busbar > 1/8"	All	30-35 inch lbs.
12	Steel	Aluminum Extruded Hole	All	30-35 inch lbs.
12	Steel	Steel Nut or Extruded Hole	All	40-50 inch lbs.
1/4	Steel	Aluminum Extruded Hole	All	40-50 inch lbs.
1/4	Steel	Steel Nut or Extruded Hole; CU or AL Busbar	All	50-60 inch lbs.
5/16	Steel	Aluminum Extruded Hole	Hex	60-70 inch lbs.
5/16	Steel	Steel Nut or Extruded Hole; CU or AL Busbar	Hex	100-150 inch lbs.
3/8	Steel	Steel Nut	Hex	150-200 inch lbs.
1/2	Steel	Steel Nut	Hex	200-250 inch lbs.

* Interior labels typically indicate the required torque for wire connectors and studs, and should be referenced first.
CU: Copper
AL: Aluminum

Please consult serving utility for their requirements prior to ordering or installing, as specifications and approvals vary by utility, and may require local electrical inspector approval. All installations must be installed by a licensed electrician and must comply with all national and local codes, laws and regulations. Milbank reserves the right to make changes in specifications and features shown without notice or obligation.



Materials

Steel Quality

The meter equipment listed in this catalog is made of galvanized steel (AISI* G90) to afford the best possible weather proofing.
*American Iron and Steel Institute.

Steel Sheet

16-gauge, galvanized, sheet: 1 1/4 oz./ sq.ft. class zinc-coated. (AISI G90)
14-gauge, galvanized, sheet: 1 1/4 oz./ sq.ft. class zinc-coated.

Aluminum Extrusion

Wire-Terminal: Alloy; 6061-T6, Tin-plated for CU/AL wire.
Bus Bar: Alloy; 6101-O and 6063-O

Aluminum Sheet

3000 series aluminum sheet, H14, or 5052 series aluminum sheet, H32. Where applicable thicknesses range from .064-.125.

Copper Sheet and Bus

Electrolytic copper with tin plating in most applications.

Insulating Materials

- In most units, support bases for current-carrying components are molded from fiberglass reinforced high-strength, track resistant, thermoset polyester molding compounds.
- Clear or black safety shields and polarity barriers are molded from high-strength, track resistant, polycarbonate molding compounds.
- Various sheet insulating materials, as appropriate for the application are utilized in the fabrication of flat, formed and punched component parts and barriers.

Finish

Process

Light gray state-of-the-art electrostatically applied powder paint offers a durable, non-fading finish. For further information concerning the chemical analysis of the weather resistant finish, please contact the factory.

Metal Fasteners

Zinc-coated with a chromate dip.

Ratings and Compliance

Ratings and Compliance

All Milbank electrical enclosures in this catalog are rated "Type 3R Enclosure" unless specified otherwise on the product's page. All enclosures with a UL designation are constructed per the appropriate UL Standard and may be installed per the National Electric Code. UL procedure files associated with the UL Standards are listed as follows: Meter Sockets (UL 414, File E30202), Test Switches (UL 414, File E62531), Power Outlets (UL 231, File E90945), Panelboards (UL 67, File E32628) and Pullout Switches (UL 1429, File E133062). Additional standards are utilized as applicable: Meter Sockets (ANSI C12.7), Test Switches (ANSI C12.9) and Panelboards (NEMA PB-1).



Please consult serving utility for their requirements prior to ordering or installing, as specifications and approvals vary by utility, and may require local electrical inspector approval. All installations must be installed by a licensed electrician and must comply with all national and local codes, laws and regulations. Milbank reserves the right to make changes in specifications and features shown without notice or obligation.

Symbols			
5T8K2.....	36	K5920-111GR.....	25
6002.....	35	K5920-522.....	25
6003.....	35	K5920-BLANK.....	25
6116.....	35	K8180.....	35
708784-MO.....	31		
*U5898-O-200**.....	13		
		M	
		M5-144.....	35
		MR-2.....	31
A		Q	
A7514.....	34	Q115.....	33
A7515.....	34	Q115H.....	33
A7516.....	34	Q120.....	31, 33
A7517.....	34	Q120H.....	33
A7518.....	34	Q125.....	33
A7551.....	34	Q125H.....	33
A8110.....	34	Q130.....	31, 33
A8111.....	34	Q130H.....	33
A8112.....	34	Q135.....	33
A9064.....	34	Q135H.....	33
		Q140.....	33
		Q140H.....	33
		Q150.....	33
		Q150H.....	33
		Q160.....	33
		Q160H.....	33
		Q170.....	33
		Q170H.....	33
		Q215.....	33
		Q215H.....	33
		Q220.....	33
		Q220H.....	33
		Q225.....	33
		Q225H.....	33
		Q230.....	33
		Q230H.....	33
		Q235.....	33
		Q235H.....	33
		Q240.....	33
		Q240H.....	33
		Q250.....	31, 33
		Q250H.....	33
		Q260.....	33
		Q260H.....	33
		Q270.....	33
		Q270H.....	33
		Q280.....	33
		Q280H.....	33
		Q290.....	33
		Q290H.....	33
		Q2100.....	33
		Q2100H.....	33
		Q2125.....	33
		Q2125H.....	33
		QN2150.....	33
		QN2150H.....	33
		QN2150R.....	33
		QN2150RH.....	33
		QN2200.....	33
		QN2200H.....	33
		QN2200R.....	33
		QN2200RH.....	33
		S	
		S8324.....	34
		U	
		U1252-REL-K1.....	18
		U1253-X.....	18
		U1254-X.....	18
		U1255-X.....	18
		U1256-X.....	18
		U1797-O-K3L-K2L*.....	10
		U1980-O.....	8
		U2120-X.....	11
		U2594-X.....	11
		U3802.....	6
		U3812.....	6
		U3822-20GWR.....	7
		U3832.....	6
		U3862.....	6
		U4184-X*.....	9
		U4252-RXL-K2.....	18
		U4413-O.....	8
		U4419-X.....	10
		U4505-X.....	10
		U4581-RL-QG.....	9
		U4701-RL-QG.....	9
		U4702-X.....	10
		U4905-X*.....	10
		U4908-O-11GR.....	21
		U4908-O-100MB-11GR.....	22
		U5000-XL.....	23
		U5000-XL-41.....	23
		U5000-XL-55.....	23
		U5000-XL-75.....	23
		U5100-XL.....	23
		U5100-XL-41.....	23
		U5100-XL-55.....	23
		U5100-XL-75.....	23
		U5101-XL-11GR.....	21
		U5101-XL-100MB-11GR.....	22

Please consult serving utility for their requirements prior to ordering or installing, as specifications and approvals vary by utility, and may require local electrical inspector approval. All installations must be installed by a licensed electrician and must comply with all national and local codes, laws and regulations. Milbank reserves the right to make changes in specifications and features shown without notice or obligation.



U5168-XTL-100**	13	U8212-RL	18
U5168-XTL-150**	13	U8213-RL	18
U5168-XTL-200**	13	U8214-RL	18
U5200-XL	24	U8215-RL	18
U5200-XL-41	24	U8216-XL	18
U5200-XL-55	24	U8435-RL-TG	8
U5200-XL-75	24	UQFB-100	32
U5220-XL	24	UQFB-100-X1	32
U5220-XL-41	24	UQFB-125	32
U5220-XL-55	24	UQFB-125-X1	32
U5220-XL-75	24	UQFB-150	32
U5268-XTL-200	13	UQFB-150-X1	32
U5300-O	24	UQFB-175	32
U5300-O-41	24	UQFB-175-X1	32
U5300-O-55	24	UQFB-200	32
U5300-O-75	24	UQFB-200-X1	32
U5320-O	24	UQFBH-100	32
U5320-O-41	24	UQFBH-125	32
U5320-O-55	24	UQFBH-150	32
U5320-O-75	24	UQFBH-175	32
U5750-RXL-200-BL	14	UQFBH-200	32
U5842-RL-100	12	UQFBH-M-100	32
U5842-RL-200	12	UQFBH-M-125	32
U5844-PXL	12	UQFBH-M-150	32
U5844-PXL-100	12	UQFBH-M-175	32
U5844-PXL-150	12	UQFBH-M-200	32
U5844-PXL-200	12	UQFP-100	32
U5882-X	19	UQFP-125	32
U5883	19	UQFP-150	32
U5884-X	19	UQFP-175	32
U5885-X	19	UQFP-200	32
U5886-X	19	UQFPH	32
U5902-X	19	UQFPH-100	32
U5903-X	19	UQFPH-125	32
U5904-X	19	UQFPH-175	32
U5905-X	19	UQFPH-200	32
U5906-X	19	UQFPH-M-100	32
U5971-XL-100	12	UQFPH-M-125	32
U5971-XL-150	12	UQFPH-M-150	32
U5971-XL-200	12	UQFPH-M-175	32
U6047-O-K3L-K2L*	10	UQFPH-M-200	32
U6227-X-400	16	UQFP-M-100	32
U6228-X-400	16	UQFP-M-125	32
U6229-X-400	16	UQFP-M-150	32
U6230-X-400	16	UQFP-M-175	32
U6585-X-2/200-K3L	15	UQFP-M-200	32
U6585-X-2/200-K3L-5T9-AMS	15		
U6601-X-2/200	15		
U6603-X-2/200	15		
U6605-X-2/200-MLK-ENT	15		
U7021-RL-TG	8		
U7040-RL-TG	8		

Z

Z701776-MO	31
Z708080-MO	31
Z708767-MO	31
Z818052-SC	31
Z915141-AC	31
Z917602-AC	31
Z918449-AC	31
Z918466-AC	31

W

WBJ2150	33
WBJ2200	33



Please consult serving utility for their requirements prior to ordering or installing, as specifications and approvals vary by utility, and may require local electrical inspector approval. All installations must be installed by a licensed electrician and must comply with all national and local codes, laws and regulations. Milbank reserves the right to make changes in specifications and features shown without notice or obligation.



MILBANK[®]
ENERGY AT WORK

Milbank Manufacturing | 4801 Deramus Ave., Kansas City, MO 64120 | 877.483.5314
milbankworks.com | @milbankworks