

# Isolated Neutral Kits

*All kits include isolating blocks and hardware to be installed under existing neutral bar*

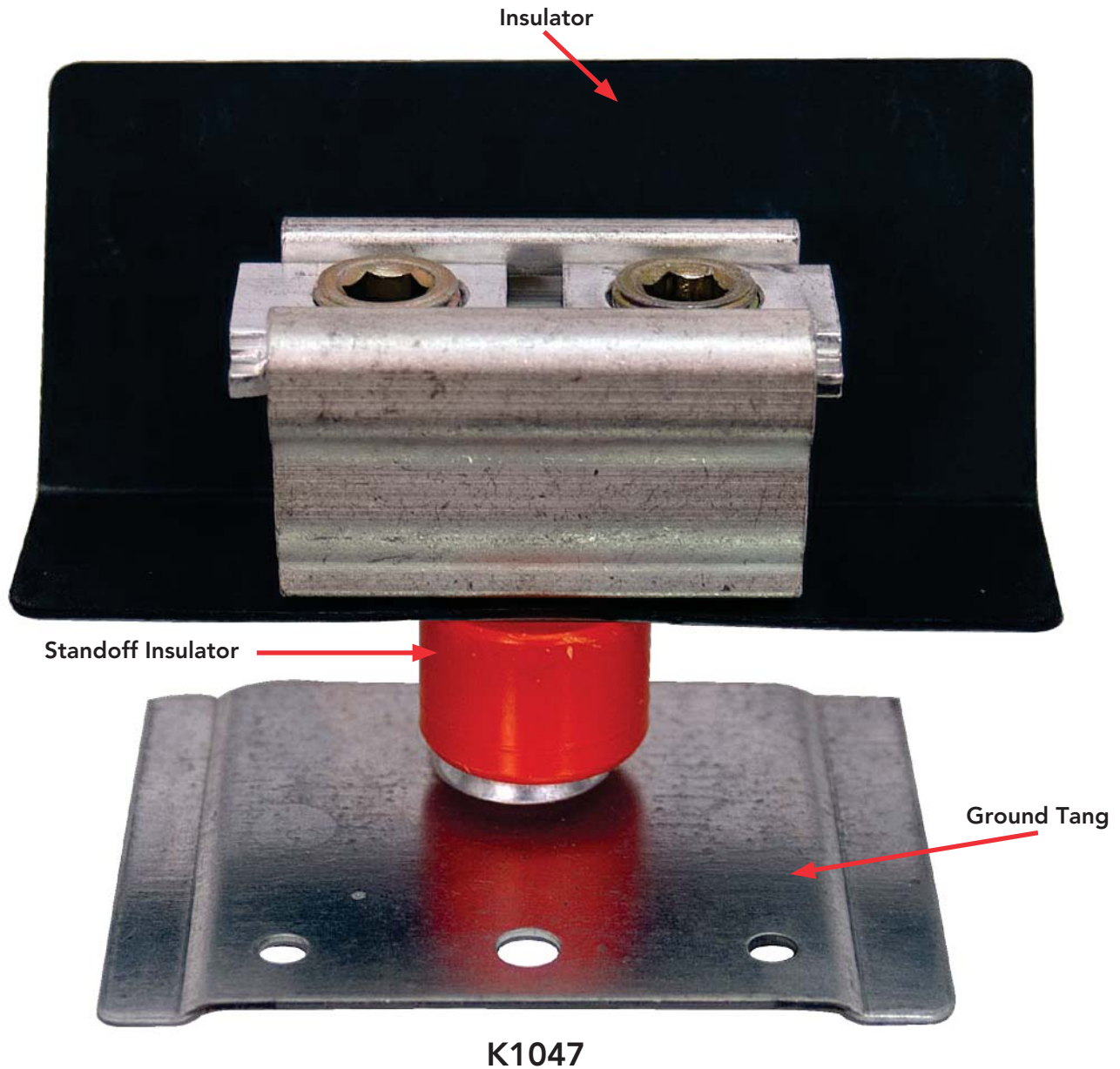

Please consult serving utility for their requirements prior to ordering or installing, as specifications and approvals vary by utility, and may require local electrical inspector approval. All installations must be installed by a licensed electrician and must comply with all national and local codes, laws and regulations. Milbank reserves the right to make changes in specifications and features shown without notice or obligation.



# Isolated Neutral Kits

All kits include isolating blocks and hardware to be installed under existing neutral bar

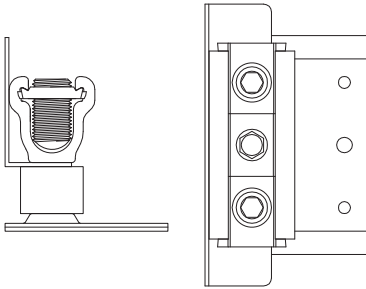

K1047

## K1047

200 amp

For use with the following series:

1854, 2046, 2145, 2810, 3061, 3328, 4701,  
4788, 4910, 5127, 7422, 7423, 8606, 9701, 9707

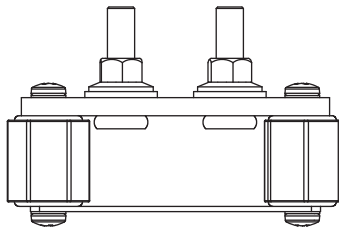
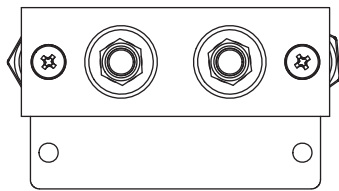

K5977

## K5977

320 amp

For use with the following series:

2120, 2448, 2594, 2827, 4013, 4168, 4257,  
4260, 4487, 4596, 4741, 4776, 4980, 5036

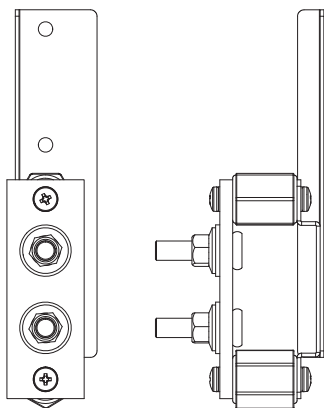

K5978

## K5978

320 amp

For use with the following series:

1129\*, 1729, 1797, 1897, 3000

\*Cannot be used on U1129 with -MVE suffix



Please consult serving utility for their requirements prior to ordering or installing, as specifications and approvals vary by utility, and may require local electrical inspector approval. All installations must be installed by a licensed electrician and must comply with all national and local codes, laws and regulations. Milbank reserves the right to make changes in specifications and features shown without notice or obligation.

# Isolated Neutral Kits

All kits include isolating blocks and hardware to be installed under existing neutral bar

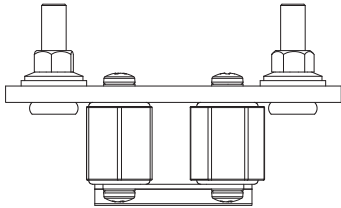
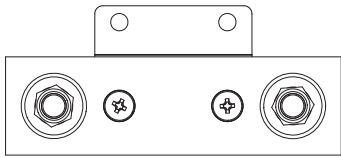

K5979

## K5979

320 amp

For use with the following series:

**4505, 4702, 5740**

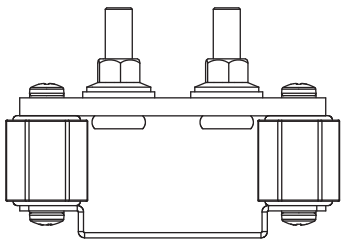

K5980

## K5980

320 amp

For use with the following series:

**5161**

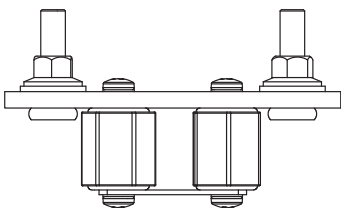
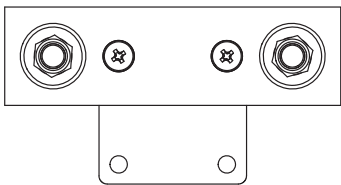

K5984

## K5984

320 amp

For use with the following series:

**4342, 4362, 4778, 4911, 5786**

Please consult serving utility for their requirements prior to ordering or installing, as specifications and approvals vary by utility, and may require local electrical inspector approval. All installations must be installed by a licensed electrician and must comply with all national and local codes, laws and regulations. Milbank reserves the right to make changes in specifications and features shown without notice or obligation.



**MILBANK**  
ENERGY AT WORK

# Isolated Neutral Kits

All kits include isolating blocks and hardware to be installed under existing neutral bar

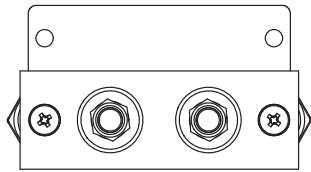

**K5985**

**320 amp**

For use with the following series:

**1432, 4905, 5155**

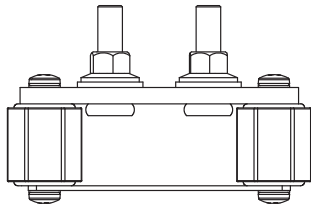

K5985

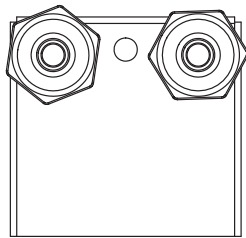

**K5986**

**320 amp**

For use with the following series:

**4363, 4741, 5052**

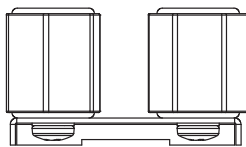

K5986

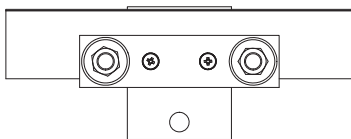

**K6024**

**320 amp**

For use with the following series:

**3566**

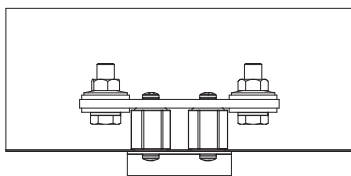

K6024



Please consult serving utility for their requirements prior to ordering or installing, as specifications and approvals vary by utility, and may require local electrical inspector approval. All installations must be installed by a licensed electrician and must comply with all national and local codes, laws and regulations. Milbank reserves the right to make changes in specifications and features shown without notice or obligation.