

MILBANK[®]
ENERGY AT WORK

WISCONSIN AREA

Meter Mounting Equipment



Milbank Manufacturing is the premier manufacturer of metering equipment, enclosures and enclosed controls in the United States.

Milbank designs and manufactures electrical solutions that move and manage power for the residential, commercial, industrial, utility and transportation sectors. With nearly a century of expertise in electrical engineering design and manufacturing, Milbank's portfolio includes metering equipment, enclosures and enclosed controls. Founded in 1927, Milbank is a family-owned, American manufacturer headquartered in Kansas City, Mo. For more information, please visit milbankworks.com.



Metering

Milbank has been a market leader in electrical metering equipment, setting the standard in quality, for 95 years and counting. Hundreds of configurations are available, including many sizes, knockout configurations, terminals configurations, bypass options, hubs, locks and connectors. Milbank has the socket you need with thousands of active products to meet your utility's requirements.



Enclosures

Milbank's line of enclosures include commercial junction boxes, panel mount enclosures, transformer cabinets, wireway and troughs. Enclosures are built with high-quality craftsmanship and materials, designed to meet or exceed industry standards. Each unit is engineered to protect controls and equipment from dust, dirt and other harmful elements, based on various NEMA ratings.



Enclosed Controls

Milbank doesn't just build empty enclosures, we can design and craft the entire package. Our enclosed controls are custom control equipment that's built to your exact specifications by our engineers. Milbank enclosed controls are an attractive, secure, easy-to-install and cost-effective solution. These units can replace unsightly and insufficient strut and backboard structures when underground remote site power distribution and control equipment is required.



Please consult serving utility for their requirements prior to ordering or installing, as specifications and approvals vary by utility, and may require local electrical inspector approval. All installations must be installed by a licensed electrician and must comply with all national and local codes, laws and regulations. Milbank reserves the right to make changes in specifications and features shown without notice or obligation.

Air Conditioner Disconnects

30-60 Amps AC Disconnects	4-5
Hot Tub Disconnects.....	6

Single Position Sockets

125 Amps, 4 Terminals, Ringless	7
200 Amps, 4 Terminals, Ringless	8
200 Amps, 4-5 Terminals, Lever Bypass, Ringless.....	9
200 Amps, 5 Terminals, Lever Bypass, Ringless.....	10
320 Amps, 4-5 Terminals, Lever Bypass, Ringless.....	11
125-320 Amps, 7 Terminals, Lever Bypass, Ringless	12-14

Meter Mains

100-200 Amps, 4 Terminals, Ringless.....	15
200 Amps, 4 Terminals, with Load Center, Ringless	16
200 Amps, 7 terminals, Cold Sequence Meter Mains	17

Multi-Position

100-200 Amps, 4 Terminals, Ringless.....	18-23
200 Amps, 5-7 Terminals, Lever Bypass, Ringless.....	24-26
125-200 Amps, 4 Terminals, Meter Mains, Ringless.....	27-28

Transformer Rated Sockets

20 Amps, 5-13 Terminals, Ringless.....	29
20 Amps, Multi-position, 8-13 Terminals, Ring Type	30

Pedestals

200 Amps, 4 Terminals, Ringless	31
100-200 Amps, 4-7 Terminals, Ringless.....	32-33
320 Amps, 4-5 Terminals, Ringless	34
100-200 Amps, 4 Terminals, Ringless.....	35-37
100-200 Amps, 5 Terminals, Meter Main with Load Center, Lever Bypass, Ringless	38-39
320 Amps, 4 Terminals, Meter Main with Breakers, Lever Bypass, Ringless.....	40

Miscellaneous

Joint Use Termination Cabinet	41
Polyphase Enclosures for A-base Meters	42
Type K4-K7 Meter Sockets	43-45
Lugs for K-Series	46
Enclosed Controls	47-55
Circuit Breakers	56-57
Accessories	58-60
Commerical Enclosures	61
Reference Information	62-66
Utility Approvals Chart	67-69
Index.....	70-71

Please consult serving utility for their requirements prior to ordering or installing, as specifications and approvals vary by utility, and may require local electrical inspector approval. All installations must be installed by a licensed electrician and must comply with all national and local codes, laws and regulations. Milbank reserves the right to make changes in specifications and features shown without notice or obligation.



Air Conditioner Disconnects

30-60 Amps | Fusible and Non-Fusible



U3802



U3812



U3832

Milbank’s air conditioner disconnect has a removable hinged cover which makes wiring a breeze. Our compact design meets all NEC wire bending space requirements and also complies with article 440-14 in the NEC. To ensure the safest conditions, we designed our disconnect pullers to be removable or they may be reinstalled in the off position. Safety features also included are the padlock provision on the front cover.

As with all Milbank products, our enclosure is constructed of G90 galvanized steel and is finished with an attractive, light-gray, baked powder coating. Our state-of-the-art finish combines epoxy and polyester hybrid resins into a hybrid powder coating which is then electrostatically applied. This offers a durable, non-fading finish.

30–60 Amps | Air Conditioner Disconnects | 1Ø 240V

Catalog Number	Amps	Type	Max H.P.	Weight (lbs.)	Line/Load Wire Range		Ground Wire Range CU/AL	Dimensions			Wire Rating	
					CU	AL		D"	W"	H"	CU °C	AL °C
U3802	60	Non-Fusible	10	3.25	#14-#2	#12-#2	#14-4	2½	5	7½	60°/75°	60°/75°
U3812	60	Non-Auto	10	3.25	#14-#2	#12-#2	#14-4	2½	5	7½	60°/75°	60°/75°
U3832	30	Fusible	3	2.5	#14-#3	#14-#3	#14-3	2⅞	5	7	60°/75°	60°/75°
U3862	60	Fusible	10	3.3	#14-#3	#14-#3	#14-3	2⅞	5	9	60°/75°	60°/75°

Notes

- UL-listed as Enclosed Pullout Switch
- NEMA 3R rain-resistant
- One-inch concentric knockouts



Please consult serving utility for their requirements prior to ordering or installing, as specifications and approvals vary by utility, and may require local electrical inspector approval. All installations must be installed by a licensed electrician and must comply with all national and local codes, laws and regulations. Milbank reserves the right to make changes in specifications and features shown without notice or obligation.

Air Conditioner Disconnects

5

60 Amps | With 20 Amps GFCI Receptacle



U3822-20GWR

Specifications

- Meets NEC #406.8 requirements
- Meets NEC #210.63 requirements
- UL-listed as Power Outlet
- NEMA 3R enclosure
- In-use cover*
- Duplex ground connector
- One-inch concentric knockouts
- 1Ø, 240V
- 60 Amps, non-fused
- 20 Amps GFCI receptacle
- Reset/test button
- Weather and tamper resistant

60 Amps | Air Conditioner Disconnect with 20 Amps GFCI Receptacle | 1Ø, 240V

Catalog Number	Type	Max H.P.	Weight (lbs.)	Line/Load Wire Range		Ground Wire Range CU/AL	Dimensions			Wire Rating	
				CU	AL		D"	W"	H"	CU °C	AL °C
U3822-20GWR	Non-Fusible	10	6	#14-#2	#12-#2	#14-4	4 ⁴ / ₅	5 ¹ / ₄	7 ² / ₅	60°/75°	60°/75°

Notes

- **Disconnect Pullouts:** To ensure the safest conditions, Milbank disconnect pullouts are reversible so they may be reinstalled in the OFF position.
 - **Padlock Provision:** All units are designed with a padlock provision on the cover for security.
- *Rated as an in-use cover (cover may be closed with cords plugged into receptacle).

Please consult serving utility for their requirements prior to ordering or installing, as specifications and approvals vary by utility, and may require local electrical inspector approval. All installations must be installed by a licensed electrician and must comply with all national and local codes, laws and regulations. Milbank reserves the right to make changes in specifications and features shown without notice or obligation.



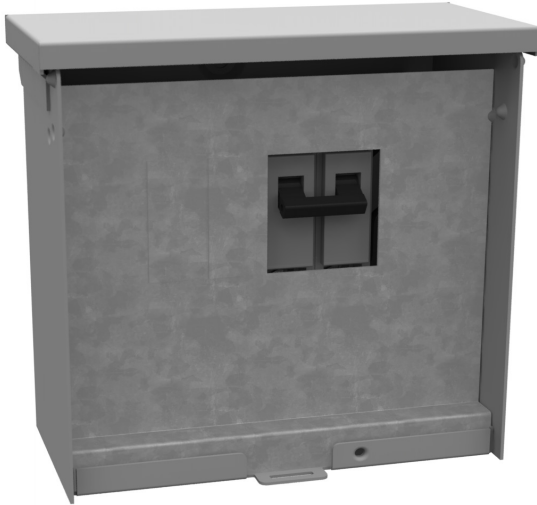

U4881-O-50GB

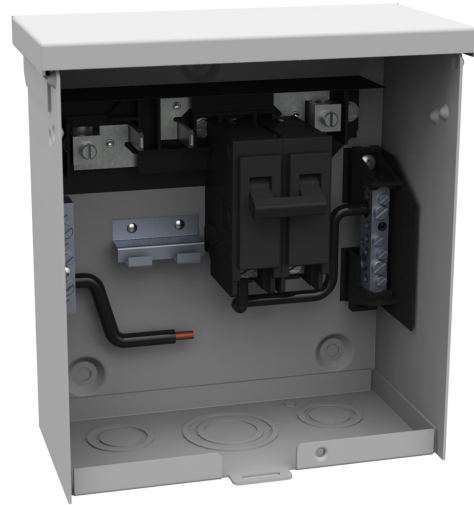

U4881-O-60GB

Specifications

- 240 VAC ground fault protection
- UL-listed, NEMA 3R rain-resistant
- two-pole, 50 or 60 Amps GFCI breaker protection
- Compact size
- Three or four wire installation
- 1Ø, 120/240 VAC
- Standard package of 12
- Two extra one-pole breaker spaces
- 100 Amps overall rating
- Easy to install

100 Amps | Hot Tub Disconnects or Sub Panel Breaker Enclosures | NEMA 3R

Catalog Number	Breaker Amps	Type	Weight (lbs.)	Line/Load Wire Range		Ground Wire Range CU/AL	Dimensions		
				CU	AL		D"	W"	H"
U4881-O	—	Breaker Provision	7	#14-1/0	#14-1/0	#14-1/0	3¾	7½	8½
U4881-O-50GB	50	Breaker	8	#14-1/0	#14-1/0	#14-1/0	3¾	7½	8½
U4881-O-60GB	60	Breaker	8	#14-1/0	#14-1/0	#14-1/0	3¾	7½	8½



Please consult serving utility for their requirements prior to ordering or installing, as specifications and approvals vary by utility, and may require local electrical inspector approval. All installations must be installed by a licensed electrician and must comply with all national and local codes, laws and regulations. Milbank reserves the right to make changes in specifications and features shown without notice or obligation.

Single Position Sockets

125 Amps | 4 Terminals | Ringless | 600 VAC

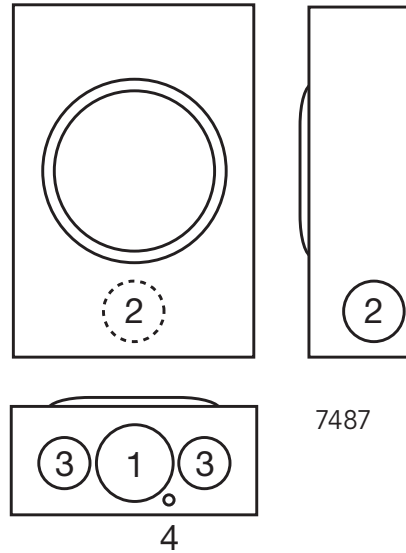
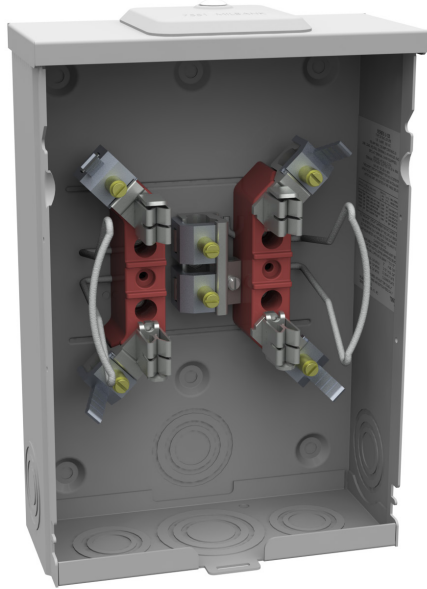

U7487-RL-TG-KK

125 Amps | 4 Terminals | Single Position | Ringless

Catalog Number	Terminals	Service	Hub	Connectors CU/AL		Bypass	Dimensions			Knockouts			
				Line	Load		D"	W"	H"	1	2	3	4
U7487-RL-TG-KK	4	OH	H.O.	#6-2/0	#6-2/0	Horn	3 ⁵ / ₁₆	8	11 ¹ / ₂	2	1 ¹ / ₂	1 ¹ / ₄	1 ¹ / ₄

Notes

- **Hubs:** For proper hub selection, see the hub suffix chart on the accessories page.
- **Bypass:** The horn type bypass is factory-installed and permits changing and testing of the meter without interrupting customer service when used with utility-supplied jumpers.
- **Connectors:** Extruded aluminum connectors are tin plated. Unit is supplied with a triplex neutral.
- **Fifth Terminal:** For field-installable fifth terminal, order catalog number **5T8K2** (must be bolted in).

Please consult serving utility for their requirements prior to ordering or installing, as specifications and approvals vary by utility, and may require local electrical inspector approval. All installations must be installed by a licensed electrician and must comply with all national and local codes, laws and regulations. Milbank reserves the right to make changes in specifications and features shown without notice or obligation.



Single Position Sockets

200 Amps | 4 Terminals | Ringless | 600V

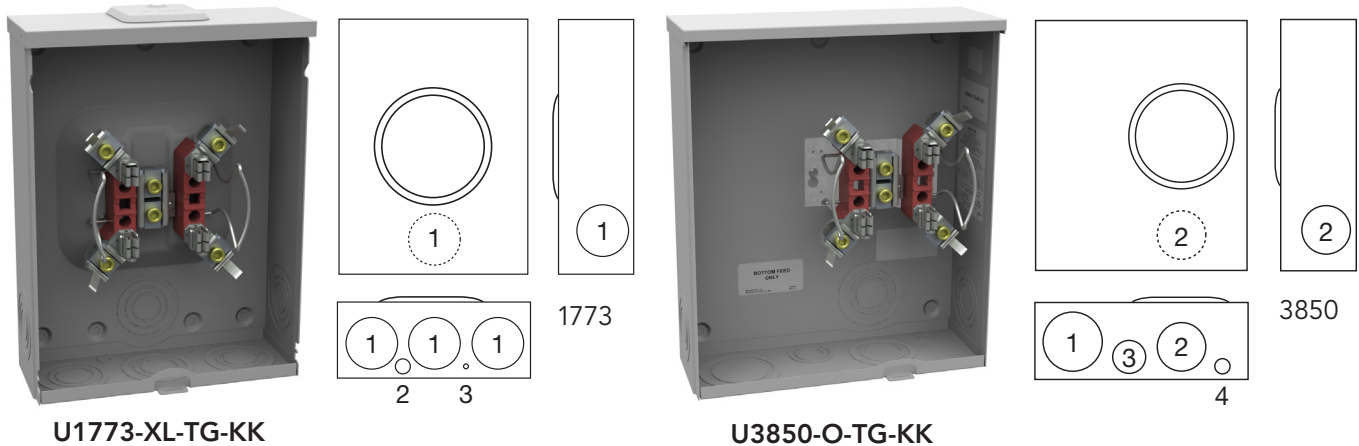

U1773-XL-TG-KK

U3850-O-TG-KK

200 Amps | 4 Terminals | Single Position | Ringless

Catalog Number	Terminals	Service	Hub	Connectors CU/AL		Bypass	Dimensions			Knockouts			
				Line	Load		D"	W"	H"	1	2	3	4
U1773-XL-TG-KK	4	OH	C.P.	#6-350	#6-350	Horn	4 $\frac{1}{8}$	11	15 $\frac{1}{2}$	2 $\frac{1}{2}$	$\frac{1}{4}$, $\frac{1}{2}$	$\frac{1}{4}$	—
U3850-O-TG-KK	4	UG	Blank	#6-350	#6-350	Horn	4 $\frac{1}{2}$	13	15 $\frac{1}{4}$	3	2 $\frac{1}{2}$	1 $\frac{1}{2}$	$\frac{1}{4}$, $\frac{1}{2}$

Notes

- **Hubs:** For proper hub selection, see the hub suffix chart on the accessories page.
- **Bypass:** The horn type bypass is factory-installed and permits changing and testing of the meter without interrupting customer service when used with utility-supplied jumpers.
- **Connectors:** Units are supplied with extruded aluminum connectors and bonded triplex neutral.
- **Fifth Terminal:** For field-installable fifth terminal, order catalog number **K5T** to fit into square opening in the 9 o'clock position



Please consult serving utility for their requirements prior to ordering or installing, as specifications and approvals vary by utility, and may require local electrical inspector approval. All installations must be installed by a licensed electrician and must comply with all national and local codes, laws and regulations. Milbank reserves the right to make changes in specifications and features shown without notice or obligation.

Lever Bypass Single Position Sockets

200 Amps | 4-5 Terminals | Ringless | 600V



U1211-RXL

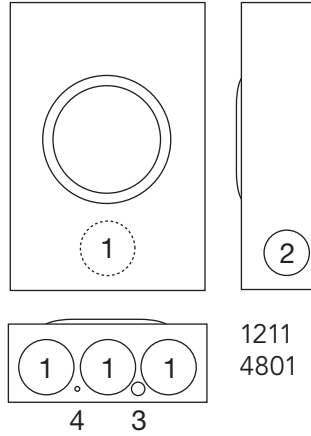

1211
4801



U4801-XL-5T9

200 Amps | 4-5 Terminals | Single Position | Lever Bypass | Ringless

Catalog Number	Terminals	Service	Hub	Connectors CU/AL		Bypass	Dimensions			Knockouts			
				Line	Load		D"	W"	H"	1	2	3	4
U1211-RXL	4	OH	C.P.	#6-350	#6-350	Lever	4 ⁷ / ₈	13	19	3	2 ¹ / ₂	1 ¹ / ₄ , 1 ¹ / ₂	1 ¹ / ₄
U4801-XL	4	OH/UG	C.P.	#6-350	#6-350	Lever	4 ⁷ / ₈	13	19	3	2 ¹ / ₂	1 ¹ / ₄ , 1 ¹ / ₂	1 ¹ / ₄
U4801-XL-5T9	5*	OH/UG	C.P.	#6-350	#6-350	Lever	4 ⁷ / ₈	13	19	3	2 ¹ / ₂	1 ¹ / ₄ , 1 ¹ / ₂	1 ¹ / ₄

Notes

- **Hubs:** For proper hub selection, see the hub suffix chart on the accessories page.
- **Bypass:** The lever on the **U1211** operates bypass only; it does not provide clamping action on meter spades. The **U4801** is a heavy duty lever bypass and the lever supplies clamping action on meter spades.
- **Connectors:** Units are supplied with extruded aluminum connectors and bonded triplex neutral.
- **Fifth Terminal:** For field-installable fifth terminal, order catalog number **K3866**.

*These units include a factory-installed fifth terminal in the 9 o'clock position for use on Alliant Energy lines when a fifth terminal is required.

Please consult serving utility for their requirements prior to ordering or installing, as specifications and approvals vary by utility, and may require local electrical inspector approval. All installations must be installed by a licensed electrician and must comply with all national and local codes, laws and regulations. Milbank reserves the right to make changes in specifications and features shown without notice or obligation.



1 □

Lever Bypass Single Position Sockets

200 Amps | 5 Terminals | Ringless | 600V

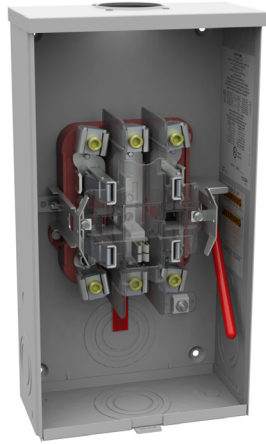

U9550-RL



U9551-O



U8624-RXL

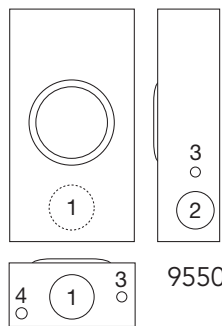

9550

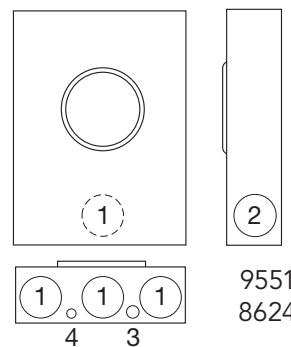

9551
8624

200 Amps | 5 Terminals | Single Position | Lever Bypass | Ringless

Catalog Number	Terminals	Service	Hub	Connectors CU/AL		Bypass	Dimensions			Knockouts			
				Line	Load		D"	W"	H"	1	2	3	4
U9550-RL	5	OH	H.O	#6-350	#6-350	Lever	4 ⁷ / ₈	10	18 ¹ / ₂	3	2 ¹ / ₂	³ / ₄	1 ¹ / ₄ , 1 ¹ / ₂
U9551-O	5	UG	Blank	#6-350	#6-350	Lever	4 ⁷ / ₈	13	19	3	2 ¹ / ₂	1 ¹ / ₄ , 1 ¹ / ₂	1 ¹ / ₄
U8624-RXL	5	OH/UG	H.O	#6-350	#6-350	Lever	4 ⁷ / ₈	13	19	3	2 ¹ / ₂	1 ¹ / ₄ , 1 ¹ / ₂	1 ¹ / ₄

Notes

- **Grounded B Phase:** The **U9550** and **U9551** have a grounded B phase that can be field isolated.
- **Hubs:** For proper hub selection, see the hub suffix chart on the accessories page.
- **Bypass:** The lever operates the bypass device and supplies clamping action on meter spades.
- **Connectors:** Supplied with internal hex connectors. Extruded aluminum connectors are tin plated.



Please consult serving utility for their requirements prior to ordering or installing, as specifications and approvals vary by utility, and may require local electrical inspector approval. All installations must be installed by a licensed electrician and must comply with all national and local codes, laws and regulations. Milbank reserves the right to make changes in specifications and features shown without notice or obligation.

Lever Bypass Single Position Sockets

11

125 Amps | 7 Terminals | Ringless | 600V

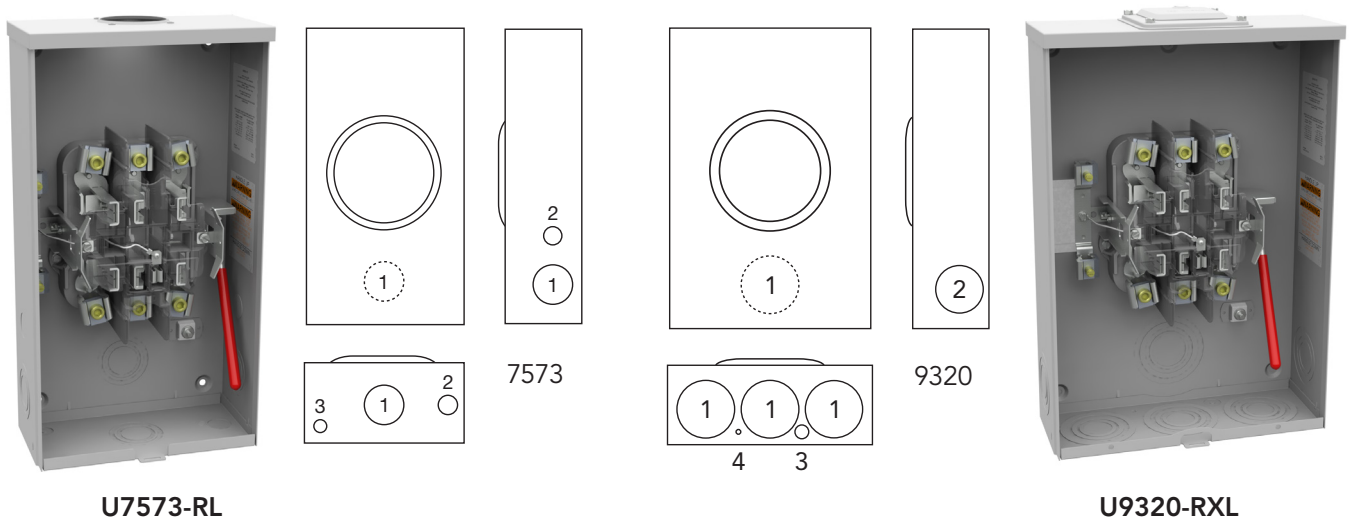

U7573-RL

U9320-RXL

125 Amps | 7 Terminals | Single Position | Lever Bypass | Ringless

Catalog Number	Terminals	Service	Hub	Connectors CU/AL		Bypass	Dimensions			Knockouts			
				Line	Load		D"	W"	H"	1	2	3	4
U7573-RL	7	OH	H.O.	#6-2/0	#6-2/0	Lever	4 ⁷ / ₈	10	18 ¹ / ₂	2	3 ³ / ₄	1 ¹ / ₄ , 1 ¹ / ₂	—
U9320-RXL	7	OH/UG	C.P.	#6-2/0	#6-2/0	Lever	4 ⁷ / ₈	13	19	3	2 ¹ / ₂	1 ¹ / ₄ , 1 ¹ / ₂	1 ¹ / ₄

Notes

- **Hubs:** For proper hub selection, see the hub suffix chart on the accessories page.
- **Bypass:** The lever operates bypass only; it does not provide clamping action on meter spades.
- **Connectors:** Units are supplied with extruded aluminum connectors and bonded triplex neutral.

Please consult serving utility for their requirements prior to ordering or installing, as specifications and approvals vary by utility, and may require local electrical inspector approval. All installations must be installed by a licensed electrician and must comply with all national and local codes, laws and regulations. Milbank reserves the right to make changes in specifications and features shown without notice or obligation.



Lever Bypass Single Position Sockets

200 Amps | 7 Terminals | Ringless | 600V

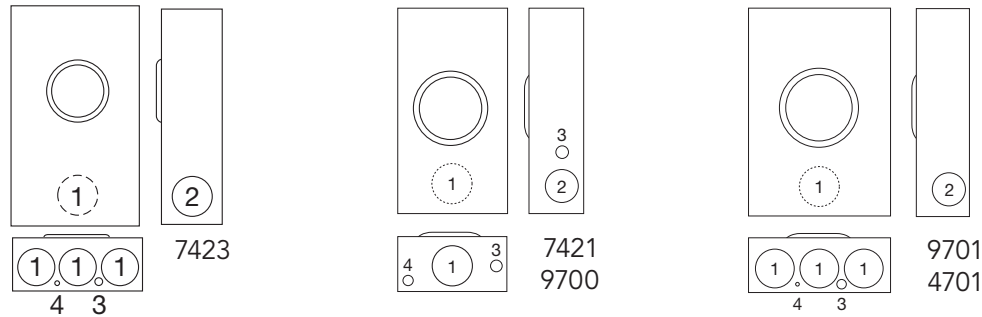
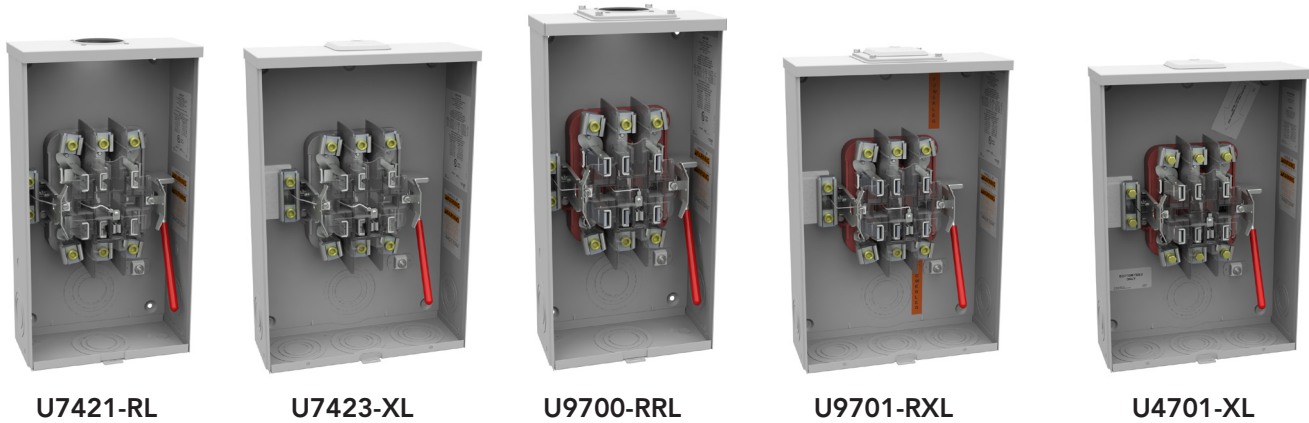

200 Amps | 7 Terminals | Single Position | Medium Duty Lever Bypass | Ringless

Catalog Number	Terminals	Service	Hub	Connectors CU/AL		Bypass	Dimensions			Knockouts			
				Line	Load		D"	W"	H"	1	2	3	4
U7421-RL	7	OH	H.O.	#6-350	#6-350	Lever	4 ⁷ / ₈	10	18 ¹ / ₂	3	2 ¹ / ₂	3 ³ / ₄	1 ¹ / ₄ , 1 ¹ / ₂
U7423-XL	7	OH/UG*	C.P.	#6-350	#6-350	Lever	4 ⁷ / ₈	13	19	3	2 ¹ / ₂	1 ¹ / ₄ , 1 ¹ / ₂	1 ¹ / ₄

200 Amps | 7 Terminals | Single Position | Heavy Duty Lever Bypass | Ringless

Catalog Number	Terminals	Service	Hub	Connectors CU/AL		Bypass	Dimensions			Knockouts			
				Line	Load		D"	W"	H"	1	2	3	4
U9700-RRL	7	OH	H.O.	#6-350	#6-350	Lever	4 ⁷ / ₈	10	18 ¹ / ₂	3	2 ¹ / ₂	3 ³ / ₄	1 ¹ / ₄ , 1 ¹ / ₂
U9701-RXL	7	OH/UG*	C.P.	#6-350	#6-350	Lever	4 ⁷ / ₈	13	19	3	2 ¹ / ₂	1 ¹ / ₄ , 1 ¹ / ₂	1 ¹ / ₄
U4701-XL	7	OH/UG	C.P.	#6-350	#6-350	Lever	4 ⁷ / ₈	13	19	3	2 ¹ / ₂	1 ¹ / ₄ , 1 ¹ / ₂	1 ¹ / ₄

Notes

- **Hubs:** For proper hub selection, see the hub suffix chart on the accessories page.
- **External Hex:** The **U4701** has an external hex bolt in the lugs.
- **Bypass:** The lever in the **U7421** and **U7423** operates the bypass only and does not provide clamping action on meter spades. The lever in the **U9700**, **U9701**, **U4701** supplies clamping action and operates bypass device.
- **Isolated Neutral:** For field-installable isolated neutral for **U9701**, **U7423** and **U4701**, order **K1047**.
- **Connectors:** Units are supplied with extruded aluminum connectors.

*The **U7423** and **U9701** are overhead only for WE Energy.



Please consult serving utility for their requirements prior to ordering or installing, as specifications and approvals vary by utility, and may require local electrical inspector approval. All installations must be installed by a licensed electrician and must comply with all national and local codes, laws and regulations. Milbank reserves the right to make changes in specifications and features shown without notice or obligation.

Lever Bypass Single Position Sockets

13

320 Amps | 4-5 Terminals | Ringless | 600V

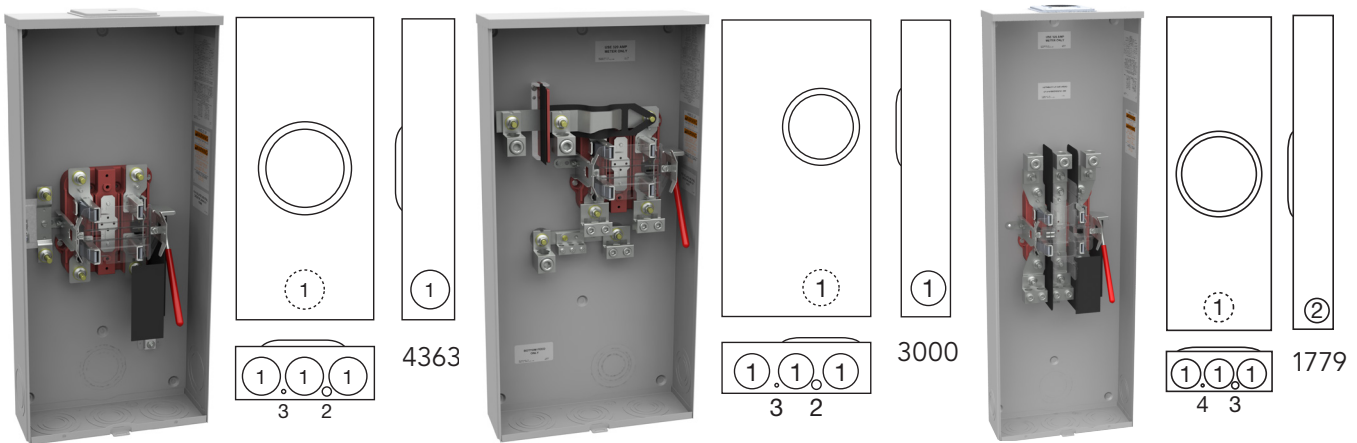

U4363-X-QG

U3000-O-K3L-K2L

U1779-RRL-5T9-K3-K2

320 Amps | 4-5 Terminals | Single Position | Lever Bypass | Ringless

Catalog Number	Terminals	Service	Hub	Connectors CU/AL		Dimensions			Knockouts				
				Line	Load	D"	W"	H"	1	2	3	4	
U1779-RRL-K3*	4	OH	H.O.	#4-600 kcmil (1) 1/0-250 kcmil (2)	3/8" x 16 Studs	4 ⁷ / ₈	13	38 ³ / ₄	3	2 ¹ / ₂	1/4, 1/2	1/4	—
U4363-X-QG	4	OH/UG	C.P.	3/8"x16 Studs	3/8" x 16 Studs	4 ⁷ / ₈	13	28 ¹ / ₄	3	1/4, 1/2	1/4	—	—
U3000-O-K3L	4	UG	Blank	#4-600 kcmil (1) 1/0-250 kcmil (2)	3/8" x 16 Studs	4 ⁷ / ₈	15	30	3	1/4, 1/2	1/4	—	—
U3000-O-K3L-K2L	4	UG	Blank	#4-600 kcmil (1) 1/0-250 kcmil (2)	(2) #6-350	4 ⁷ / ₈	15	30	3	1/4, 1/2	1/4	—	—
U1779-RRL-5T9-K3	5†	OH	H.O.	#4-600 kcmil (1) 1/0-250 kcmil (2)	3/8" x 16 Studs	4 ⁷ / ₈	13	38 ³ / ₄	3	2 ¹ / ₂	1/4, 1/2	1/4	—
U3000-O-5T9-K3L-K2L*	5†	UG	Blank	#4-600 kcmil (1) 1/0-250 kcmil (2)	(2) #6-350	4 ⁷ / ₈	15	30	3	1/4, 1/2	1/4	—	—

Notes

- **Hubs:** For proper hub selection, see the hub suffix chart on the accessories page.
 - **Bypass:** The lever supplies clamping action and operates bypass device.
 - **Fifth Terminal:** For field-installable fifth terminal, order catalog number **K3865**.
 - **Isolated Neutral:** For field-installable isolated neutral for **U3000**, order **K5978**. For the **U4363**, order **K5986**.
 - **Connectors:** Studded products are supplied with 3/8"-16 hex head nuts with Belleville washers. For connector lug kits for the **U1779**, order as extra **K1539L** (350 kcmil non-rotating), **K1540L** (600 kcmil non-rotating) or **K1350L** (twin 350 kcmil non-rotating). For **U3000**, order **K1350L** (350 kcmil non-rotating) or **K1540L** (600 kcmil non-rotating). For **U4363**, order **K1539** (350 kcmil), **K1540** (600 kcmil) or **K1350** (twin 350 kcmil). Note that **U4363** is UL-listed based on parallel 250 conductors only.
- *Includes factory-installed fifth terminal in the 9 o'clock position for use on Alliant Energy lines when a fifth terminal is required.
 †These units are rated 300 Amps continuous when used on Alliant Energy lines.

Please consult serving utility for their requirements prior to ordering or installing, as specifications and approvals vary by utility, and may require local electrical inspector approval. All installations must be installed by a licensed electrician and must comply with all national and local codes, laws and regulations. Milbank reserves the right to make changes in specifications and features shown without notice or obligation.



14

Lever Bypass Single Position Sockets

320 Amps | 7 Terminals | Ringless | 600V

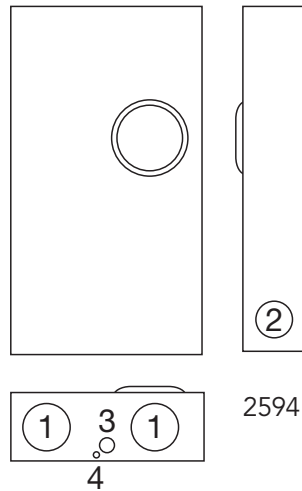
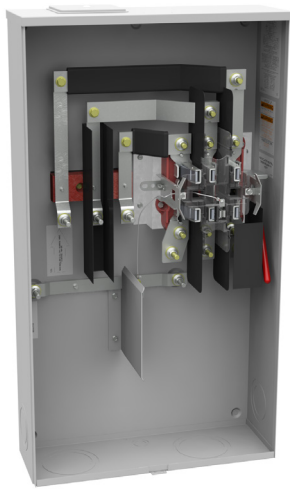

U2594-X

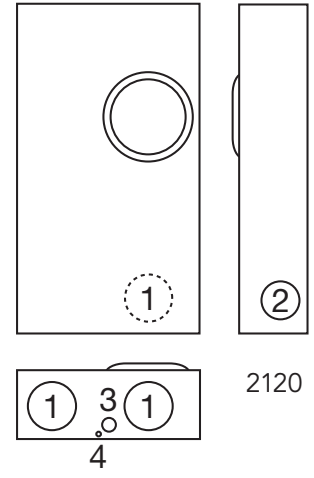

U2120-X

320 Amps* | 7 Terminals | Single Position | Heavy Duty Lever Bypass | Ringless

Catalog Number	Terminals	Service	Hub	Connectors CU/AL		Bypass	Dimensions			Knockouts			
				Line	Load		D"	W"	H"	1	2	3	4
U2594-X-K7	7	OH/UG	C.P.	#4-600 kcmil (1) 1/0-250 kcmil (2)	3/8"x16 Studs	Lever	6½	19	34⅛	4	3	1	¼
U2120-X-K7	7	UG	C.P.	#4-600 kcmil (1) 1/0-250 kcmil (2)	3/8"x16 Studs	Lever	6½	17¾	31¾	4	3	1	¼

Notes

- **Hubs:** For proper hub selection, see the hub suffix chart on the accessories page.
- **Bypass:** The lever supplies clamping action and operates bypass device.
- **Connectors:** Studded products are supplied with ⅜"-16 hex head nuts with Belleville washers. For connector lug kits, order as extra **K3082** (350 kcmil), **K3441** (600 kcmil) or **K3442** (twin 350 kcmil).
- **Isolated Neutral:** For field-installable isolated neutral, order **K5977**.

*These units are rated 300 Amps continuous when used on Alliant Energy lines.



Please consult serving utility for their requirements prior to ordering or installing, as specifications and approvals vary by utility, and may require local electrical inspector approval. All installations must be installed by a licensed electrician and must comply with all national and local codes, laws and regulations. Milbank reserves the right to make changes in specifications and features shown without notice or obligation.

Meter Mains

100–200 Amps | 4 Terminals | Ringless | 120/240V

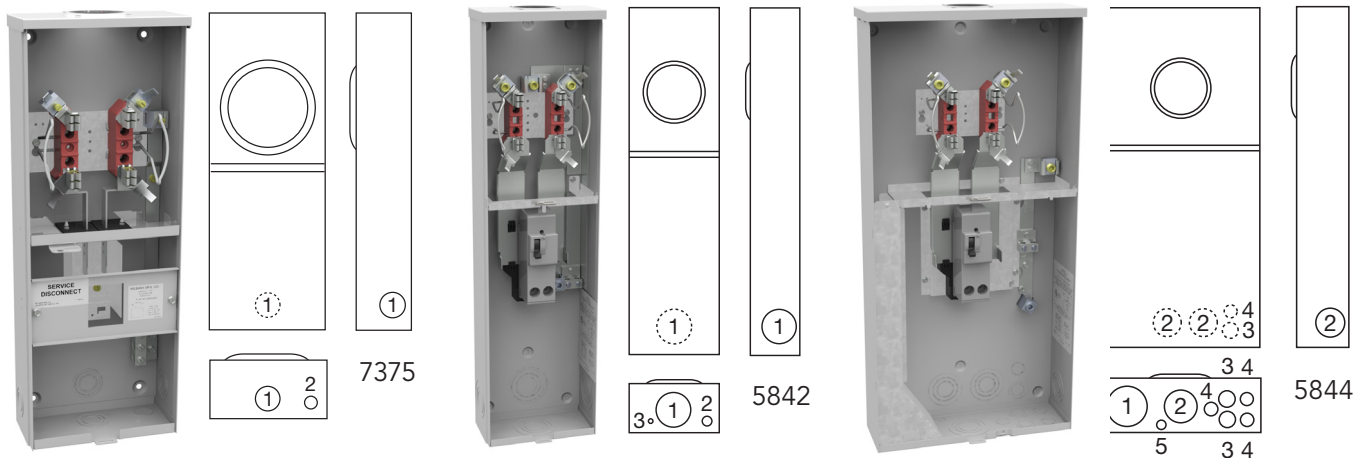

U7375-RL-KK

U5842-RL-200-KK

U5844-PXL-200-KK

*NEC 2020 Compliant

*NEC 2020 Compliant

100-200 Amps | 4 Terminals | Meter Mains | Horn Bypass | Ringless

Catalog Number	Service	Hub	Connectors CU/AL		Dimensions			Knockouts				
			Line	Load	D"	W"	H"	1	2	3	4	5
U7375-RL-KK	OH	C.P.	#6-2/0	CB	3¾	8⅞	22	1¼	¼, ½	—	—	—

100-200 Amps | 4 Terminals | Meter Mains | Horn Bypass | Ringless | **NEC 2023 Compliant**

Catalog Number	Service	Hub	Connectors CU/AL		Dimensions			Knockouts				
			Line	Load	D"	W"	H"	1	2	3	4	5
U5842-RL-100-KK*	OH	H.O.	#6-350	CB - 100A	4⅞	8	30	2½	¼, ½	¼	—	—
U5842-RL-200-KK*	OH	H.O.	#6-350	CB - 200A	4⅞	8	30	2½	¼, ½	¼	—	—
U5844-PXL-200-KK*	OH/UG	C.P.	#6-350	CB - 200A	4½	14	30	3	2½	1	½, ¾	¼, ½

Notes

- **Hub:** -PXL versions are supplied with one closing plate. Order other hubs separately.
- **Fifth Terminal:** For field-installable fifth terminal kit, order **K5T**.
- **Bypass:** The horn type bypass is factory-installed and permits changing and testing of the meter without interrupting customer service when used with utility-supplied jumpers.

*Models are rated 22K AIC when using Siemens **QPH** (100 Amps) or **QNH** (200 Amps) breakers.

Please consult serving utility for their requirements prior to ordering or installing, as specifications and approvals vary by utility, and may require local electrical inspector approval. All installations must be installed by a licensed electrician and must comply with all national and local codes, laws and regulations. Milbank reserves the right to make changes in specifications and features shown without notice or obligation.



Meter Mains with Load Center

200 Amps | 4 Terminals | Ringless | 120/240V

NEC 2023 Compliant

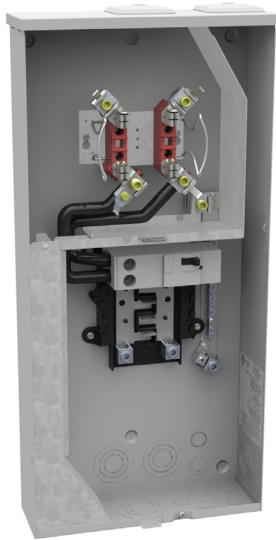

U5168-XTL-200-KK

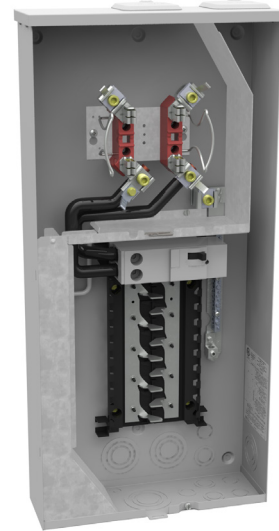
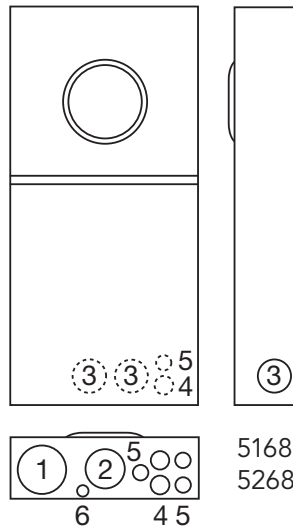

U5268-XTL-200-KK

200 Amps | 4 Terminals | Horn Bypass | Ringless | NEC 2023 Compliant

Catalog Number	Service	Hub	Connectors CU/AL – Line	Branch Circuits	Dimensions			Knockouts					
					D"	W"	H"	1	2	3	4	5	6
U5168-XTL-100-KK	OH/UG	C.P.	#6-350	10	4½	14⅞	30	3	2½	2	1	½,¾	¼,½
U5168-XTL-200-KK	OH/UG	C.P.	#6-350	8	4½	14⅞	30	3	2½	2	1	½,¾	¼,½
U5268-XTL-100-KK	OH/UG	C.P.	#6-350	20	4½	14⅞	30	3	2½	2	1	½,¾	¼,½
U5268-XTL-200-KK	OH/UG	C.P.	#6-350	20	4½	14⅞	30	3	2½	2	1	½,¾	¼,½

Notes

- **AIC Rating:** The **U5168** and **U5268** are rated 22K AIC when using Siemens **QPH** (100 Amps) or **QNH** (200 Amps) breakers.
- **Fifth Terminal:** For field-installable fifth terminal kit, order **K5T**.
- **Bypass:** The horn type bypass is factory-installed and permits changing and testing of the meter without interrupting customer service when used with utility-supplied jumpers.

Generator Interlock (compatible with U5168 and U5268)

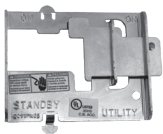

	K5815 Large QN with small frame Q	K5820 Large frame QN with large frame QN	K5830 Small frame Q to small frame Q
--	--	--	---



Please consult serving utility for their requirements prior to ordering or installing, as specifications and approvals vary by utility, and may require local electrical inspector approval. All installations must be installed by a licensed electrician and must comply with all national and local codes, laws and regulations. Milbank reserves the right to make changes in specifications and features shown without notice or obligation.

Cold Sequence Meter Mains

200 Amps | 7 Terminals | Ringless | 480V

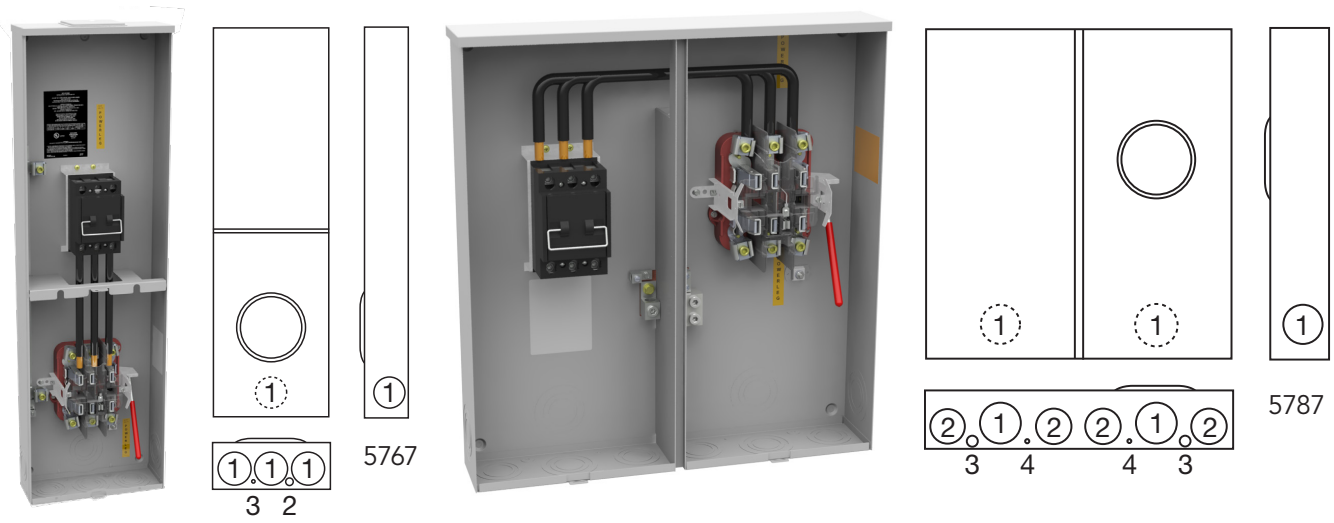

U5767-X-200-TF

U5787-O-200-TF

200 Amps | 7 Terminals | Lever Bypass | Ringless

Catalog Number	Terminals	Service	Hub	Connectors CU/AL	Dimensions			Knockouts			
				Line & Load	D"	W"	H"	1	2	3	4
U5767-X-200-TF	7	OH/UG	C.P.	#6-350	4 ²⁷ / ₃₂	13	43	3	1/4, 1/2	1/4	—
U5767-X-200-CB	7	OH/UG	C.P.	#6-350	4 ²⁷ / ₃₂	13	43	4	2 1/2	1	1/2, 3/4
U5787-O-200-TF	7	UG	Blank	#6-350	4 ²⁷ / ₃₂	26	28	4	1/2, 3/4	1	1/2, 3/4
U5767-O-200-CB	7	UG	Blank	#6-350	4 ²⁷ / ₃₂	13	43	4	2 1/2	1	1/2, 3/4

Notes

- **Hubs:** For proper hub selection, refer to the hub suffix chart on the accessories page.
- **Fuse Pullouts:** Fuse pullout disconnects ahead of meter socket. Use class T fuses.
- **Bypass:** The lever supplies clamping action and operates bypass device.

Please consult serving utility for their requirements prior to ordering or installing, as specifications and approvals vary by utility, and may require local electrical inspector approval. All installations must be installed by a licensed electrician and must comply with all national and local codes, laws and regulations. Milbank reserves the right to make changes in specifications and features shown without notice or obligation.



100 Amps | 4 Terminals | Ringless | 300V

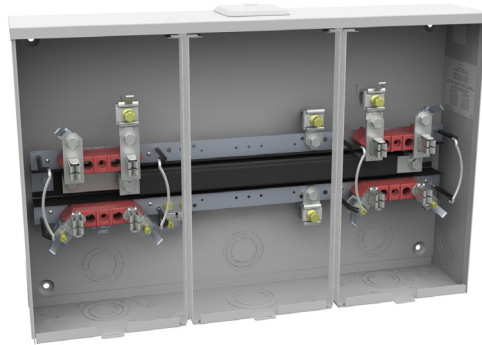

U8032-XL-KK

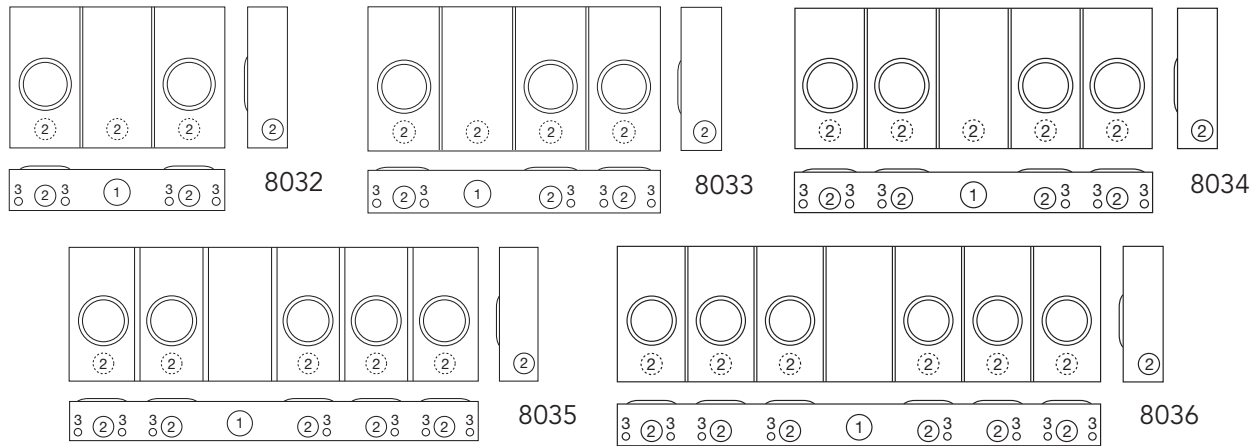

100 Amps per Position | 4 Terminals | Multi-Position | Center Wireway | Horn Bypass | Ringless

Catalog Number	Positions	Service	Hub	Connectors CU/AL		Dimensions			Knockouts		
				Line	Load	D"	W"	H"	1	2	3
U8032-XL-KK	2	OH/UG*	C.P.	#6-350	#6-2/0	4½	24½	16	2½	2	½
U8033-XL-KK	3	OH/UG*	C.P.	#6-350	#6-2/0	4½	32 ¹¹ / ₁₆	16	2½	2	½
U8034-XL-KK	4	OH/UG*	C.P.	#6-350	#6-2/0	4½	40 ⁷ / ₈	16	2½	2	½
U8035-XL-KK	5	OH/UG*	C.P.	#6-350	#6-2/0	4½	49 ¹ / ₁₆	16	2½	2	½
U8036-XL-KK	6	OH/UG*	C.P.	#6-350	#6-2/0	4½	57¼	16	2½	2	½

Notes

- **Fifth Terminal:** For field-installable fifth terminal, order catalog number **5T8K2** For the 6 o'clock position. Order **K9959** for the 9 o'clock position. Only the **U8032-XL-KK** is Alliant approved for fifth terminal use (**U8032-XL-KK-5T9**).
 - **Connectors:** Extruded aluminum connectors are tin plated.
 - **Bypass:** The horn bypass is factory-installed and permits changing and testing of the meter without interrupting customer service when used with utility-supplied jumpers.
- *Models are approved for WE Energy overhead service only.



Please consult serving utility for their requirements prior to ordering or installing, as specifications and approvals vary by utility, and may require local electrical inspector approval. All installations must be installed by a licensed electrician and must comply with all national and local codes, laws and regulations. Milbank reserves the right to make changes in specifications and features shown without notice or obligation.

Multi-Position Sockets

100 Amps | 4 Terminals | Ringless | 300V

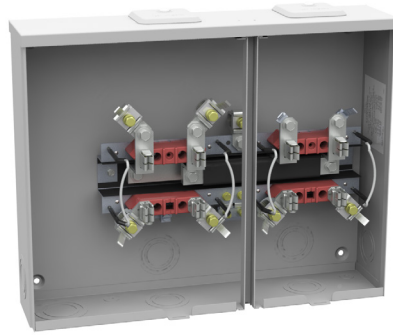

L572-XL-KK

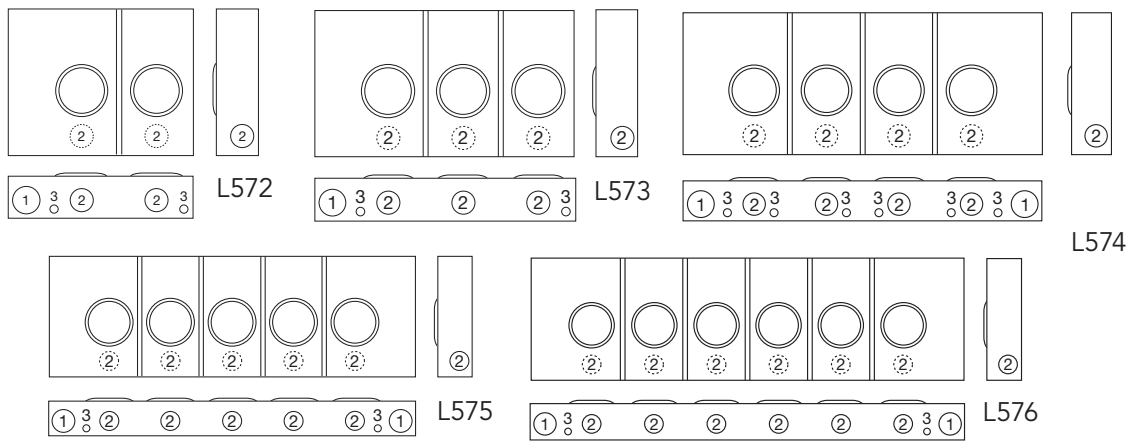

100 Amps per Position | 4 Terminals | Multi-Position | Side Wireway | Horn Bypass | Ringless

Catalog Number	Positions	Service	Hub	Connectors CU/AL		Dimensions			Knockouts		
				Line	Load	D"	W"	H"	1	2	3
L572-XL-KK	2	OH/UG	C.P.	#6-350	#6-2/0	4½	20 ⁵ / ₁₆	16	2½	2	¼, ½
L573-XL-KK	3	OH/UG	C.P.	#6-350	#6-2/0	4½	28½	16	2½	2	¼, ½
L574-XL-KK*	4	OH/UG	C.P.	#6-350	#6-2/0	4½	40 ⁵ / ₁₆	16	2½	2	¼, ½
L575-XL-KK*	5	OH/UG	C.P.	#6-350	#6-2/0	4½	48 ⁷ / ₈	16	2½	2	¼, ½
L576-XL-KK*	6	OH/UG	C.P.	#6-350	#6-2/0	4½	57 ¹ / ₁₆	16	2½	2	¼, ½

Notes

- **Hubs:** For proper hub selection, refer to the hub suffix chart on the accessories page.
- **Fifth Terminal:** For field-installable fifth terminal, order catalog number **5T8K2** for the 6 o'clock position and **K9959** for the 9 o'clock position.
- **Connectors:** Extruded aluminum connectors are tin plated.
- **Bypass:** The horn bypass is factory-installed and permits changing and testing of the meter without interrupting customer service when used with utility-supplied jumpers.

*Models are approved for Alliant Energy with overhead service only.

Please consult serving utility for their requirements prior to ordering or installing, as specifications and approvals vary by utility, and may require local electrical inspector approval. All installations must be installed by a licensed electrician and must comply with all national and local codes, laws and regulations. Milbank reserves the right to make changes in specifications and features shown without notice or obligation.





U7363-RL-KK

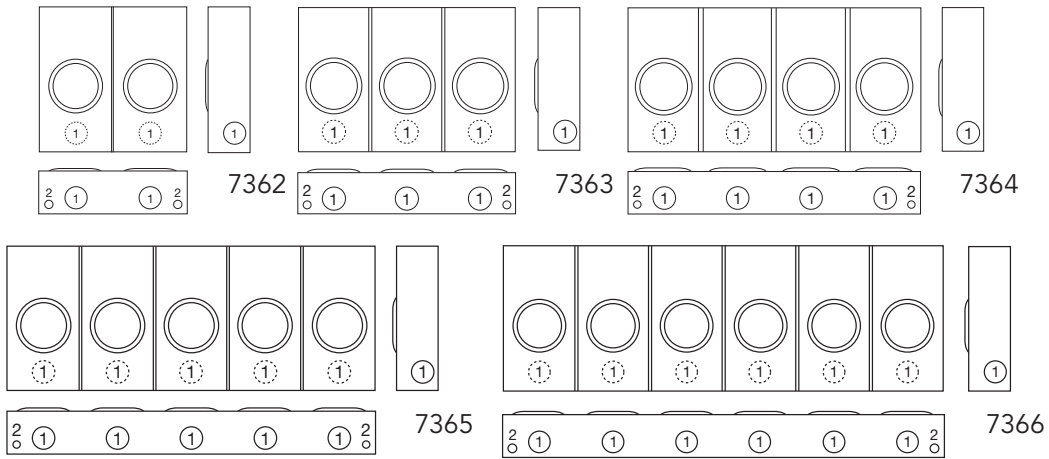

100 Amps per Position | 4 Terminals | Multi-Position | Horn Bypass | Ringless

Catalog Number	Positions	Service	Hub	Connectors CU/AL		Dimensions			Knockouts	
				Line	Load	D"	W"	H"	1	2
U7362-RL-KK	2	OH	H.O.	#6-350	#6-2/0	4½	16 ⁵ / ₁₆	16	2½	¼, ½
U7363-RL-KK	3	OH	H.O.	#6-350	#6-2/0	4½	24½	16	2½	¼, ½
U7364-RL-KK	4	OH	H.O.	#6-350	#6-2/0	4½	32 ¹¹ / ₁₆	16	2½	¼, ½
U7365-RL-KK	5	OH	H.O.	#6-350	#6-2/0	4½	40 ⁷ / ₈	16	2½	¼, ½
U7366-RL-KK	6	OH	H.O.	#6-350	#6-2/0	4½	49 ¹ / ₁₆	16	2½	¼, ½

Notes

- **Hubs:** For proper hub selection, refer to the hub suffix chart on the accessories page.
- **Fifth Terminal:** For field-installable fifth terminal, order catalog number **5T8K2** for the 6 o'clock position and **K9959** for the 9 o'clock position.
- **Connectors:** Extruded aluminum connectors are tin plated.
- **Bypass:** The horn bypass is factory-installed and permits changing and testing of the meter without interrupting customer service when used with utility-supplied jumpers.



Please consult serving utility for their requirements prior to ordering or installing, as specifications and approvals vary by utility, and may require local electrical inspector approval. All installations must be installed by a licensed electrician and must comply with all national and local codes, laws and regulations. Milbank reserves the right to make changes in specifications and features shown without notice or obligation.

Multi-Position Sockets

100 Amps | 4 Terminals | Ringless | 300V



U2692-XL-KK

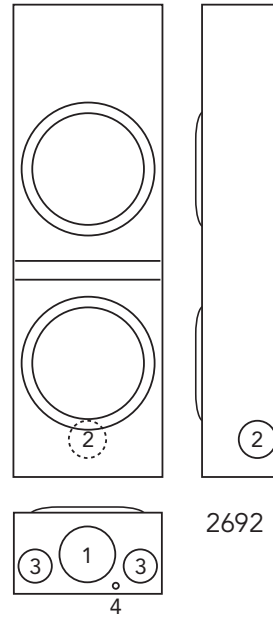

2692

100 Amps per Position | 4 Terminals | Multi-Position | Horn Bypass | Ringless

Catalog Number	Positions	Service	Hub	Connectors CU/AL		Bypass	Dimensions			Knockouts			
				Line	Load		D"	W"	H"	1	2	3	4
U2692-XL-KK	2	OH	C.P.	#2-350	#6-2/0	Horn	4 1/8	8	25 1/4	2 1/2	1 1/2	1 1/4	1/4

Notes

- **Hubs:** For proper hub selection, refer to the hub suffix chart on the accessories page.
- **Fifth Terminal:** For field-installable fifth terminal, order catalog number **5T8K2** for the 9 o'clock position.
- **Connectors:** Extruded aluminum connectors are tin plated.
- **Bypass:** The horn bypass is factory-installed and permits changing and testing of the meter without interrupting customer service when used with utility-supplied jumpers.

Please consult serving utility for their requirements prior to ordering or installing, as specifications and approvals vary by utility, and may require local electrical inspector approval. All installations must be installed by a licensed electrician and must comply with all national and local codes, laws and regulations. Milbank reserves the right to make changes in specifications and features shown without notice or obligation.





U1252-X-KK-K1-PED
(shown without pedestal)

200 Amps per Position | 4 Terminals | Multi-Position | Horn Bypass | Ringless

Catalog Number	Positions	Service	Hub	Connectors CU/AL		Bypass	Dimensions		
				Line	Load		D"	W"	H"
U1252-X-KK	2	OH	C.P.	3/8" x 16 Studs	#6-350	Horn	5 1/8	26 1/2	14
U1253-X-KK	3	OH	C.P.	3/8" x 16 Studs	#6-350	Horn	5 1/8	34 3/4	14
U1254-X-KK	4	OH	C.P.	3/8" x 16 Studs	#6-350	Horn	5 1/8	42 7/8	16
U1252-X-KK-K1-PED	2	UG*	C.P.	#6-350	#6-350	Horn	5 1/8	26 1/2	14
U1253-X-KK-K3-PED	3	UG*	C.P.	#4-600	#6-350	Horn	5 1/8	34 3/4	14
U1254-X-KK-K3-PED	4	UG*	C.P.	#4-600	#6-350	Horn	5 1/8	42 7/8	16
U1255-X-KK-K4-PED	5	UG*	C.P.	(2) #2-600	#6-350	Horn	5 1/8	54 1/2	16
U1256-X-KK-PED	6	UG*	C.P.	3/8" x 16 Studs	#6-350	Horn	5 1/8	63 1/16	18

Notes

- **Knockouts:** See next page for knockout configuration information.
- **Hubs:** For proper hub selection, refer to the hub suffix chart on the accessories page. Two hub openings are supplied (5 and 6 position units only) and the extra opening is closed with a closing plate as standard. To use a hub smaller than 3 inches, the **S8324** adapter is required.
- **Fifth Terminal:** For field-installable fifth terminal, order catalog number **K5T** (9 o'clock position).
- **Connectors:** Units supplied with 3/8" -16 hex head nuts with Belleville washers on line side. Order connector kits **K1539** (350 kcmil), **K1540** (600 kcmil) or **K1541** (twin 600 kcmil).
- **Bypass:** The horn bypass is factory-installed and permits changing and testing of the meter without interrupting customer service when used with utility-supplied jumpers.

*For underground service, order the **S2291-TO** pedestal raceway. A 12-inch pedestal extension kit is also available — order catalog number **S2571**.



Please consult serving utility for their requirements prior to ordering or installing, as specifications and approvals vary by utility, and may require local electrical inspector approval. All installations must be installed by a licensed electrician and must comply with all national and local codes, laws and regulations. Milbank reserves the right to make changes in specifications and features shown without notice or obligation.

Multi-Position Sockets

U1252 Series | Knockout Information

Knockouts (Non-Pedestal Units)				
1	2	3	4	5
3	2½	1	½	¼

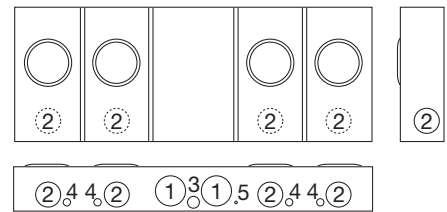
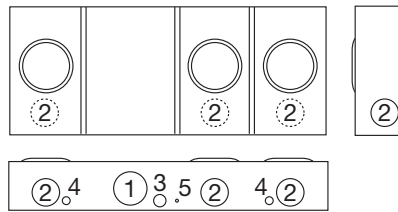
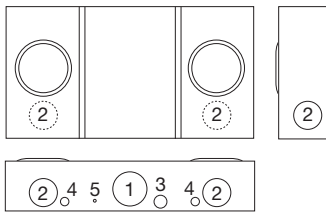

Knockouts (Pedestal Units)
1
2½

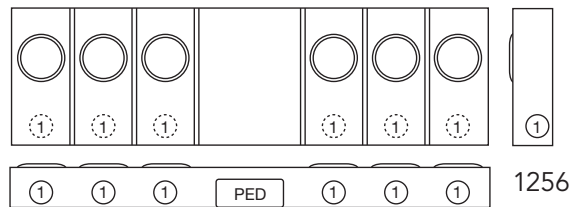
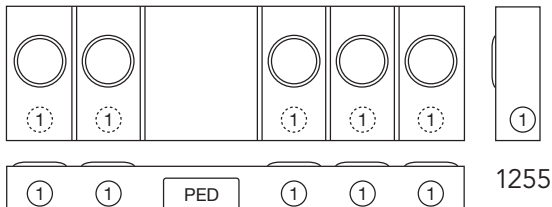
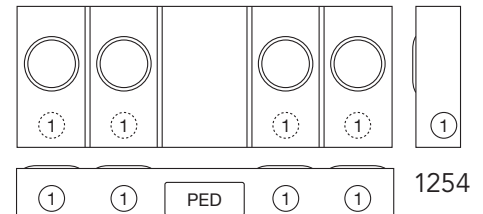
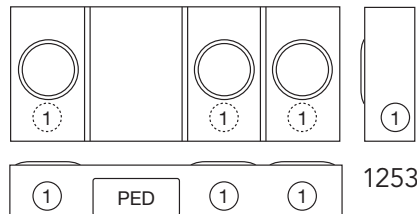
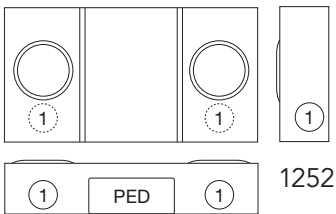

Please consult serving utility for their requirements prior to ordering or installing, as specifications and approvals vary by utility, and may require local electrical inspector approval. All installations must be installed by a licensed electrician and must comply with all national and local codes, laws and regulations. Milbank reserves the right to make changes in specifications and features shown without notice or obligation.



Lever Bypass Multi-Position Sockets

200 Amps | 5 Terminals | Ringless | 600V

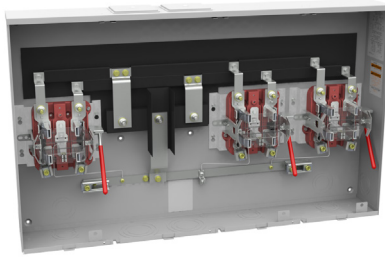

U2873-XT

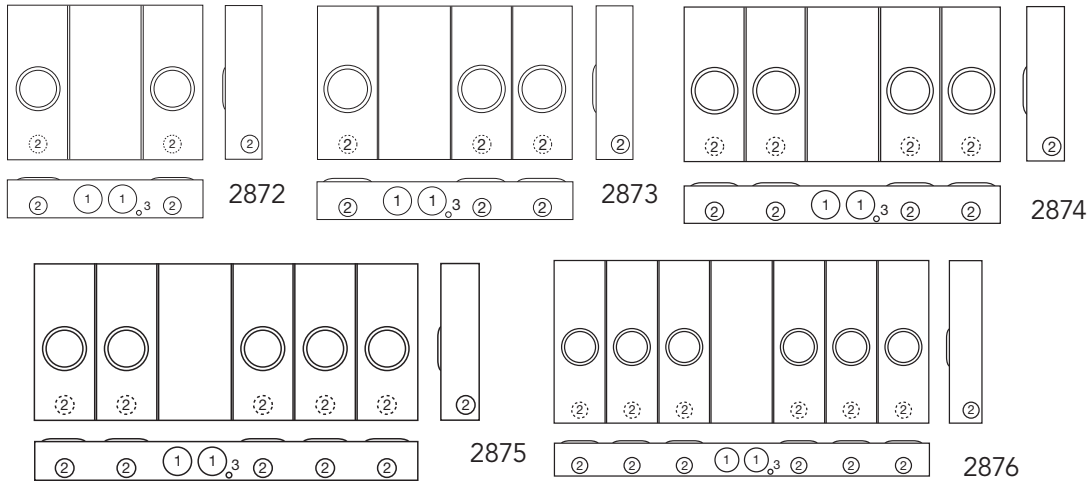

200 Amps per Position | 5 Terminals | Multi-Position | Lever Bypass | Ringless

Catalog Number	Positions	Service	Hub	Connectors CU/AL		Dimensions			Knockouts		
				Line	Load	D"	W"	H"	1	2	3
U2872-XT	2	OH	(2) C.P.	3/8" x 16 Studs	#6-350	6	32 ¹ / ₈	25 ¹ / ₄	4	2 ¹ / ₂	1 ¹ / ₄ , 1 ¹ / ₂
U2872-XT-K3	2	OH	(2) C.P.	#4-600	#6-350	6	32 ¹ / ₈	25 ¹ / ₄	4	2 ¹ / ₂	1 ¹ / ₄ , 1 ¹ / ₂
U2872-XT-5T9-K3	2	OH	(2) C.P.	#4-600	#6-350	6	32 ¹ / ₈	25 ¹ / ₄	4	2 ¹ / ₂	1 ¹ / ₄ , 1 ¹ / ₂
U2873-XT	3	OH	(2) C.P.	3/8" x 16 Studs	#6-350	6	42 ³ / ₁₆	25 ¹ / ₄	4	2 ¹ / ₂	1 ¹ / ₄ , 1 ¹ / ₂
U2873-XT-K3	3	OH	(2) C.P.	#4-600	#6-350	6	42 ³ / ₁₆	25 ¹ / ₄	4	2 ¹ / ₂	1 ¹ / ₄ , 1 ¹ / ₂
U2874-XT	4	OH	(2) C.P.	3/8" x 16 Studs	#6-350	6	52 ¹ / ₄	25 ¹ / ₄	4	2 ¹ / ₂	1 ¹ / ₄ , 1 ¹ / ₂
U2874-XT-K3	4	OH	(2) C.P.	#4-600	#6-350	6	52 ¹ / ₄	25 ¹ / ₄	4	2 ¹ / ₂	1 ¹ / ₄ , 1 ¹ / ₂

Notes

- **Connectors:** Units supplied with 3/8"-16 hex head nuts with Belleville washers on line side. Order connector kits **K1539** (350 kcmil), **K1540** (600 kcmil), **K1350** (twin 350 kcmil) or **K1541** (twin 600 kcmil).
- **Bypass:** The lever operates bypass device and supplies clamping action to meter spades.
- **Fifth Terminal:** Fifth terminal is in 6 o'clock position unless part number includes **-5T9**, which is in the 9 o'clock position.
- **MGE Applications:** Contact Madison Gas and Electric for approval and mounting instructions.



Please consult serving utility for their requirements prior to ordering or installing, as specifications and approvals vary by utility, and may require local electrical inspector approval. All installations must be installed by a licensed electrician and must comply with all national and local codes, laws and regulations. Milbank reserves the right to make changes in specifications and features shown without notice or obligation.

Lever Bypass Multi-Position Sockets

25

200 Amps | 7 Terminals | Ringless | 600V

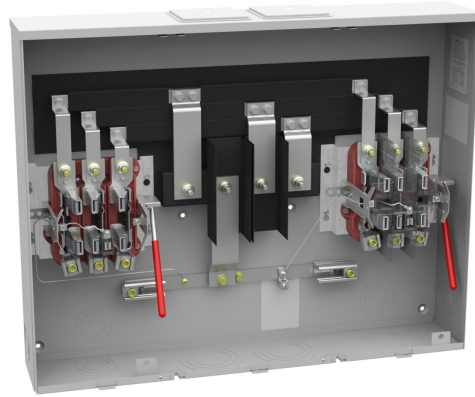

U2732-XT-PED
(shown without pedestal)

200 Amps per Position | 7 Terminals | Multi-Position | Lever Bypass | Ringless

Catalog Number	Positions	Service	Hub	Connectors CU/AL		Bypass	Dimensions		
				Line	Load		D"	W"	H"
U2732-XT-PED	2	OH/UG	(2) C.P.	3/8" x 16 Studs	#6-350	Lever	6	32 ¹ / ₈	25 ¹ / ₄
U2732-XT-PED-K7	2	OH/UG	(2) C.P.	#4-600	#6-350	Lever	6	32 ¹ / ₈	25 ¹ / ₄
U2733-XT-PED	3	OH/UG	(2) C.P.	3/8" x 16 Studs	#6-350	Lever	6	42 ³ / ₁₆	25 ¹ / ₄
U2733-XT-PED-K7	3	OH/UG	(2) C.P.	#4-600	#6-350	Lever	6	42 ³ / ₁₆	25 ¹ / ₄
U2734-XT-PED	4	OH/UG	(2) C.P.	3/8" x 16 Studs	#6-350	Lever	6	52 ¹ / ₄	25 ¹ / ₄
U2734-XT-PED-K7	4	OH/UG	(2) C.P.	#4-600	#6-350	Lever	6	52 ¹ / ₄	25 ¹ / ₄
U2735-XT-PED	5	OH/UG	(2) C.P.	3/8" x 16 Studs	#6-350	Lever	6	62 ⁵ / ₁₆	25 ¹ / ₄
U2735-XT-PED-K7	5	OH/UG	(2) C.P.	#4-600	#6-350	Lever	6	62 ⁵ / ₁₆	25 ¹ / ₄
U2736-XT-PED	6	OH/UG	(2) C.P.	3/8" x 16 Studs	#6-350	Lever	6	72 ³ / ₈	31 ¹ / ₄
U2736-XT-PED-K7	6	OH/UG	(2) C.P.	#4-600	#6-350	Lever	6	72 ³ / ₈	31 ¹ / ₄

Notes

- **Knockouts:** See next page for knockout configuration information.
- **Hubs:** Units supplied with two closing plates. To order extra, refer to the hub suffix chart on the accessories page.
- **Connector Kits:** For line side connector kits, order **K3082** (350 kcmil), **K3441** (600 kcmil), **K3442** (twin 350 kcmil) or **K3083** (twin 600 kcmil). Line connectors can be reversed to change from overhead to underground service.
- **Bypass:** The lever operates bypass device and supplies clamping action to meter spades.
- **Underground Applications:** For underground service, order the **S2291-TO** raceway. A 12-inch pedestal extension kit is also available—order catalog number **S2571**.
- **MGE Applications:** Contact Madison Gas and Electric for approval and mounting instructions.

Please consult serving utility for their requirements prior to ordering or installing, as specifications and approvals vary by utility, and may require local electrical inspector approval. All installations must be installed by a licensed electrician and must comply with all national and local codes, laws and regulations. Milbank reserves the right to make changes in specifications and features shown without notice or obligation.



Lever Bypass Multi-Position Sockets

U2732 Series | Knockout Information

Knockouts	
1	2
2½	¼, ½

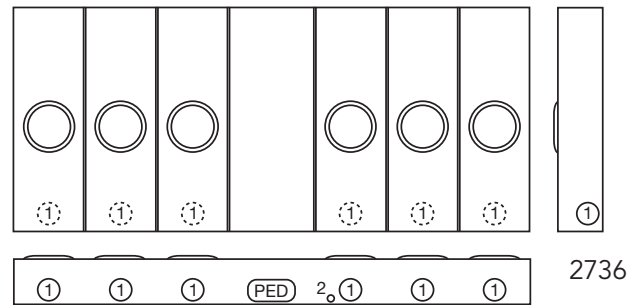
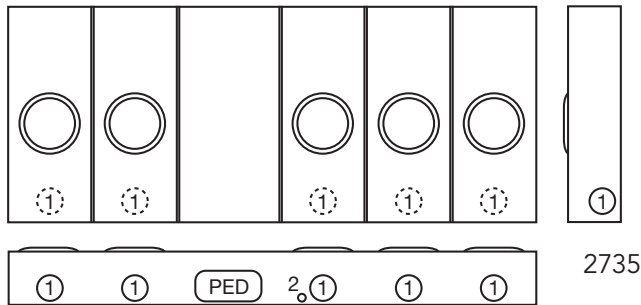
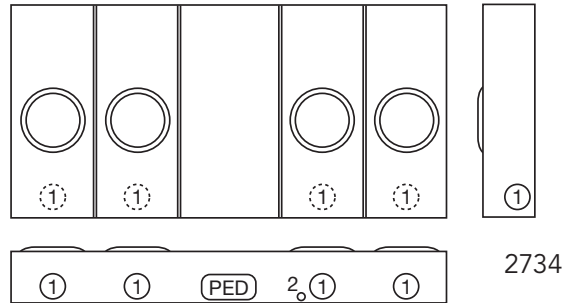
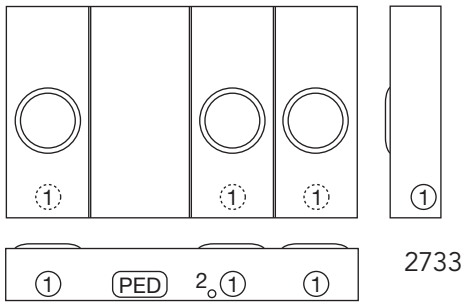
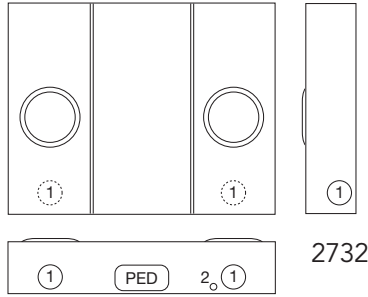

Please consult serving utility for their requirements prior to ordering or installing, as specifications and approvals vary by utility, and may require local electrical inspector approval. All installations must be installed by a licensed electrician and must comply with all national and local codes, laws and regulations. Milbank reserves the right to make changes in specifications and features shown without notice or obligation.

Multi-Position Meter Mains

125-200 Amps | 4 Terminals | Ringless | 120/240V

NEC 2023 Compliant



U5882-X-KK-K1



U5884-X-KK-K1

125-200 Amps per Position | 4 Terminals | Multi-Position Meter Mains | Horn Bypass | Ringless

Catalog Number	Amps	Positions	Service	Hub	Weight (lbs.)	Connectors CU/AL		Dimensions		
						Line	Load	D"	W"	H"
U5902-X-KK-K1-PED	125	2	OH/UG	C.P.	58	1/0-350	#6-350	5 $\frac{1}{8}$ "	26 $\frac{1}{2}$ "	30
U5903-X-KK-K1-PED	125	3	OH/UG	C.P.	88	1/0-350	#6-350	5 $\frac{1}{8}$ "	34 $\frac{5}{8}$ "	30
U5904-X-KK-K1-PED	125	4	OH/UG	C.P.	107	1/0-350	#6-350	5 $\frac{1}{8}$ "	42 $\frac{1}{2}$ "	30
U5905-X-KK-K1-PED	125	5	OH/UG	C.P.	128	1/0-350	#6-350	5 $\frac{1}{8}$ "	51 $\frac{1}{20}$ "	30
U5906-X-KK-K1-PED	125	6	OH/UG	C.P.	146	1/0-350	#6-350	5 $\frac{1}{8}$ "	59 $\frac{3}{10}$ "	30
U5882-X-KK-K1-PED	200	2	OH/UG	C.P.	58	1/0-350	#6-350	5 $\frac{1}{8}$ "	26 $\frac{1}{2}$ "	30
U5883-X-KK-K1-PED	200	3	OH/UG	C.P.	88	1/0-350	#6-350	5 $\frac{1}{8}$ "	34 $\frac{5}{8}$ "	30
U5884-X-KK-K1-PED	200	4	OH/UG	C.P.	107	1/0-350	#6-350	5 $\frac{1}{8}$ "	42 $\frac{1}{2}$ "	30
U5885-X-KK-K1-PED	200	5	OH/UG	C.P.	128	1/0-350	#6-350	5 $\frac{1}{8}$ "	51 $\frac{1}{20}$ "	30
U5886-X-KK-K1-PED	200	6	OH/UG	C.P.	146	1/0-350	#6-350	5 $\frac{1}{8}$ "	59 $\frac{3}{10}$ "	30

Notes

- **Alliant Energy Use:** For use on Alliant Energy lines, omit the **-PED** from the catalog number.
- **Knockouts:** See next page for knockout configuration information.
- **AIC Rating:** All models are rated 22K AIC when used with approved breakers rated at 22K.
- **Hubs:** Units supplied with one closing plate. To order hubs separately, see the accessories section.
- **Fifth Terminal:** For field-installable fifth terminal, order **K5T**.
- **Underground Applications:** Order the **S2291-TO** pedestal raceway.

Breaker Chart - 10K AIC (unless noted 22K)

Manufacturer	Cutler-Hammer	Siemens	GE (50 Amp Max)	Square D
125 Amps or Less	BR, HQP, QPGF	QP, QPH (22K)	THQL, THQL-GF	Homeline
150-200 Amps	BR, BJ	QN, QNH (22K)	—	—

Please consult serving utility for their requirements prior to ordering or installing, as specifications and approvals vary by utility, and may require local electrical inspector approval. All installations must be installed by a licensed electrician and must comply with all national and local codes, laws and regulations. Milbank reserves the right to make changes in specifications and features shown without notice or obligation.



Multi-Position Meter Mains

U5882 and U5902 Series | Knockout Information

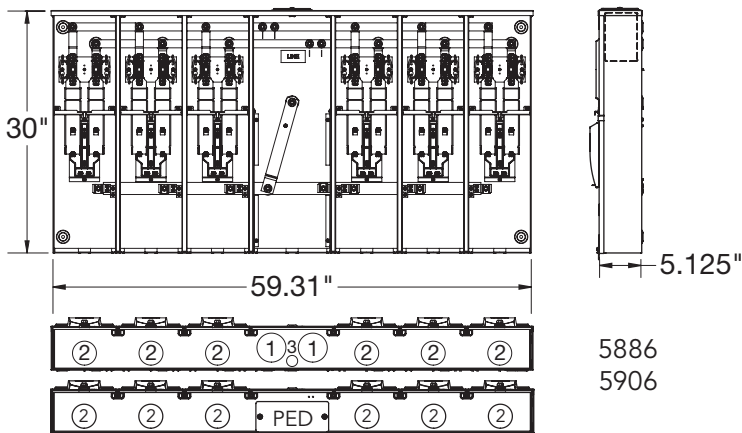
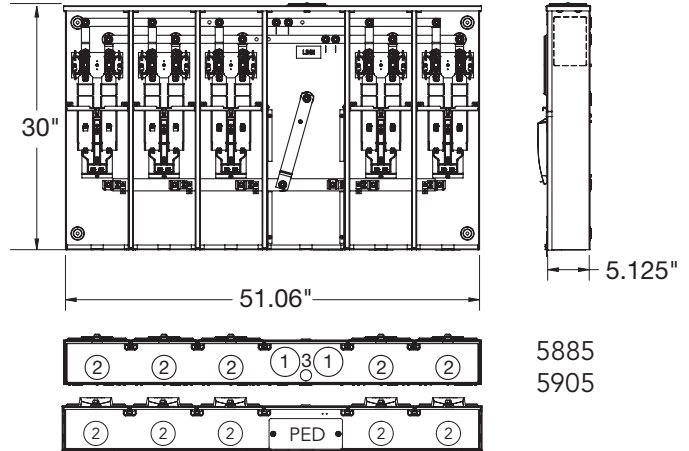
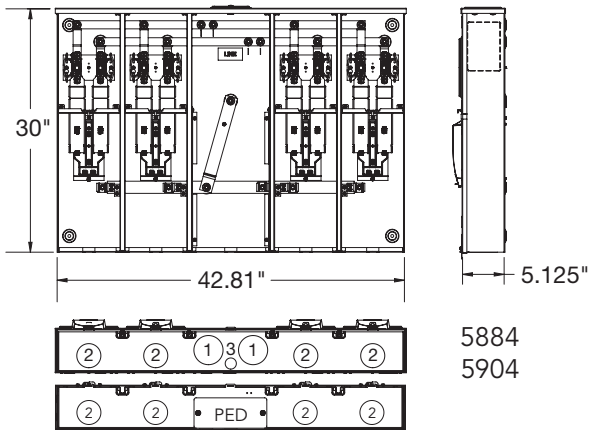
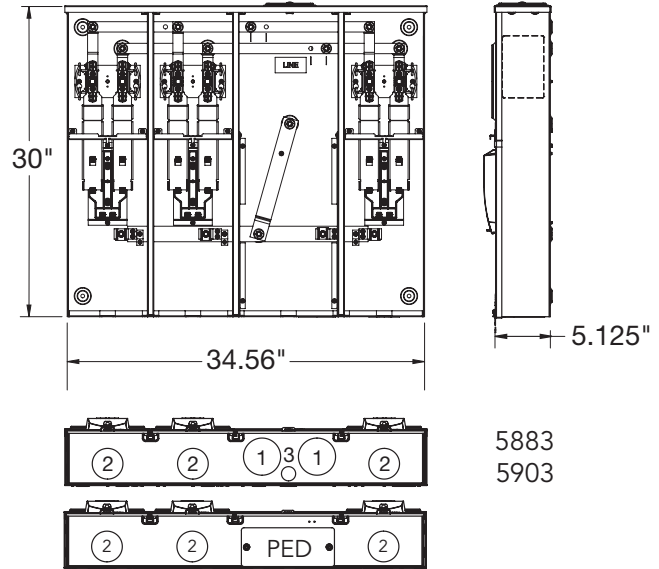
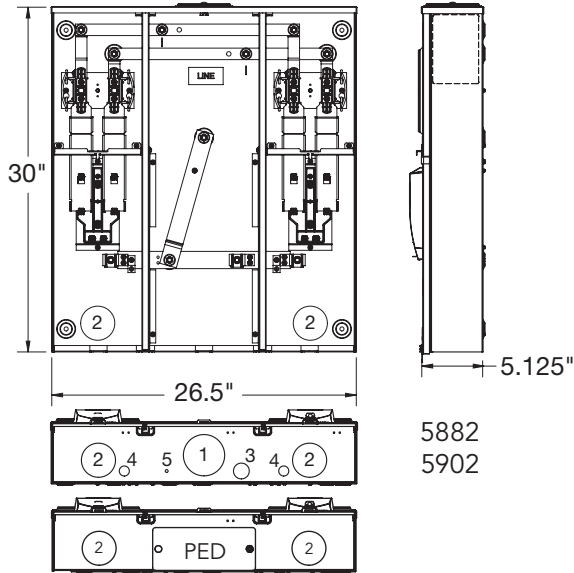

Knockouts				
1	2	3	4	5
3	2 1/2	1	7/8	1/4



Please consult serving utility for their requirements prior to ordering or installing, as specifications and approvals vary by utility, and may require local electrical inspector approval. All installations must be installed by a licensed electrician and must comply with all national and local codes, laws and regulations. Milbank reserves the right to make changes in specifications and features shown without notice or obligation.

Transformer Rated Meter Sockets

20 Amps | 5–13 Terminals | Ringless



UC7448-XL

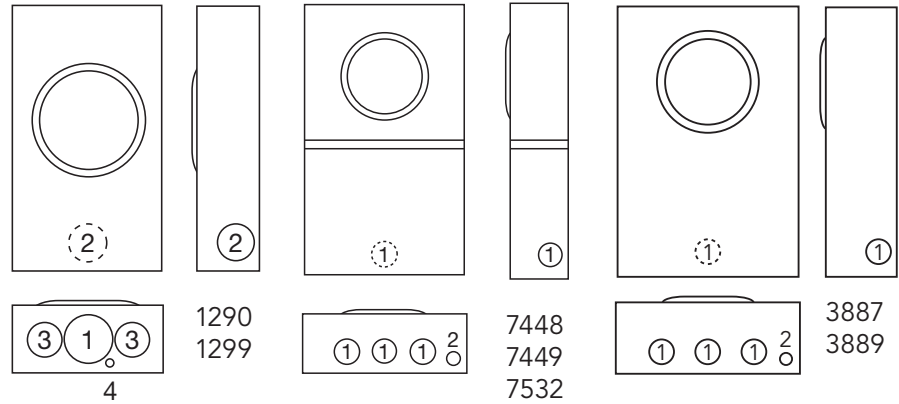

20 Amps | Transformer Rated Meter Sockets | Ringless

Catalog Number	Terminals	Meter Form	Cover	Service	Hub	Connectors CU	Bypass	Dimensions			Knockouts			
								D"	W"	H"	1	2	3	4
UC1290-RL*	5	3S	1-Piece	OH/UG	H.O.	#14-2 Max	Plunger	3 ⁵ / ₁₆	8	14	2	1 ¹ / ₂	1 ¹ / ₄	1 ¹ / ₄
UC1299-RL*	6	4S	1-Piece	OH/UG	H.O.	#14-2 Max	Plunger	3 ⁵ / ₁₆	8	14	2	1 ¹ / ₂	1 ¹ / ₄	1 ¹ / ₄
UC7532-XL	6	4S	2-Piece	OH/UG	C.P.	#14-2 Max	None	4 ¹ / ₈	12	20	1 ¹ / ₄	1 ¹ / ₄ , 1 ¹ / ₂	—	—
UC7448-XL	8	5S	2-Piece	OH/UG	C.P.	#14-2 Max	None	4 ¹ / ₈	12	20	1 ¹ / ₄	1 ¹ / ₄ , 1 ¹ / ₂	—	—
UC3887-XL	8	5S	1-Piece	OH/UG	C.P.	#14-2 Max	None	5	13	19	1 ¹ / ₄	1 ¹ / ₄ , 1 ¹ / ₂	—	—
UC7449-XL	13	6, 8, 9 & (ALT) 10S	2-Piece	OH/UG	C.P.	#14-2 Max	None	4 ¹ / ₈	12	20	1 ¹ / ₄	1 ¹ / ₄ , 1 ¹ / ₂	—	—
UC3889-XL	13	6, 8, 9 & (ALT) 10S	1-Piece	OH/UG	C.P.	#14-2 Max	None	5	13	19	1 ¹ / ₄	1 ¹ / ₄ , 1 ¹ / ₂	—	—

Notes

- **Hubs:** For proper hub selection, see the hub suffix chart in the accessories section.
- **Prewiring:** If factory prewiring is required, specify on order. Be sure to include the meter socket catalog number, test switch model and number, and meter form number. Please be sure to provide a copy of your wiring diagram.
- **Utility Approval:** For utility approval information, see the utility approvals page.

*These units do not have a test switch provision.

Please consult serving utility for their requirements prior to ordering or installing, as specifications and approvals vary by utility, and may require local electrical inspector approval. All installations must be installed by a licensed electrician and must comply with all national and local codes, laws and regulations. Milbank reserves the right to make changes in specifications and features shown without notice or obligation.



Multi-Position Transformer Rated

20 Amps | 8-13 Terminals | Ring Type

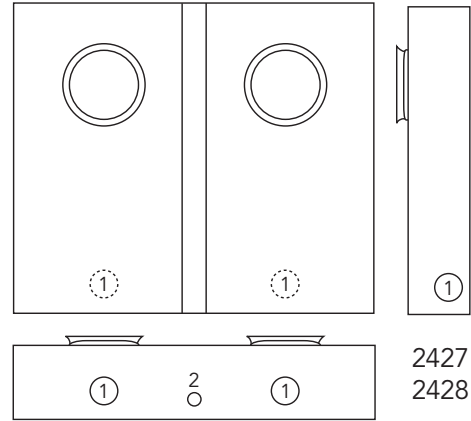
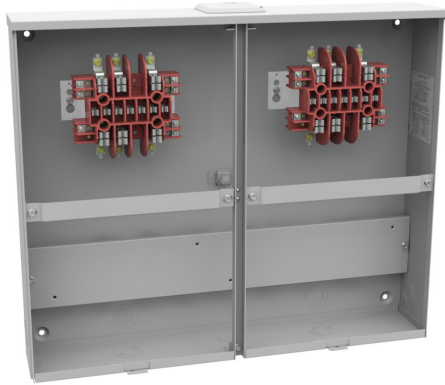

UC2428-XL

20 Amps | Multi-Position Transformer Rated Meter Sockets | Ring Type

Catalog Number	Terminals	Meter Form	Cover	Service	Hub	Connectors CU	Bypass	Dimensions			Knockouts	
								D"	W"	H"	1	2
UC2427-XL	8	5S	2-Piece	OH/UG	C.P.	#14-2 Max	None	4 ¹ / ₈	24 ¹ / ₁₆	20	1 ¹ / ₄	1 ¹ / ₄ , 1 ¹ / ₂
UC2428-XL	13	6, 8, 9 & (ALT) 10S	2-Piece	OH/UG	C.P.	#14-2 Max	None	4 ¹ / ₈	24 ¹ / ₁₆	20	1 ¹ / ₄	1 ¹ / ₄ , 1 ¹ / ₂

Notes

- **Sealing Rings:** These units are supplied with two **MR-4** screw type sealing rings.
- **Hubs:** For proper hub selection, see the hub suffix chart in the accessories section.
- **Prewiring:** If factory prewiring is required, specify on order. Be sure to include the meter socket catalog number, test switch model and number, and meter form number. Please be sure to provide a copy of your wiring diagram.
- **Utility Approval:** For utility approval information see pages 67-69.



Please consult serving utility for their requirements prior to ordering or installing, as specifications and approvals vary by utility, and may require local electrical inspector approval. All installations must be installed by a licensed electrician and must comply with all national and local codes, laws and regulations. Milbank reserves the right to make changes in specifications and features shown without notice or obligation.

Meter Pedestals

200 Amps | 4 Terminals | Ringless | 600V

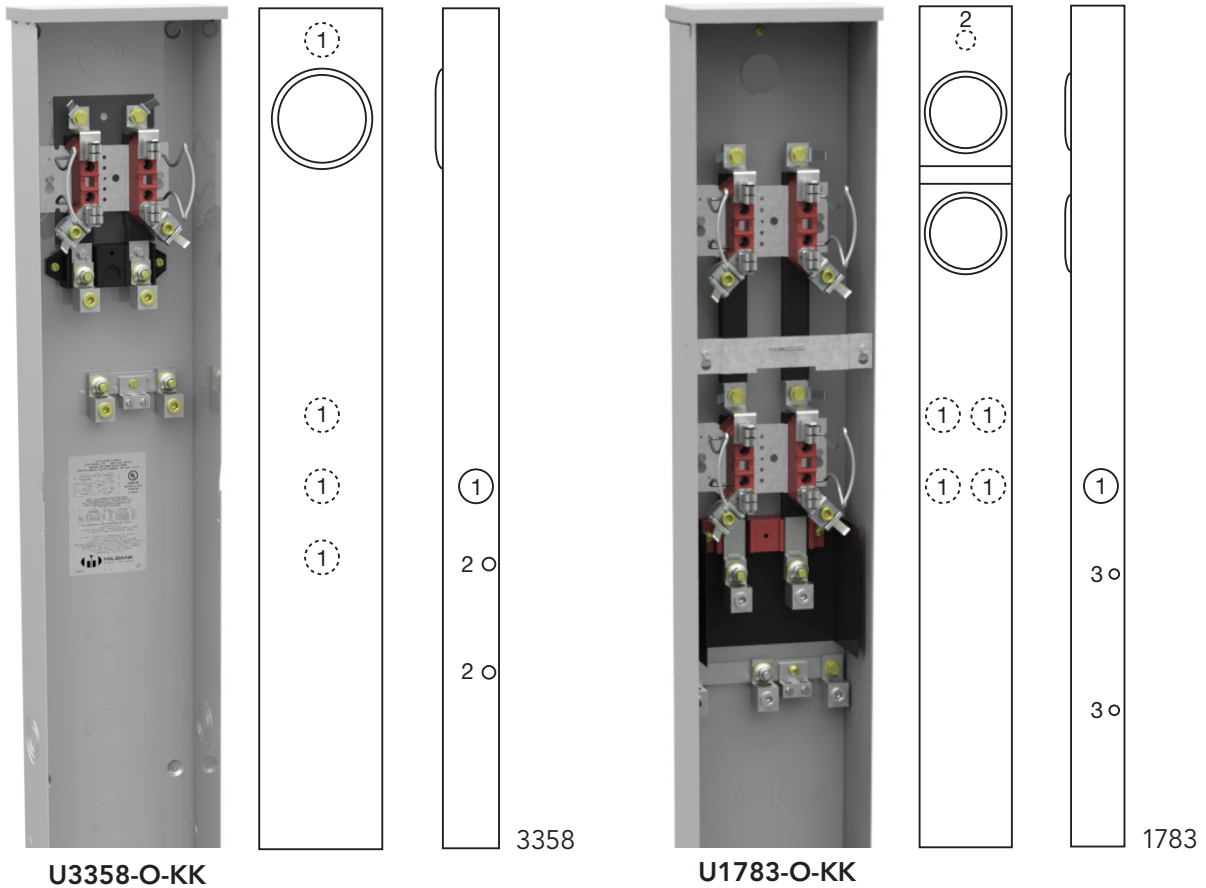

U3358-O-KK

U1783-O-KK

200 Amps | 4 Terminals | Meter Pedestals | Horn Bypass | Ringless

Catalog Number	Positions	Terminals	Service	Hub	Connectors CU/AL		Bypass	Dimensions			Knockouts		
					Line	Load		D"	W"	H"	1	2	3
U3358-O-KK*	1	4	UG	Blank	#6-350	#6-350	Horn	4 ⁷ / ₈	9	62	2	3 ⁴ / ₄	—
U1783-O-KK	2	4	UG	Blank	#6-350	#6-350	Horn	4 ¹ / ₂	8 ¹ / ₂	74	2 ¹ / ₂	1 ¹ / ₃	1 ¹ / ₂

Notes

- **Extension Unit:** For 15-inch burial applications for the **U3358**, order extension unit **K5800**; for 30-inch burial applications, order two of **K5800**. For the **U1783**, order **S8988**.
- **Fifth Terminal:** For field-installable fifth terminal, order **K5T** to install in the 9 o'clock position.
- **Horn Bypass:** The horn bypass is factory-installed and permits changing and testing of the meter without interrupting customer service when used with utility-supplied jumpers.
- **Short Circuit Current Rating:** The **U3358** has a 30k SCCR rating.

Please consult serving utility for their requirements prior to ordering or installing, as specifications and approvals vary by utility, and may require local electrical inspector approval. All installations must be installed by a licensed electrician and must comply with all national and local codes, laws and regulations. Milbank reserves the right to make changes in specifications and features shown without notice or obligation.



Lever Bypass Meter Pedestals

200 Amps | 4 & 5 Terminals | Ringless | 600V

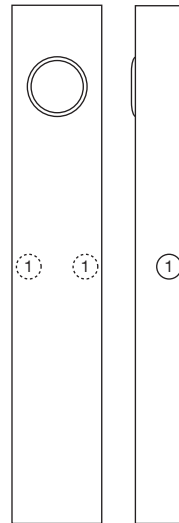

4724

U4724-O-5T9

200 Amps | 4-5 Terminals | Meter Pedestals | Lever Bypass | Ringless

Catalog Number	Terminals	Voltage	Service	Hub	Connectors CU/AL		Bypass	Dimensions			Knockouts
					Line	Load		D"	W"	H"	
U4724-O	4	600	UG	Blank	3/0-4/0	#6-350	Lever	6	11	64	2½
U4724-O-5T9	5	600	UG	Blank	3/0-4/0	#6-350	Lever	6	11	64	2½

Notes

- **Bypass:** Lever provides clamping action on meter spades and also operates bypass device.
- **Fifth Terminal Kit:** For field-installable fifth terminal, order catalog number **K3865** (neutral wire provided). Units with **-5T9** suffix supplied with fifth terminal factory-installed at 9 o'clock.
- **MGE Applications:** The **U4724-O-5T9** is for single-phase, three-wire use only on Madison Gas and Electric lines.



Please consult serving utility for their requirements prior to ordering or installing, as specifications and approvals vary by utility, and may require local electrical inspector approval. All installations must be installed by a licensed electrician and must comply with all national and local codes, laws and regulations. Milbank reserves the right to make changes in specifications and features shown without notice or obligation.

Lever Bypass Meter Pedestals

33

200 Amps | 5-7 Terminals | Ringless | 600V

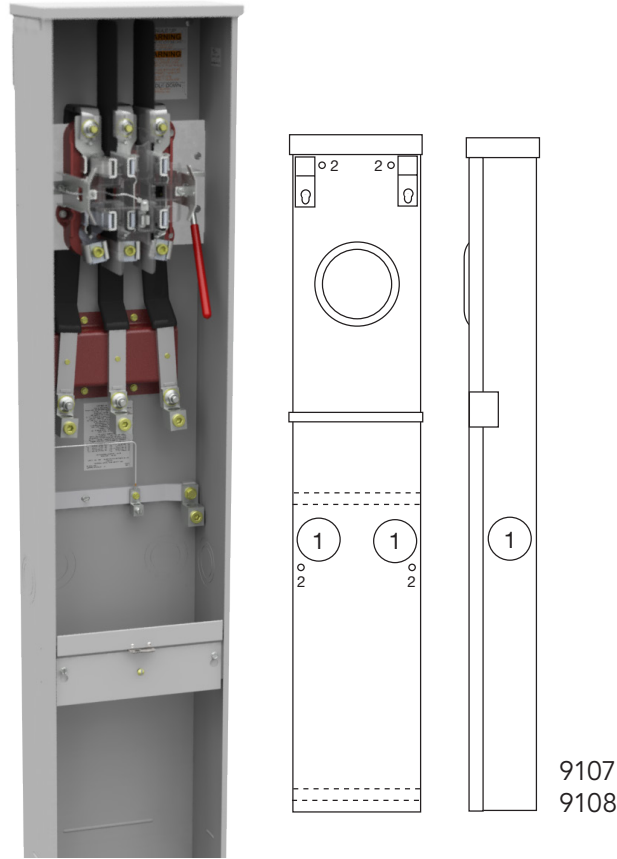

U9107-O-WI

200 Amps | 5-7 Terminals | Meter Pedestals | Lever Bypass | Ringless

Catalog Number	Terminals	Phase	Service	Hub	Connectors	Bypass	Dimensions			Knockouts	
					CU/AL		D"	W"	H"	1	2
U9108-O-WI	5	1Ø3W or 3Ø3W	UG	Blank	#6-350	Lever	6	11	58	2½	5/16
U9107-O-WI	7	3Ø4W	UG	Blank	#6-350	Lever	6	11	58	2½	5/16
U9107-O-CECHA	7	3Ø4W	UG	Blank	#6-350	Lever	6	11	58	2½	5/16

Notes

- **Bypass:** The lever operates bypass device and supplies clamping action to meter spades.
- **Neutral Disconnect:** The **U9108** has a manual neutral disconnect bolt.
- **Direct Burial:** For free standing use, order burial kit **S3488** separately.
- **Single Phase:** To use **U9108** in single-phase applications, field install kit **K6027** (ordered separately).
- **MGE Applications:** The **U9108** is for three-phase use only on Madison Gas and Electric lines.

Please consult serving utility for their requirements prior to ordering or installing, as specifications and approvals vary by utility, and may require local electrical inspector approval. All installations must be installed by a licensed electrician and must comply with all national and local codes, laws and regulations. Milbank reserves the right to make changes in specifications and features shown without notice or obligation.



320 Amps | 4-5 Terminals | Ringless | 600V



U1748-O-WI

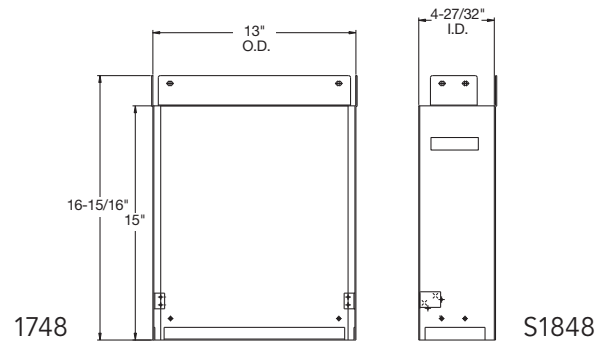
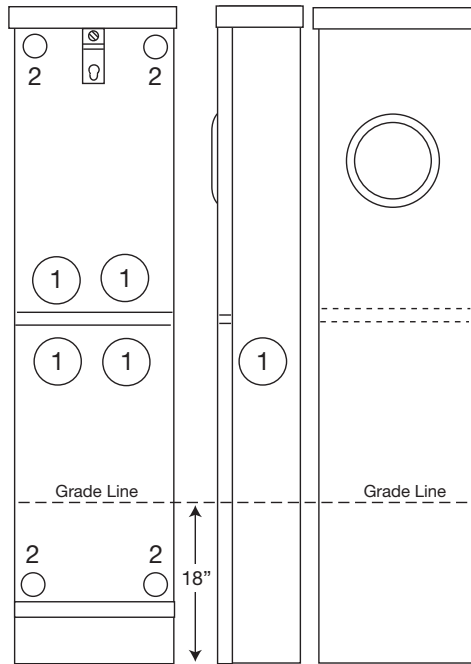

320 Amps | 4-5 Terminals | Meter Pedestals | Lever Bypass | Ringless

Catalog Number	Terminals	Service	Hub	Connectors CU/AL		Bypass	Dimensions			Knockouts	
				Line	Load		D"	W"	H"	1	2
U1748-O-WI	4	UG	Blank	#6-350	(2) #6-350	Lever	4 ⁷ / ₈	13	64	2 ¹ / ₂	5 ⁵ / ₁₆
U1748-O-5T9-WI	5	UG	Blank	#6-350	(2) #6-350	Lever	4 ⁷ / ₈	13	64	2 ¹ / ₂	5 ⁵ / ₁₆

Notes

- **Connectors:** On the **U1748** and **U1748**, the connectors **K1539** (single 350 kcmil) are factory-installed on the line side. Load side is furnished with **K1350** (twin 350 kcmil).
- **Extension Kit:** For extension kit, order as extra, catalog number **S1848**.
- **Bypass:** The lever operates bypass device and supplies clamping action to meter spades.
- **Hanging Hook:** Units supplied with hanger hooks for easy mounting.
- **Short Circuit Current Rating:** These units are rated 22K AIC. Watthour meter not included in short circuit current rating.



Please consult serving utility for their requirements prior to ordering or installing, as specifications and approvals vary by utility, and may require local electrical inspector approval. All installations must be installed by a licensed electrician and must comply with all national and local codes, laws and regulations. Milbank reserves the right to make changes in specifications and features shown without notice or obligation.

Meter Main Pedestals

100–200 Amps | 4 Terminals | Ringless | 120/240V

NEC 2023 Compliant

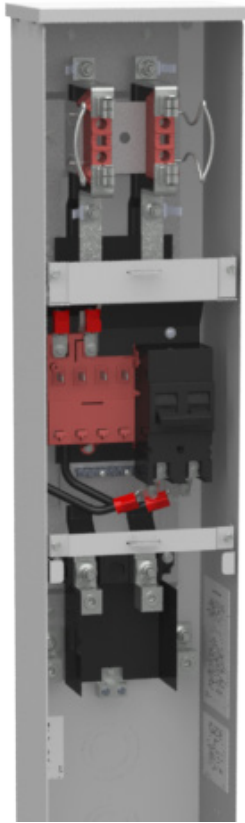

U6689-O-100-KK

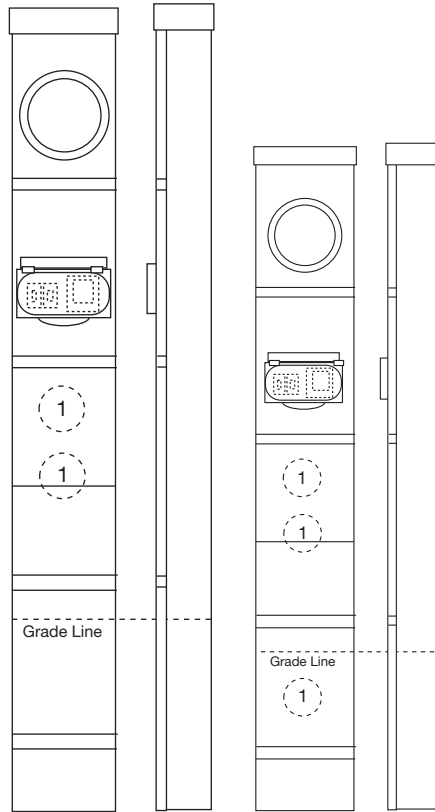

6689

6689-LP

100 - 200 Amps | 4 Terminals | Meter Main Pedestals | Horn Bypass | 22K AIC | Ringless

Catalog Number	Service	Main Breaker	Hub	Connectors CU/AL		Dimensions			Knockouts
				Line	Load	D"	W"	H"	
U6689-O-100-KK	UG	100	Blank	#6-350	CB*	6	9	79	2½
U6689-O-100-KK-LP*	UG	100	Blank	#6-350	CB*	6	9	70	2½
U6689-O-200-KK	UG	200	Blank	#6-350	CB*	6	9	79	2½
U6689-O-200-KK-LP*	UG	200	Blank	#6-350	CB*	6	9	70	2½

Notes

- **Series Wired Main:** Standard from factory.
- **Branch Circuit Breakers:** Branch interior accepts most manufacturers' small frame plug-in type circuit breakers (Milbank, GE, Siemens, Cutler-Hammer).
- **Fifth Terminal:** For field-installed fifth terminal order kit K5T. Mounts in 9 o'clock position only.
- **Extension Kit:** Available for low profile (-LP) units only. Order kit K4694.

*LP: Low profile.

Please consult serving utility for their requirements prior to ordering or installing, as specifications and approvals vary by utility, and may require local electrical inspector approval. All installations must be installed by a licensed electrician and must comply with all national and local codes, laws and regulations. Milbank reserves the right to make changes in specifications and features shown without notice or obligation.



36 Meter Main with Load Center Pedestals

200 Amps | 4 Terminals | Ringless | 120/240V

NEC 2023 Compliant



U5136-O-200S

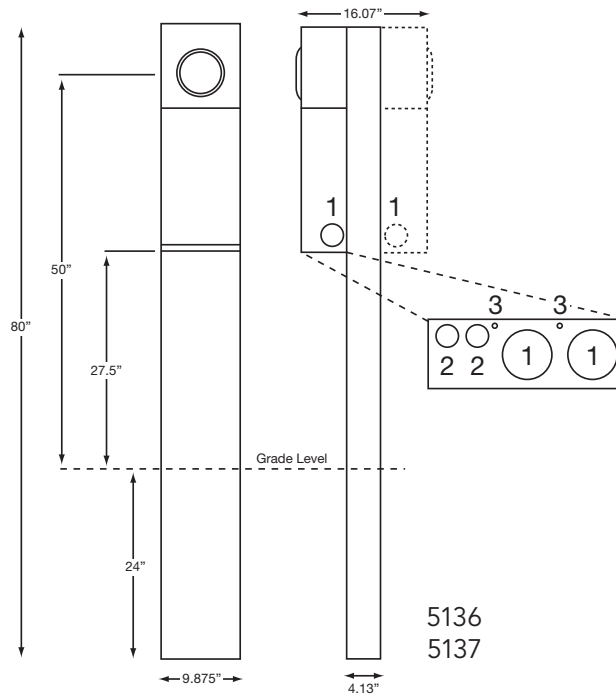

5136
5137

200 Amps | 4 Terminals | Meter Main Pedestals | Horn Bypass | Ringless

Catalog Number	Service	AIC Rating	Connectors CU/AL		Circuits	Dimensions			Knockouts		
			Line	Load		D"	W"	H"	1	2	3
U5136-O-100S	UG	22K	#6-350	CB	4	4 $\frac{1}{8}$	9 $\frac{7}{8}$	80	2	1 $\frac{1}{2}$, 3 $\frac{3}{4}$	1 $\frac{1}{4}$
U5136-O-150S	UG	22K	#6-350	CB	4	4 $\frac{1}{8}$	9 $\frac{7}{8}$	80	2	1 $\frac{1}{2}$, 3 $\frac{3}{4}$	1 $\frac{1}{4}$
U5136-O-200S	UG	22K	#6-350	CB	4	4 $\frac{1}{8}$	9 $\frac{7}{8}$	80	2	1 $\frac{1}{2}$, 3 $\frac{3}{4}$	1 $\frac{1}{4}$
U5137-O-100S	UG	22K	#6-350	CB	8	4 $\frac{1}{8}$	9 $\frac{7}{8}$	80	2	1 $\frac{1}{2}$, 3 $\frac{3}{4}$	1 $\frac{1}{4}$
U5137-O-150S	UG	22K	#6-350	CB	8	4 $\frac{1}{8}$	9 $\frac{7}{8}$	80	2	1 $\frac{1}{2}$, 3 $\frac{3}{4}$	1 $\frac{1}{4}$
U5137-O-200S	UG	22K	#6-350	CB	8	4 $\frac{1}{8}$	9 $\frac{7}{8}$	80	2	1 $\frac{1}{2}$, 3 $\frac{3}{4}$	1 $\frac{1}{4}$

Notes

- **Fifth Terminal:** For field-installable fifth terminal, order **K5T**.
- **Stabilizer Foot:** For field-installable stabilizer foot, order **K5415**.
- **Penta Bolt Locking:** For field-installable pedestal fronts with penta bolt locking, order **K5039**.
- **Receptacles:** Consult factory for installed receptacle assemblies.
- **U5137:** Double power head version.
- **Branch Circuit Breakers (Four Additional one-pole Spaces):** Branch interior accepts most manufacturers' small frame plug-in type circuit breakers (GE, Siemens, Cutler-Hammer, Murray). Load center rated up to 125 Amps.
- Use part number **K6265-HRD** when adding a 120 VAC 20 Amps GFI receptacle in Alliant territory.



Please consult serving utility for their requirements prior to ordering or installing, as specifications and approvals vary by utility, and may require local electrical inspector approval. All installations must be installed by a licensed electrician and must comply with all national and local codes, laws and regulations. Milbank reserves the right to make changes in specifications and features shown without notice or obligation.

Meter Main with Load Center Pedestals 37

200 Amps | 4 Terminals | Ringless | 120/240V

NEC 2023 Compliant

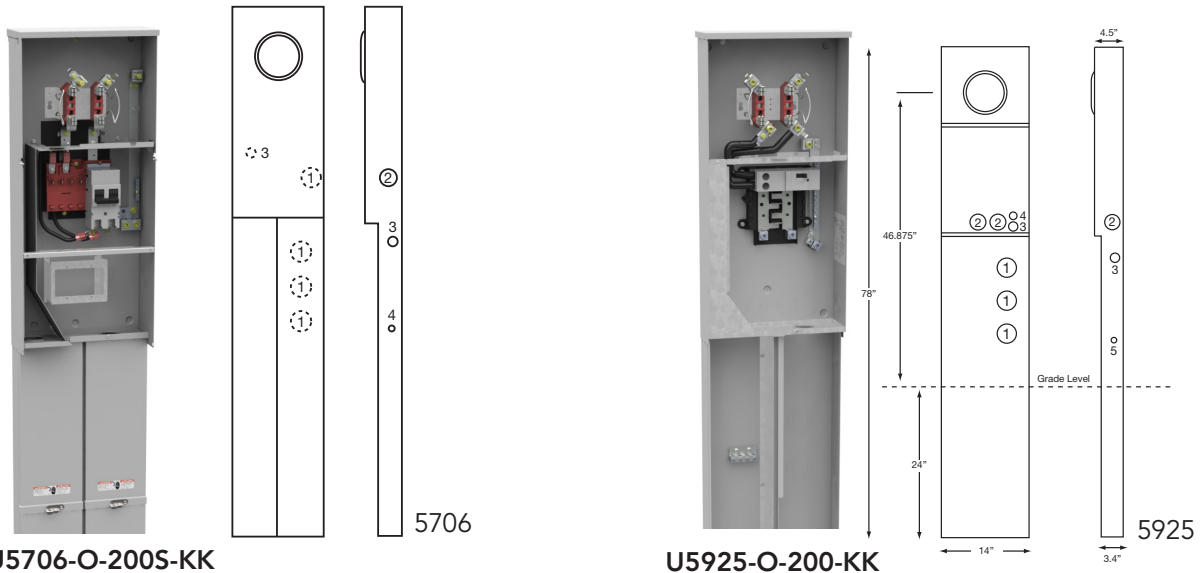

U5706-O-200S-KK

Picture shown with bridge installed

(Catalog Number: K5400-BRIDGE-3POS)

U5925-O-200-KK

100-200 Amps | 4 Terminals | Meter Main Pedestals | Horn Bypass | Ringless

Catalog Number	Service	Connectors CU/AL		Circuits	Dimensions			Knockouts			
		Line	Load		D"	W"	H"	1	2	3	4
U5706-O-100S-KK	UG	#6-350	CB	4	5½	14	80	2½	2	1	¼, ½
U5706-O-200S-KK	UG	#6-350	CB	4	5½	14	80	2½	2	1	¼, ½

100-200 Amps | 4 Terminals | All-In-One Pedestals | Horn Bypass | Ringless

Catalog Number	Service	Connectors CU/AL		Circuits	Dimensions			Knockouts				
		Line	Load		D"	W"	H"	1	2	3	4	5
U5925-O-100-KK	UG	#6-350	CB	10	3⅞	14	78	2½	2	1	½, ¾	¼, ½
U5925-O-150-KK	UG	#6-350	CB	8	3⅞	14	78	2½	2	1	½, ¾	¼, ½
U5925-O-200-KK	UG	#6-350	CB	8	3⅞	14	78	2½	2	1	½, ¾	¼, ½

Notes

- **Fifth Terminal:** For field-installable fifth terminal, order **K5T**.
- **Branch Circuit Breakers (Four Additional one-pole Spaces):** Branch interior accepts most manufacturers' small frame plug-in type circuit breakers (GE, Siemens, Cutler-Hammer, Murray). Load center rated up to 125 Amps.
- Use part number **K6265-HRD** when adding a 120V 20 Amps GFI receptacle in Alliant territory.

Generator Interlock (compatible with U5925)

	K5815 Large QN with small frame Q	K5820 Large frame QN with large frame QN	K5830 Small frame Q to small frame Q
--	---	--	--

Please consult serving utility for their requirements prior to ordering or installing, as specifications and approvals vary by utility, and may require local electrical inspector approval. All installations must be installed by a licensed electrician and must comply with all national and local codes, laws and regulations. Milbank reserves the right to make changes in specifications and features shown without notice or obligation.



38 Meter Main with Load Center Pedestals

200 Amps | 5 Terminals | Lever Bypass | 120/240V



U4322-O-5T9

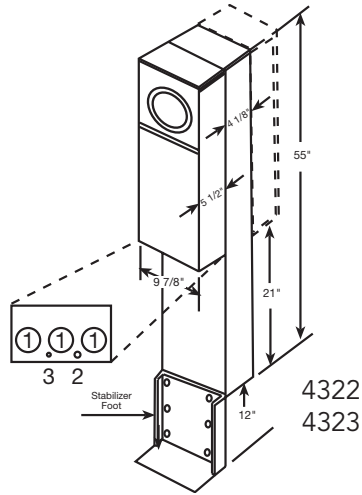

U4323-O-5T9

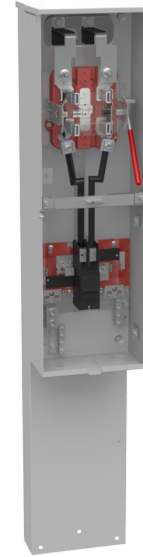

U4322-O-200MB-5T9*

200 Amps | 5 Terminals | Meter Main Pedestals | Heavy Duty | Lever Bypass | Ringless

Catalog Number	Meter Positions	Connectors CU/AL		Circuit Provisions	Bypass	Dimensions			Knockouts		
		Line	Load			D"	W"	H"	1	2	3
U4322-O-5T9	Single	(2) #6-350	CB	6	Lever	9 ⁵ / ₈	9 ⁷ / ₈	55	2	1/2	1/4
U4323-O-5T9	Double	(2) #6-350	CB	6	Lever	15 ¹ / ₈	9 ⁷ / ₈	55	2	1/2	1/4
U4322-O-200MB-5T9*	Single	#6 - 350	CB	6	Lever	9 ⁵ / ₈	9 ⁷ / ₈	55	2	1/2	1/4
U4323-O-200MB-5T9*	Double	(2) #6-350	CB	6	Lever	15 ¹ / ₈	9 ⁷ / ₈	55	2	1/2	1/4

Notes

- **Bypass:** Lever provides clamping action on meter spades and also operates bypass device.
- **Application:** The U4322 and U4323 pedestals are suitable for use as service equipment or mobile home service equipment. K5081/K3188 for direct burial application is included with unit. K5151 for pad-mount application must be ordered as extra.
- **Branch Circuit Breakers:** These units are wired as parallel mains and have provisions for six circuits: six-pole or three two-pole breakers. Breakers not included. Order separately (see chart below).
- **Short Circuit Current Rating:** These units are rated 10K AIC. However, this rating is limited to the lowest interrupting capacity of any circuit breaker installed. Watthour meter not included in short circuit current rating.

* NEC 2023 Compliant

Breaker Chart

Manufacturer	150–200 Amps	125 Amps or Less
Cutler-Hammer	BJ, WBJ	Quicklag P BR, HQP
Siemens (ITE)	QNR	QP
Murray	MD	MP
GE	—	Q Line
Square D	—	Homeline



Please consult serving utility for their requirements prior to ordering or installing, as specifications and approvals vary by utility, and may require local electrical inspector approval. All installations must be installed by a licensed electrician and must comply with all national and local codes, laws and regulations. Milbank reserves the right to make changes in specifications and features shown without notice or obligation.

Meter Main with Load Center Pedestals

39

100-200 Amps | 5 Terminals | Ringless | 120/240V

NEC 2023 Compliant



U5701-O-200S

Picture shown with bridge installed.
(Catalog number: K5400-BRIDGE-3POS)

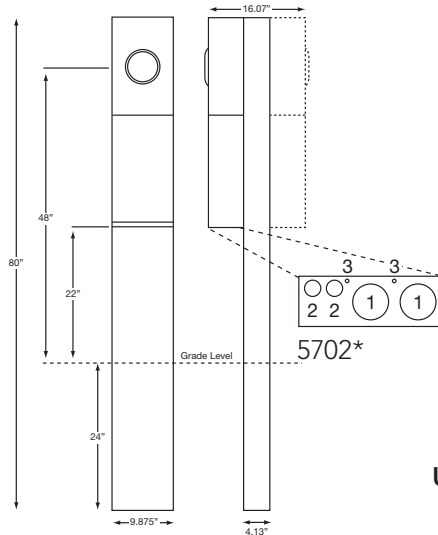

U6221-O-100-10GR

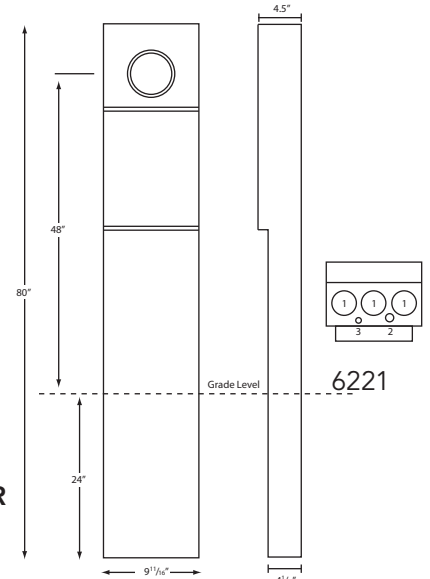

100-200 Amps | 5 Terminals | Meter Main Pedestals | Heavy Duty Lever Bypass | Ringless | 1Ø3W

Catalog Number	Meter Positions	Circuit Provisions	Mounting Type	Number of Power Units	Twin Line Connectors CU/AL	Dimensions			Knockouts		
						D"	W"	H"	1	2	3
U5701-O-100S	Single	4	D.B. Post	1	#6-350	4 1/8	9 7/8	80	2	3/4	1/4
U5701-O-150S	Single	4	D.B. Post	1	#6-350	4 1/8	9 7/8	80	2	3/4	1/4
U5701-O-200S	Single	4	D.B. Post	1	#6-350	4 1/8	9 7/8	80	2	3/4	1/4

100-200 Amps | 4 Terminal | All-In-One Pedestals | Lever Bypass | Ringless

Catalog Number	Service	Bypass	Circuits	Connectors CU/AL		Dimensions			Knockouts		
				Line	Load	D"	W"	H"	1	2	3
U6221-O-100-10GR*	UG	Lever	10	#6-350	CB	4 1/8	9 11/16	80	2	1/2	1/4
U6221-O-200-10GR*	UG	Lever	8	#6-350	CB	4 1/8	9 11/16	90	2	1/2	1/4

Notes

- **Bypass:** Lever provides clamping action on meter spades and also operates bypass device.
 - **Fifth Terminal:** For field-installable fifth terminal, kit order **K5T**.
 - **Branch Circuit Breakers:** For **U5701**, quadplex style breakers may be used in accordance with the NEC. If main breaker is used, there are provisions for two two-pole breakers or four one-pole breakers in series. Branch interior of **U6221** accepts most manufacturers' small frame plug-in type circuit breakers (GE, Siemens, Cutler-Hammer, Murray).
 - **Kits:** For **5701** and **5702** order stabilizer kit **K5415**. For **5703**, order pad-mount kit **K5035**.
 - **Surface-mount:** **U6221** with 10GR includes the 520GR surface-mount.
 - **Receptacles:** If receptacles are required, contact factory for additional kit information. Two outlet devices maximum can be installed.
- *When used in an Alliant territory, the **U6221** must have a shielded GFI receptacle. Use kit number **K6265-HRD**.

Please consult serving utility for their requirements prior to ordering or installing, as specifications and approvals vary by utility, and may require local electrical inspector approval. All installations must be installed by a licensed electrician and must comply with all national and local codes, laws and regulations. Milbank reserves the right to make changes in specifications and features shown without notice or obligation.



320 Amps | 4 Terminals | Lever Bypass | 120/240V



U3849-O-2-200

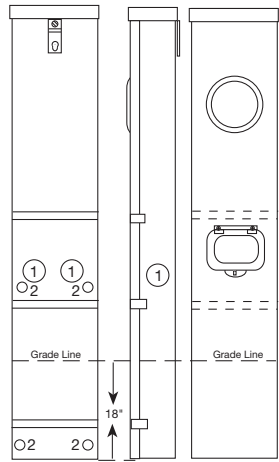

3849

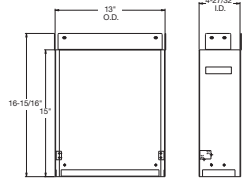

S1848



U6317-O-2-150

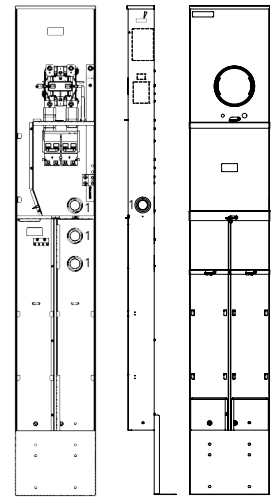

6317

320 Amps | 4 Terminals | Meter Main Pedestals | Lever Bypass | Ringless

Catalog Number	Terminals	Service	Hub	Connectors CU/AL		Dimensions			Knockouts	
				Line	Load	D"	W"	H"	1	2
U3849-O-200-100	4	UG	Blank	3/8" x 16 Studs	1/0-300	47/8	13	64	21/2	5/16
U3849-O-2/150	4	UG	Blank	3/8" x 16 Studs	1/0-300	47/8	13	64	21/2	5/16
U3849-O-2/200	4	UG	Blank	3/8" x 16 Studs	1/0-300	47/8	13	64	21/2	5/16

Alliant Approved* | 300 Amps | 4 Terminals | Meter Main with Breakers | Lever Bypass | Ringless

Catalog Number	Terminals	Service	Hub	Connectors CU/AL		Dimensions			Knockouts	
				Line	Load	D"	W"	H"	1	2
U6317-O-2/150-K3L	4	UG	Blank	3/8" x 16 Studs	Twin #6-350	47/8	13	64	2 1/2	5/16
U6317-O-100-200-K3L	4	UG	Blank	3/8" x 16 Studs	Twin #6-350	47/8	13	64	2 1/2	5/16

Notes

- **Breakers:** Supplied from factory with two two-pole, Milbank **UQFB** or **UQFBH** (22K AIC) bolt-on circuit breakers.
 - **Connectors:** The line wire section is supplied with 3/8"-16 studs with hex nuts and captive Belleville washers. For line side connectors, order as extra catalog numbers **K1539** (single 350 kcmil), or **K1540** (single 600 kcmil), or for twin order **K1350** (twin 350 kcmil). Order one kit per unit.
 - **Extension Kit:** For extension kit, order as extra catalog number **S1848**.
 - **Bypass:** The lever operates bypass device and supplies clamping action to meter spades.
 - **Short Circuit Current Rating:** These units are rated 22K AIC. However, this rating is limited to the lowest interrupting capacity of any circuit breaker installed. Watthour meter not included in short circuit current rating.
- *Alliant Approved: Limited to 300 Amps for **U6317** only



Please consult serving utility for their requirements prior to ordering or installing, as specifications and approvals vary by utility, and may require local electrical inspector approval. All installations must be installed by a licensed electrician and must comply with all national and local codes, laws and regulations. Milbank reserves the right to make changes in specifications and features shown without notice or obligation.

Meter Main Pedestals

41

320 Amps | 4 Terminals | Lever Bypass | 120/240V

NEC 2023 Approved

**NEED PHOTOS FOR
THESE PRODUCTS**

320 Amps | 4 Terminals | Meter Main Pedestals | Lever Bypass | Ringless

Catalog Number	Terminals	Service	Hub	Connectors CU/AL		Dimensions			Knockouts	
				Line	Load	D"	W"	H"	1	2
U6318-O-2/150-K3L	4	UG	Blank	3/8" x 16 Studs	1/0-300	47/8	13	64	21/2	5/16

Alliant Approved* | 300 Amps | 4 Terminals | Meter Main with Breakers | Lever Bypass | Ringless

Catalog Number	Terminals	Service	Hub	Connectors CU/AL		Dimensions			Knockouts	
				Line	Load	D"	W"	H"	1	2
U6318-O-100-200-K3L	4	UG	Blank	3/8" x 16 Studs	Twin #6-350	47/8	13	64	21/2	5/16

Notes

- **Breakers:** Supplied from factory with two two-pole, Milbank **UQFB** or **UQFBH** (22K AIC) bolt-on circuit breakers.
- **Connectors:** The line wire section is supplied with 3/8"-16 studs with hex nuts and captive Belleville washers. For line side connectors, order as extra catalog numbers **K1539** (single 350 kcmil), or **K1540** (single 600 kcmil), or for twin order **K1350** (twin 350 kcmil). Order one kit per unit.
- **Extension Kit:** For extension kit, order as extra catalog number **S1848**.
- **Bypass:** The lever operates bypass device and supplies clamping action to meter spades.
- **Short Circuit Current Rating:** These units are rated 22K AIC. However, this rating is limited to the lowest interrupting capacity of any circuit breaker installed. Watthour meter not included in short circuit current rating.

*Alliant Approved: Limited to 300 Amps for **U6317** only

Please consult serving utility for their requirements prior to ordering or installing, as specifications and approvals vary by utility, and may require local electrical inspector approval. All installations must be installed by a licensed electrician and must comply with all national and local codes, laws and regulations. Milbank reserves the right to make changes in specifications and features shown without notice or obligation.



Joint Use Termination Cabinet

Accommodates Telephone and Cable Conductors



U4329-O

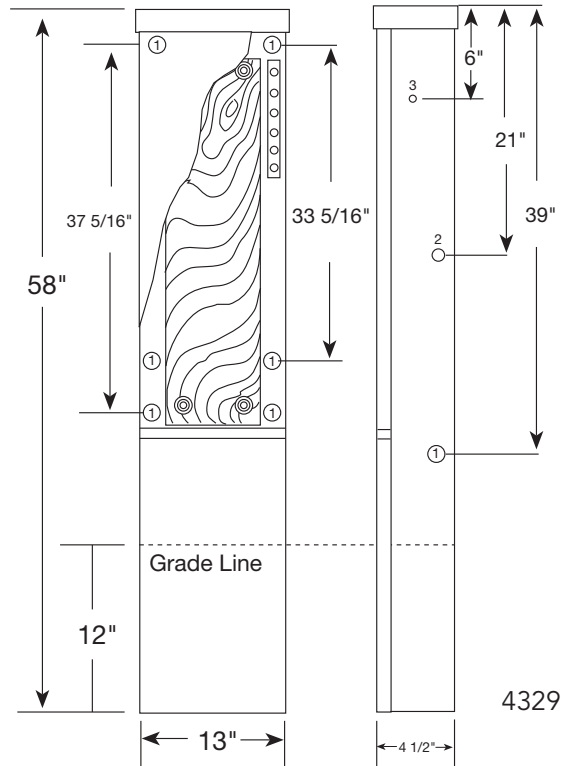

4329

Joint Use Termination Cabinet

Catalog Number	Hub	Connectors CU/AL		Bypass	Dimensions			Knockouts		
		Line	Load		D"	W"	H"	1	2	3
U4329-O	Blank	None	None	None	4 ⁷ / ₈	13	58	1	1/2	7/16

Notes

- **Communication Compartment:** Easily attaches to Milbank meter pedestals for use in new construction.
- **Telephone and Cable Conductors:** This unit will accommodate both telephone and cable conductors, eliminating the use of multiple, unsightly network interface devices on the outer structure of the home, while providing tamper resistance to the communication modules.
- **Single Location Point of Service:** The U4329 combined with the Milbank meter pedestal provides a single location point of service, making access for utility service personnel convenient and efficient.



Please consult serving utility for their requirements prior to ordering or installing, as specifications and approvals vary by utility, and may require local electrical inspector approval. All installations must be installed by a licensed electrician and must comply with all national and local codes, laws and regulations. Milbank reserves the right to make changes in specifications and features shown without notice or obligation.

Polyphase Enclosures

For "A" Base Meters

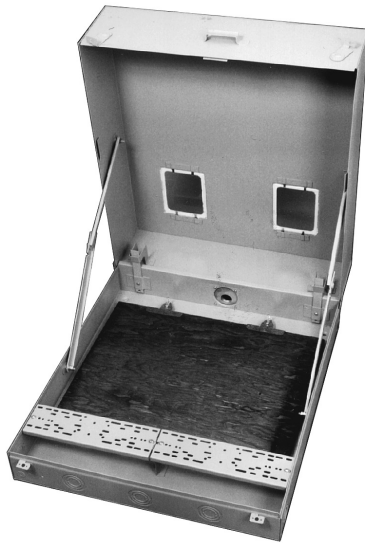

S9997-B-XL

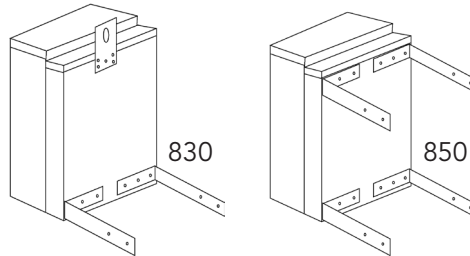

Pole-Mounting Brackets

Order #830 for one pair (2 pcs.) with keyhole bracket and mounting hardware.
Order #850 for two pair (4 pcs.) with mounting hardware.



S9995-B-XL

Polyphase Enclosures

Catalog Number	Hub	Positions	Dimensions		
			D"	W"	H"
S9995-B-XL	C.P.	1	11	15	26
S9996-B-XL	C.P.	1	11	15	30 ^{11/16}
S9997-B-XL	C.P.	2	11	27	30 ^{11/16}

Notes

- **Bridge and Mounting Board:** Units are supplied with board and bridge.
- **Windows and Covers:** Units supplied with one 4½" x 6 glass window per meter position. If glass demand reset window is desired, add suffix **-CW** to the catalog number. If metal demand reset cover is desired, add suffix **-C** to the catalog number. If window shield is desired, add suffix **-WS** to the catalog number.
- **Hubs:** Units supplied with closing plate. To order hub as extra, refer to the accessories page.

Field-installed Accessories

Glass Window Demand Reset Cover	All Metal Demand Reset Cover	Window Shield
SDRCW	SDRC	WS

Please consult serving utility for their requirements prior to ordering or installing, as specifications and approvals vary by utility, and may require local electrical inspector approval. All installations must be installed by a licensed electrician and must comply with all national and local codes, laws and regulations. Milbank reserves the right to make changes in specifications and features shown without notice or obligation.



Type K4 Meter Sockets

4 Terminals | 480 Amps | Ringless | 300V



U4664-X

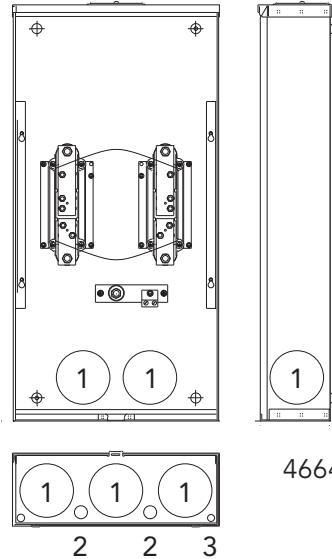

4664

480 Amps | 4 Terminals | OH/UG Service | Ringless

Catalog Number	Hub	L & G Number	Lug Kit	Connectors CU/AL		Dimensions			Knockouts		
				Line	Load	D"	W"	H"	1	2	3
U4664-X-8502	C.P.	9810-8502	Installed	(2) #6-350	(2) #6-350	6	17 ³ / ₄	36	4	1/2, 3/4	1/4
U4664-X-8507	C.P.	9810-8507	None	1/2"-20 Studs	1/2"-20 Studs	6	17 ³ / ₄	36	4	1/2, 3/4	1/4
U4664-X-9507	(2) C.P.	9810-9507	None	1/2"-20 Studs	1/2"-20 Studs	6	17 ³ / ₄	36	4	1/2, 3/4	1/4

Notes

- **Application:** For use with 1Ø3W self-contained Type MS-K watt-hour meters.
- **Capacity:** 480 Amps continuous, 600 Amps maximum.
- **Connectors:** 1/2"-20 plated steel studs with nuts and captive Belleville washers to accommodate various bolt-on type lugs for conductors from #6 to 800 kcmil CU or AL. Use 3/4" insulated wrench to fasten connectors to block. **U4664-X-8502** includes phase and neutral connectors. For lugs, refer to pages 44-46.
- **Enclosure:** Constructed of 14-gauge galvanized steel suitable for indoor or outdoor installations.
- **Bypass:** Rated 50%, separate manual type, order Milbank kit **K4687** (kit includes two bypasses).
- **Meter Mounting:** Two position stud type. One set of studs provides out-of-service storage. The in-service studs are positioned so the meter cannot be installed upside down. Full travel meter opening slide plate eliminates the need for repositioning the slide plate for the "IN" or "OUT OF SERVICE" position.
- **Blocks:** Glass fiber reinforced polyester plastic. High arc withstand strength and track resistant. Provisions for lighting arresters.



Please consult serving utility for their requirements prior to ordering or installing, as specifications and approvals vary by utility, and may require local electrical inspector approval. All installations must be installed by a licensed electrician and must comply with all national and local codes, laws and regulations. Milbank reserves the right to make changes in specifications and features shown without notice or obligation.

Type K7 Meter Sockets

7 Terminals | 480 Amps | Ringless | 600V

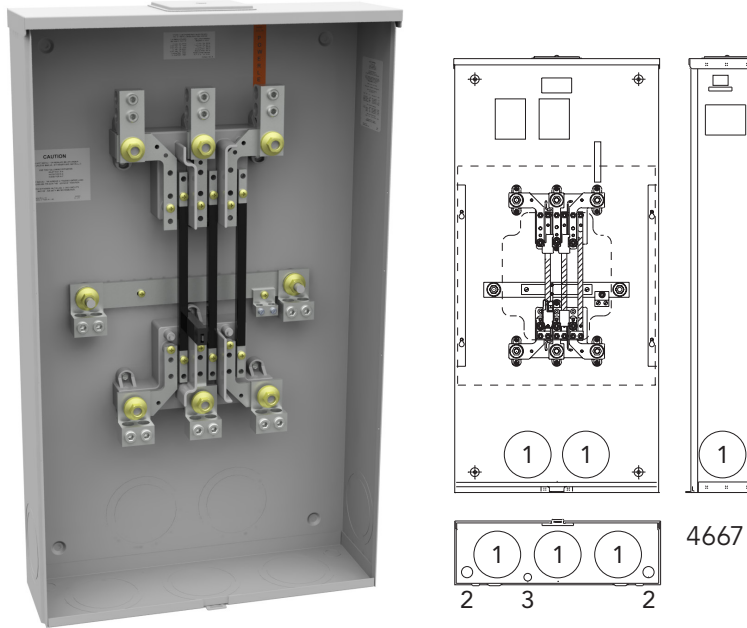

U4667-X-8013

480 Amps | 7 Terminals | Type K7 Meter Sockets | Ringless

Catalog Number	Service	Hub	L & G Number	Lug Kit	Connectors CU/AL		Dimensions			Knockouts		
					Line	Load	D"	W"	H"	1	2	3
U4667-X-8512	OH/UG	C.P.	9817-8512	Installed	(2) 4-500	(2) 4-500	6	20¼	43	4	½, ¾	¼
U4667-XT-9504	OH/UG	(2) C.P.	9817-9504	None	1/2"-20 Studs	1/2"-20 Studs	6	20¼	43	4	½, ¾	¼
U4667-XT-9506	OH/UG	(2) C.P.	9817-9506	Installed	(2) 4-500	(2) 4-500	6	20¼	43	4	½, ¾	¼
U4667-X-8013	OH/UG	C.P.	9817-8013	Installed	(2) 4-500	(2) 4-500	6	20¼	43	4	½, ¾	¼

Notes

- **Application:** For use with self-contained Type MT-K wattour meters on 3Ø4W Wye or 4-wire Delta services.
- **Capacity:** 480 Amps continuous, 600 Amps maximum.
- **Connectors:** ½"-20 plated steel studs with nuts and captive Belleville washers to accommodate various bolt-on type lugs for conductors from #6 to 800 kcmil CU or AL. Use ¾" insulated wrench to fasten connectors to block. For lugs, refer to page 45-46.
- **Enclosure:** Constructed of 14-gauge galvanized steel suitable for indoor or outdoor installations.
- **Bypass:** Rated 50%, separate manual type, order Milbank kit **K4688** (kit includes three bypasses).
- **Meter Mounting:** The meter is mounted on six studs using 5/16"-24 studs with nuts with captive Belleville washers. The upper studs are positioned so that the meter cannot be installed upside down. Use ½" insulated wrench. Another set of studs provides onsite "OUT OF SERVICE" storage. Full travel meter opening slide plate eliminates the need for repositioning the slide plate for the "IN" or "OUT OF SERVICE" position.

Please consult serving utility for their requirements prior to ordering or installing, as specifications and approvals vary by utility, and may require local electrical inspector approval. All installations must be installed by a licensed electrician and must comply with all national and local codes, laws and regulations. Milbank reserves the right to make changes in specifications and features shown without notice or obligation.



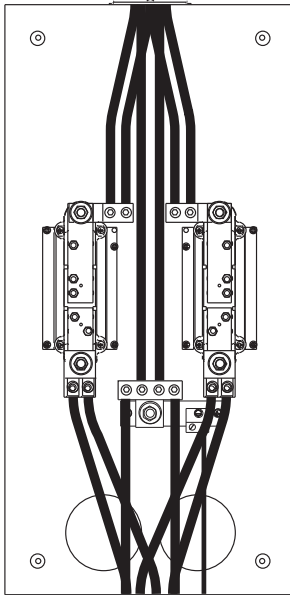

K4 Lug Kit
(overhead)

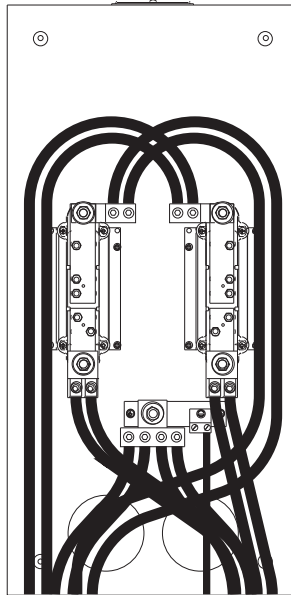

K4 Lug Kit
(underground)

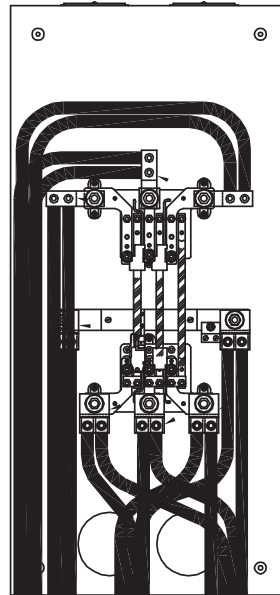

K7 Lug Kit
(underground)

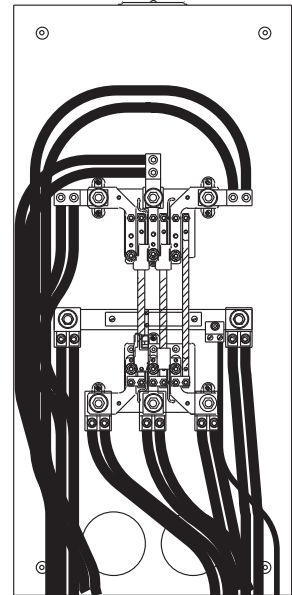

K7 Lug Kit
(underground)

Milbank Connector Number	Line/Load Feed (OH/UG)	Description
Z703917-AC Z705456-AC Z705420-AC	Parallel Line/Load OH/UG	(2) Twin #6-350 kcmil connector (phase) (2) Twin #6-350 kcmil connector (phase) (1) Quad #6-350 connector (neutral)
Z704693-AC Z704694-AC	Parallel Line/Load UG	(3) Twin #2-500 kcmil connector (phase) (5) Twin #4-500 kcmil connector (phase)
Z703919-AC Z703918-AC	Parallel Line/Load UG	(3) Twin #6-350 kcmil connector (phase) (5) Twin #4-350 kcmil connector (phase)

Milbank Bypass	L&G Bypass	Description
K4687	56495	Manual bypass for K-4 Series (U4664). Kit includes 2.
K4688	58888	Manual bypass for K-7 Series (U4667). Kit includes 3.

Notes

- **Bypass:** Rated 50%, separate manual type.



Please consult serving utility for their requirements prior to ordering or installing, as specifications and approvals vary by utility, and may require local electrical inspector approval. All installations must be installed by a licensed electrician and must comply with all national and local codes, laws and regulations. Milbank reserves the right to make changes in specifications and features shown without notice or obligation.

Lugs for K-Series

L&G Cross-Reference

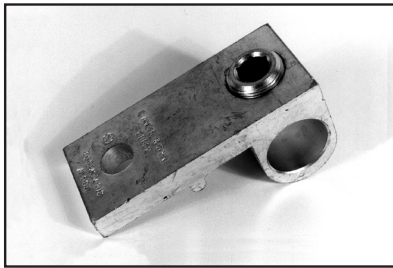

Z703916-AC | 58852

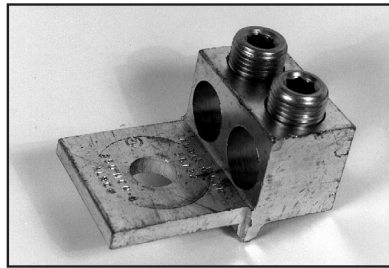

Z703918-AC | 56732
Z704694-AC | 56732-M

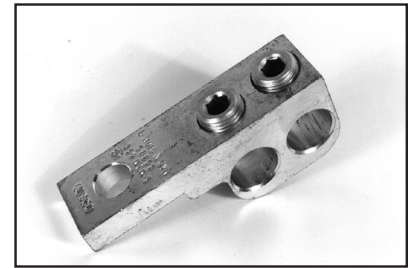

Z703919-AC | 58853
Z704693-AC | 56427-M

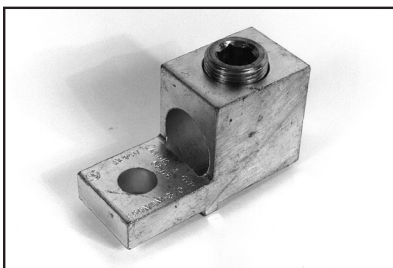

Z703921-AC | 56476

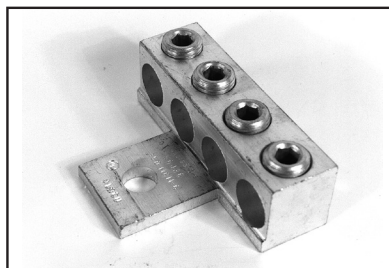

Z705420-AC | 56426

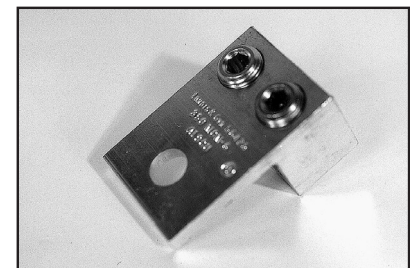

Z705456-AC | 56425

Bolt-on type lugs for Milbank stud type meter mounting devices are made of 6061-T6 aluminum to provide high strength and high conductivity. All lugs are tin plated to ensure low contact resistance and to reduce corrosion. Allen or hex head pressure screws are furnished to provide excellent conductor spread for maximum binding action with the lug.

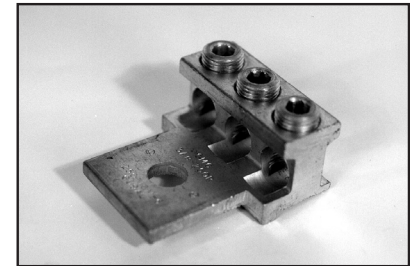
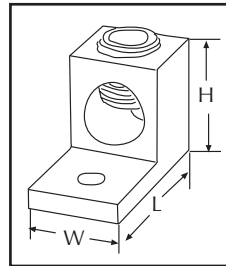

Z708145-AC | 68752-1

Milbank Connector Number	L&G Connector Number	# of Conductors and Size	Stud Opening	Pressure Screw Head	Dimensions		
					L"	W"	H"
Z703916-AC	58852	3/0-800 kcmil	9/16"	1/2" Allen	3 ¹⁵ / ₁₆	1 ³ / ₄	1 ¹³ / ₁₆
Z703917-AC	56427	Two #6-350 kcmil	9/16"	5/16" Allen	4 ⁵ / ₁₆	1 ¹ / ₈	2 ¹ / ₁₆
Z703918-AC	56732	Two #4-350 kcmil	9/16"	5/16" Allen	2 ⁷ / ₈	1 ⁵⁹ / ₆₄	1 ¹ / ₄
Z703919-AC	58853	Two #6-350 kcmil	9/16"	5/16" Allen	3 ¹⁵ / ₁₆	1 ¹ / ₈	1 ¹ / ₂
Z703921-AC	56476	3/0-800 kcmil	9/16"	1/2" Allen	3 ¹ / ₄	1 ⁵ / ₁₆	1 ¹³ / ₁₆
Z704693-AC	56427-M	Two #2-500 kcmil	9/16"	3/8" Allen	4 ¹ / ₄	1 ¹ / ₈	1 ¹³ / ₁₆
Z704694-AC	56732-M	Two #4-500 kcmil	9/16"	3/8" Allen	2 ¹³ / ₁₆	2 ⁵ / ₃₂	1 ¹³ / ₁₆
Z705420-AC	56426	Four #6-350 kcmil	1 ⁷ / ₃₂ "	5/16" Allen	2 ⁷ / ₈	3 ¹⁵ / ₁₆	1 ⁹ / ₁₆
Z705456-AC	56425	Two #6-350 kcmil	9/16"	5/16" Allen	2 ⁷ / ₈	1 ⁵⁷ / ₆₄	1 ¹ / ₄
Z708145-AC	68752-1	Three #6-250 kcmil	9/16"	5/16" Allen	2 ⁷ / ₈	2 ¹ / ₂	1 ⁵ / ₁₆

Please consult serving utility for their requirements prior to ordering or installing, as specifications and approvals vary by utility, and may require local electrical inspector approval. All installations must be installed by a licensed electrician and must comply with all national and local codes, laws and regulations. Milbank reserves the right to make changes in specifications and features shown without notice or obligation.



Attractive | Easy-to-Install | Secure | Cost-Effective

Milbank enclosed controls are an alternative to unsightly and inefficient strut and backboard structures. Enclosed controls are an attractive, secure, easy-to-install and cost-effective solution for underground remote site power distribution. Cabinets are weather-resistant enclosures that can be crafted to suit any environment with various mounting options. Each individual unit features a utility pull section with an optional meter socket and a separate customer section with distribution and control equipment.



Strut and Backboard



Commercial Pedestal

UL-listed as Industrial Control Equipment (File E113855)

Standard Features

- NEMA 3R rain-resistant, vandal-resistant cabinet of polyurethane powder coated steel (aluminum or stainless steel also available).
- UL-listed as enclosed industrial control equipment (UL508A).
- Isolated lockable and sealable utility metering and lug landing sections.
- Lockable customer section for distribution and control equipment with internal deadfront.
- Print pocket inside customer section door contains wiring schematics and installation instructions.
- Load centers are UL-listed for use with various manufacturers' circuit breakers.
- All stainless steel external hardware (screws, bolts, hinges, handles, hasps and sealing screws).

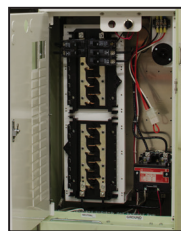
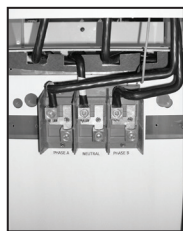

Please consult serving utility for their requirements prior to ordering or installing, as specifications and approvals vary by utility, and may require local electrical inspector approval. All installations must be installed by a licensed electrician and must comply with all national and local codes, laws and regulations. Milbank reserves the right to make changes in specifications and features shown without notice or obligation.

Enclosed Controls

Attractive | Easy-to-Install | Secure | Cost-Effective



Applications

These units are ideal for controlling and metering:

- Traffic signals and street lighting for municipalities.
- Power distribution for electric vehicle charging stations.
- Communication equipment such as cell towers and telephone vaults.
- Event power for fairs, outdoor markets, portable offices, holiday lights, etc.
- Outdoor lighting for athletic fields, tennis and basketball courts, parking lots, landscaping and subdivision entrances.

Available Factory-Installed Options

- Meter sockets: ring type or ringless, up to 400 Amps
- Main and branch breakers or T fuses
- Distribution: copper load centers and panelboards
- Clocks, timers and relays
- Photoelectric cells and controls
- Various power receptacles: pin and sleeve, twist lock or straight blade
- Contactors: lighting, definite purpose, motor starters
- Surge protection and lightning arresters
- Generator inlets with interlocked breakers
- Push button controls
- Thermostat controls, fans and heating strips
- Power blocks and Terminals blocks
- Steel, aluminum and plywood backboards
- Transformers
- Interlock devices for circuit breakers

Options

- Available in steel, aluminum (raw painted or anodized) or stainless steel construction with powder coated finish available in eight standard colors or special-ordered RAL colors.
- Available for applications up to 400 Amps, 120V, 208V, 240V, 277V, 480V - 1Ø or 3Ø.

Accessories

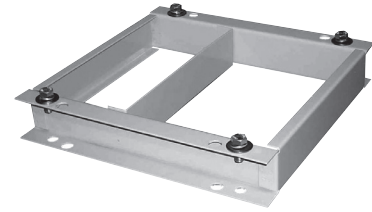

Pad-mount bases available for all pedestal sizes, inquire with your representative for details.

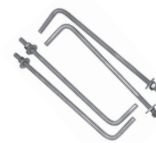

CP-ABK5/8

Anchor bolt kit
(includes four 5/8 - 13 x 18" anchor bolts)



105J

Fifth Terminals kit for use with ring type meter sockets



K3865

Fifth Terminals kit for use with ringless meter sockets



CP-TC7D

7-day time clock kit

CP-TC24H

24-hour time clock kit

CP-TCWIRE

Male 4-pin connector and wiring harness for use with time clocks other than above

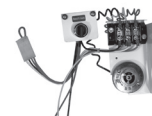

CP-PE-HOA-3POS

HOA switch for field installation

Please consult serving utility for their requirements prior to ordering or installing, as specifications and approvals vary by utility, and may require local electrical inspector approval. All installations must be installed by a licensed electrician and must comply with all national and local codes, laws and regulations. Milbank reserves the right to make changes in specifications and features shown without notice or obligation.



Main Load Center Commercial Pedestals | 1Ø3-wire 120/240V or 208Y/120V

Application: Remote site service for multiple loads

Milbank Main Load Center Commercial Pedestals are designed to handle the vast majority of all requirements in a standard, stocked configuration.

- All units feature a load center with a plug-on, back-fed main breaker.
- Standard units are equipped with with a 16 circuit load center in the 100 Amps or 24 circuit load center in 200 Amps models.
- Sub-feed lugs to allow feeding an external panel.

If your application requires turning loads on based on “dusk-to-dawn” requirements, be sure to see the Milbank Switched Load Center Commercial Pedestal products on the following page.

Features

These units include everything required for remote site service:

- Expandable: load centers allow for future expansion without costly modifications.
- All units feature a 200 Amps meter socket with optional field-installable fifth Terminals kit available.
- 22K Amps interrupting capacity (AIC) standard.
- Optional mounting base can be embedded in concrete for fast, easy installation.
- Separate sealable and lockable utility termination section.
- Separate sealable and lockable metering section.
- Separate sealable and lockable customer section with a load center for “always on” loads that include a main circuit breaker, 20 (125 or 200 Amps model) or 14 (100 Amps model) blank breaker spaces and a circuit directory to document configuration.



Please consult serving utility for their requirements prior to ordering or installing, as specifications and approvals vary by utility, and may require local electrical inspector approval. All installations must be installed by a licensed electrician and must comply with all national and local codes, laws and regulations. Milbank reserves the right to make changes in specifications and features shown without notice or obligation.

Enclosed Controls

Switched Load Center Commercial Pedestals

Switched Load Center Commercial Pedestals

1Ø3-wire 120/240V or 208Y/120V

Designed not only to provide power for various loads, but also to switch specific loads on and off under certain conditions. A photoelectric cell is used for these controlled loads, and an optional time clock is also available.

Features

These units include everything required for remote site service:

- Expandable: load centers allow for future expansion without costly modifications.
- All units feature a 200 Amps meter socket with optional field-installable fifth Terminals kit available.
- 22K Amps interrupting capacity (AIC) standard.
- Optional mounting base can be embedded in concrete for fast, easy installation.
- Separate sealable and lockable utility termination section.
- Separate sealable and lockable metering section.
- Separate sealable and lockable customer section with a control circuit including PE receptacle, Lexan® window, glare shield, Hand-Off-Auto (HOA) switch, contractor controlling a 16-circuit load center for controlled loads, a pre-mounted DIN rail and pre-wired connector to add an optional "plug-and-play" time clock kit for PE on and TC off operation and a circuit directory to document configuration.
- A load center for "always on" loads that includes a main circuit breaker, a control power circuit breaker, a switched load center main breaker, nine (125 or 200 Amps model) or 11 (100 Amps model) blank breaker spaces and a circuit directory to document configuration.

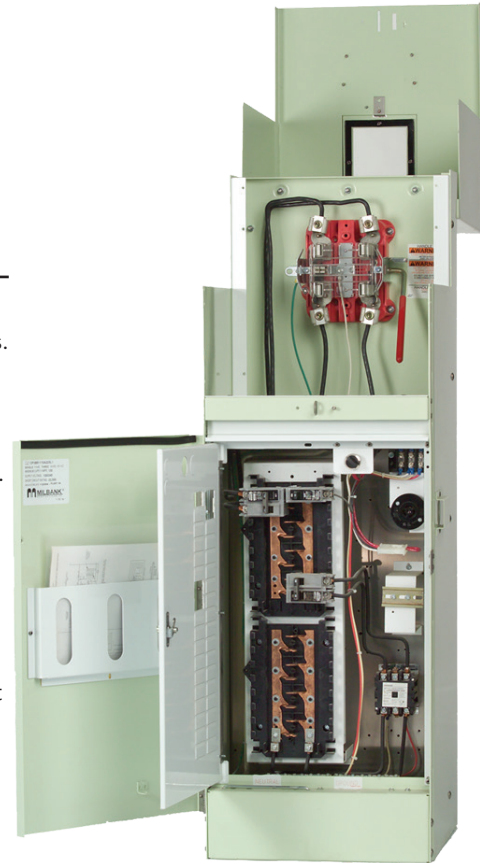

Ringless Lever Bypass shown

Applications



Traffic Signals

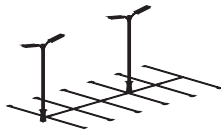

Parking Lots



Highways



Athletic Field Lighting

Please consult serving utility for their requirements prior to ordering or installing, as specifications and approvals vary by utility, and may require local electrical inspector approval. All installations must be installed by a licensed electrician and must comply with all national and local codes, laws and regulations. Milbank reserves the right to make changes in specifications and features shown without notice or obligation.





Designed to provide a weather- and vandal-resistant metered enclosure for various loads and distribution. Each pedestal has been designed to handle a wide range of applications using standard, stocked configurations including:

- Choice of a single main breaker or twin service disconnect breakers gives flexibility to the pedestal design.
- Optional distribution with feed-through lugs below the service disconnect breakers allows the pedestal to handle numerous applications.
- Typical applications include remote homes where the metering is best located at the curb side or other remote area. The pedestal can also provide power to a secondary residence, on-site business, workshop, irrigation, lighting, security or other secondary load.

Features

These units include everything required for remote service:

- Main circuit breaker or dual service disconnects.
- Expandable: load center units that allow for future expansion without costly modifications.
- Optional mounting base can be embedded in concrete for fast, easy installation.
- Separate sealable and lockable utility termination section with lug termination.
- Separate sealable and lockable metering section.
- Separate sealable and lockable customer section with a circuit directory and a print pocket to hold all documentation.
- Meter socket options include ring type with bypass studs, ringless with heavy duty lever bypass, or K-type bolt-on.

Applications



Commercial Job Sites



Remote Site for Residential and Commercial Locations



Please consult serving utility for their requirements prior to ordering or installing, as specifications and approvals vary by utility, and may require local electrical inspector approval. All installations must be installed by a licensed electrician and must comply with all national and local codes, laws and regulations. Milbank reserves the right to make changes in specifications and features shown without notice or obligation.

Enclosed Controls

Surface-Mount Compact Design

Surface-Mount Enclosed Controls

Originally developed for small cellular communications, the surfacemount enclosed control offers the flexibility of larger enclosed controls products with a smaller footprint and several mounting options.

Features

- Mounting options allow for easy installation.
- Overhead and underground entry and exit, all in one unit.
- Meter and components in one enclosure.
- Custom component configurations and UL-listing covers all internal components on the UL508A and UL891.
- Can be mounted on multiple surfaces including:
 - walls.
 - poles (narrow profile will have minimal extension past sides).
 - H frames (strut).
- Multiple bypass options available.
- Monitoring options available.
- Optional powder coating in Milbank standard EC color or custom color.



Benefits

- Smaller footprint
- Flood resistant
- Eliminates need for connecting components
 - Wire in - Wire Out

Applications



Communications
Power Distribution



Lighting
Control

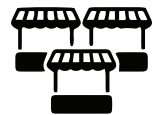

Streetscape
Power Distribution

Please consult serving utility for their requirements prior to ordering or installing, as specifications and approvals vary by utility, and may require local electrical inspector approval. All installations must be installed by a licensed electrician and must comply with all national and local codes, laws and regulations. Milbank reserves the right to make changes in specifications and features shown without notice or obligation.



Battery Backup Commercial Pedestals

This product is specifically designed to provide battery backup power to a variety of loads and to conditionally switch specific loads on and off. It can use a photoelectric cell or time clock to control lighting circuits. Battery backup pedestals have options for both metered and unmetered power distribution. These pedestals are highly versatile and can handle the vast majority of today's backup power requirements. Its 19" rack design allows for easy adjustment of shelves to accommodate batteries, DC to AC inverters, transfer switches and other related equipment.

Features

- Works with 100 through 320 Amps meter sockets with the option of either a ring type socket (conforms to EUSERC 308) with or without test/bypass blocks or a heavy duty ringless socket with lever bypass.
- Separate sealable utility termination compartment.
- An isolated separate customer section with service disconnects, power distribution options and power control.
- 19" wide rack in customer compartment for easy layout of equipment.
- Includes trays to accommodate required batteries.
- Thermostat with cooling fan.
- Filtered louvers for heat rise flow through ventilation.
- Three point door latch (key or padlockable).

Note

- May require customization based on regional requirements.

Applications



Camera and Security Locations

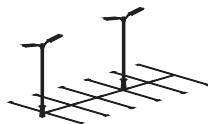

Parking Lots



Traffic Signals



Communications Power Distribution

Options

- | | | |
|--|--|---|
| <ul style="list-style-type: none"> • Manual bypass switch • Transfer switch for generator power backup • Generator inlet receptacles 30 Amps through 200 Amps • Pad-lockable provision for receptacles | <ul style="list-style-type: none"> • Police access door • Metered load center distribution • Unmetered load center distribution • Photo electric controls (for street lighting) • Time clocks • HOA switches | <ul style="list-style-type: none"> • Contactors • GFCI duplex receptacles • Thermostat for heating control • Heating pads or elements • Roll out shelves for batteries • Surge arresters and lighting arresters |
|--|--|---|



Please consult serving utility for their requirements prior to ordering or installing, as specifications and approvals vary by utility, and may require local electrical inspector approval. All installations must be installed by a licensed electrician and must comply with all national and local codes, laws and regulations. Milbank reserves the right to make changes in specifications and features shown without notice or obligation.

Power Transfer Commercial Pedestals



Power transfer commercial pedestals provide metered or unmetered AC power, distribution, surge suppression, mechanical interlock and standby generator receptacles — in one compact pedestal.

Features

- 120/240V 1Ø3W through 277/480V 3Ø4W ratings
- Metered or unmetered units
- Choice of EUSERC ring type or ringless meter sockets
- 60 Amps through 400 Amps ratings
- Pad-lockable, isolated utility compartments
- 20 Amps GFCI convenience receptacle
- Lockable recessed generator receptacle door
- Utility and generator indicator light options
- All stainless steel hardware
- Galvanized steel, aluminum or stainless steel cabinet options
- Custom designs available

Note

- May require customization based on regional requirements.

Applications



Traffic Signals



Pump and Lift Stations



Communications Power Distribution

Please consult serving utility for their requirements prior to ordering or installing, as specifications and approvals vary by utility, and may require local electrical inspector approval. All installations must be installed by a licensed electrician and must comply with all national and local codes, laws and regulations. Milbank reserves the right to make changes in specifications and features shown without notice or obligation.



Enclosed Controls

Slimline Commercial Pedestals



Provides a sleeker, smaller footprint with wireway access on the side of the unit, rather than the back. This allows maximum flexibility to install the pedestal anywhere physical space is at a premium.

Providing unmetered AC power, distribution, surge suppression, mechanical interlock and standby generator receptacle — all in a neat, compact pedestal.

Features

- Available for 100 or 200 Amps.
- Vandal-resistant, secure and attractive design.
- Customer compartment with distribution and control equipment with swing deadfront door, secured with both a hasp/latch and draw latch outer door.
- Utility metering compartment protected with a hinged hood, increasing resistance to meter vandalism.
- Slim design creates a smaller footprint.
- Wireway located on left side of pedestal for utility incoming wire, allowing pedestal to be mounted with back as close as 14" to walls or structures.
- Available in 12" and 20" widths and 50" and 63" (metered) and 43" (unmetered) heights. Includes a print pocket for plans and drawings.
- Voltage range is between 120V and 480V.
- Compatible with both ringless and ring type meter sockets, 4–7 terminals.
- Available in a wide array of colors, including but not limited to all ANSI powder coated paint colors upon request.
- Pedestal mounting base option saves time and labor to install on a cement pad—no anchor bolts required.
- Powder coated G90 galvanized steel or aluminum; raw, anodized or powder coated, as well as stainless steel exterior options.



With no need to coordinate, buy or wait for concrete, **direct bury pedestals** offer many advantages and can cut installation time down to less than an hour. Traditional direct bury pedestals can be awkward to transport and can only be used in a direct bury application. Milbank's modular design offers flexibility and convenience for distributors and contractors alike.



Notes

- May require customization based on regional requirements.
- Direct bury pedestals are only available for 12" pedestals. Constructed with 14-gauge steel.



Please consult serving utility for their requirements prior to ordering or installing, as specifications and approvals vary by utility, and may require local electrical inspector approval. All installations must be installed by a licensed electrician and must comply with all national and local codes, laws and regulations. Milbank reserves the right to make changes in specifications and features shown without notice or obligation.

Circuit Breakers

UQFP Plug-In Series and UQFB Bolt-On Series

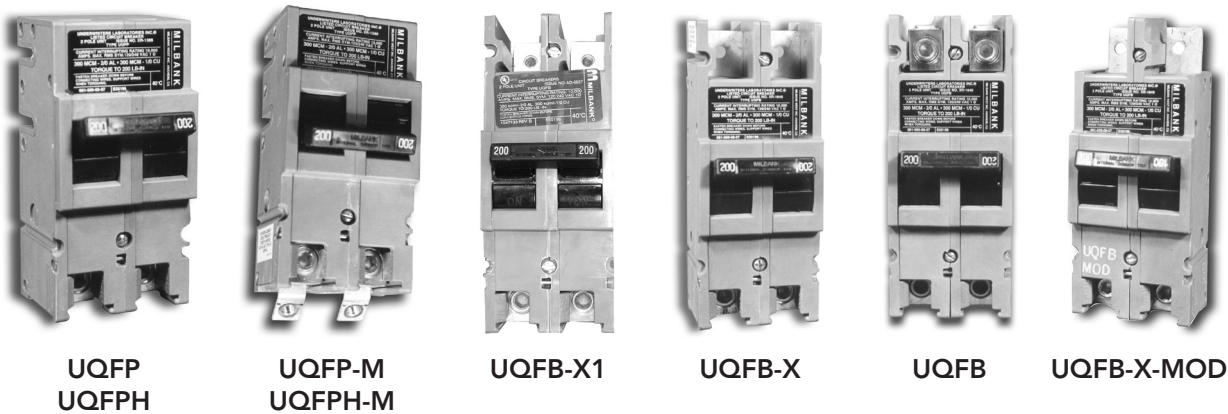

200 Amps Frame | Plug-In | 10K AIC and 22K AIC | Two-Pole - Common Trip

Amps	10K AIC Plug-In	22K AIC Plug-In	10K AIC Plug-In	22K AIC Plug-In	Wire Range	
					CU	AL
100	UQFP-100	UQFPH-100	UQFP-M-100	UQFPH-M-100	#3-#1	#1-1/0
125	UQFP-125	UQFPH-125	UQFP-M-125	UQFPH-M-125	#3-#1	#1-1/0
150	UQFP-150	UQFPH-150	UQFP-M-150	UQFPH-M-150	1/0-300	2/0-300
175	UQFP-175	UQFPH-175	UQFP-M-175	UQFPH-M-175	1/0-300	2/0-300
200	UQFP-200	UQFPH-200	UQFP-M-200	UQFPH-M-200	1/0-300	2/0-300

200 Amps Frame | Bolt-On | 10K AIC and 22K AIC | Two-Pole - Common Trip

Amps	10K AIC Bolt-On	22K AIC Bolt-On	10K AIC Bolt-On	22K AIC Bolt-On	Wire Range	
					CU	AL
100	UQFB-100	UQFBH-100	UQFB-100-X1	UQFBH-M-100	#3-#1	#1-1/0
125	UQFB-125	UQFBH-125	UQFB-125-X1	UQFBH-M-125	#3-#1	#1-1/0
150	UQFB-150	UQFBH-150	UQFB-150-X1	UQFBH-M-150	1/0-300	2/0-300
175	UQFB-175	UQFBH-175	UQFB-175-X1	UQFBH-M-175	1/0-300	2/0-300
200	UQFB-200	UQFBH-200	UQFB-200-X1	UQFBH-M-200	1/0-300	2/0-300

Notes

- **UL-listed:** For use with 60°C or 75°C wire.
- **UQFP:** For parallel main circuit breaker applications.
- **UQFP-M:** For series main circuit breaker applications. Split load tab features allow for feed-through capability.
- **UQFB:** (2) 1/0-300 lugs provided on load and line side (cable-in, cable-out).
- **UQFB3:** Three-pole available. Consult factory.
- **UQFB-X:** (2) 1/0-300 lugs provided on load side and (2) line bar bus connections on line side.
- **UQFB-M:** For series main circuit breaker applications. Split load tab features allow for feed-through capability.
- **UQFB-X-MOD:** Replacement circuit breaker with line barriers removed.

Please consult serving utility for their requirements prior to ordering or installing, as specifications and approvals vary by utility, and may require local electrical inspector approval. All installations must be installed by a licensed electrician and must comply with all national and local codes, laws and regulations. Milbank reserves the right to make changes in specifications and features shown without notice or obligation.



QP (small frame) and QN (large frame) | 120/240V

15–125 Amp Breaker
Plug-In Type | 1" Per Pole

Amps	Poles	10K AIC Plug-In	22K AIC Plug-In
15	Single	Q115	Q115H
15	Double	Q215	Q215H
20	Single	Q120	Q120H
20	Double	Q220	Q220H
25	Single	Q125	Q125H
25	Double	Q225	Q225H
30	Single	Q130	Q130H
30	Double	Q230	Q230H
35	Single	Q135	Q135H
35	Double	Q235	Q235H
40	Single	Q140	Q140H
40	Double	Q240	Q240H
50	Single	Q150	Q150H
50	Double	Q250	Q250H
60	Single	Q160	Q160H
60	Double	Q260	Q260H
70	Single	Q170	Q170H
70	Double	Q270	Q270H
80	Double	Q280	Q280H
90	Double	Q290	Q290H
100	Double	Q2100	Q2100H
125	Double	Q2125	Q2125H



QN2200H



QN2200RH



Q250

200 Amp Frame | Plug-In | 10K AIC and 22K AIC | two-pole - Common Trip

Amps	10K AIC Plug-In	22K AIC Plug-In	Handle Location	Wire Range	
				CU	AL
150	QN2150	QN2150H	Left facing	#4-300	#4-300
200	QN2200	QN2200H	Left facing	#4-300	#4-300
150	QN2150R	QN2150RH	Right facing	#4-300	#4-300
200	QN2200R	QN2200RH	Right facing	#4-300	#4-300

Notes

- **Breakers:** Load connectors supplied with breakers.
- **UL-listed:** For use with 60°C or 75°C wire.
- **Wire sizes:** Wire sizes shown are lug capacity. Consult NEC Article #310 for specific wire sizes.



Please consult serving utility for their requirements prior to ordering or installing, as specifications and approvals vary by utility, and may require local electrical inspector approval. All installations must be installed by a licensed electrician and must comply with all national and local codes, laws and regulations. Milbank reserves the right to make changes in specifications and features shown without notice or obligation.

Hubs and Closing Plates

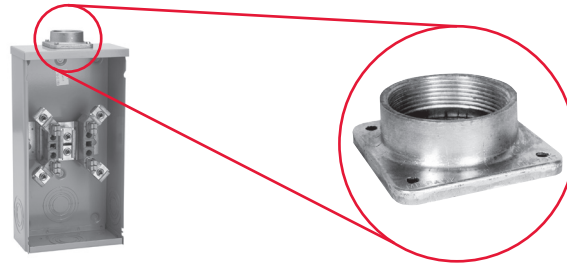
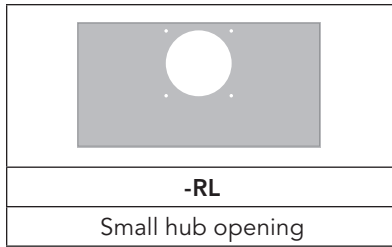

-WL A7514	-YL A7515	-ZL A7516	-DL A7517	-EL A7518	-XL A7551
1" hub	1¼" hub	1½" hub	2" hub	2½" hub	Small closing plate

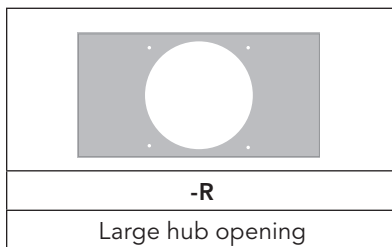

-F A8110	-G A8111	-H A8112	-X A9064	-RRL S8324
3" hub	3½" hub	4" hub	Large closing plate	Large hub opening adapted to small hub opening

Notes

- **Suffix:** Add to catalog number for factory installation of hub.
- **Packaging:** Individually packed units for field installation.
- **Abbreviations:** H.O. (hub opening), C.P. (closing plate).

Please consult serving utility for their requirements prior to ordering or installing, as specifications and approvals vary by utility, and may require local electrical inspector approval. All installations must be installed by a licensed electrician and must comply with all national and local codes, laws and regulations. Milbank reserves the right to make changes in specifications and features shown without notice or obligation.



Connector Kits, Closing Kits and Sealing Rings

Connector Kits | For Use with 3/8"-16 Stud Type Units Only

Single			Twin		
Suffix	Part #	(3 per set) - 1Ø	Suffix	Part #	(3 per set) - 1Ø
K1	K1539	#6-350	K2	K1350	#6-350
K3	K1540	#4-600 or (2) #1/0-250	K2L	K1350L	#6-350 (non-rotating)
K3L	K1540L	#4-600 or (2) #1/0-250 (non-rotating)*	K4	K1541	#4-600
Suffix	Part #	(4 per set) - 3Ø	Suffix	Part #	(4 per set) - 3Ø
K5	K3082	#6-350	K6	K3442	#6-350
K7	K3441	#4-600 or (2) #1/0-250*	K8	K3083	#4-600

Bypass Link



K8180 (sold in pairs)

Notes

Consult factory for proper connector kits for studded meter sockets.

* For (2) 1/0-250, conductors must be of same size.

Closing Covers

Meter Closing Plate (Ring Type/Ringless)	Metal Closing Plate (For Ringless Sockets)
6003 - Gray Plastic	CP-21
6116 - Clear Plastic	

Generator Interlock

K5815 - Large QN with small frame Q
K5820 - Large frame QN with large frame QN
K5830 - Small frame Q to small frame Q

Disconnect Sleeve

M5-144
Do NOT use with lever bypass sockets

Pedestal Raceway Stake Kit

	K3235
S2291-TO	Suitable for use with pedestals for extra support

Anti-Inversion Clip



K4802

Touch-Up Paint

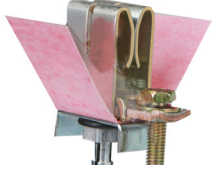
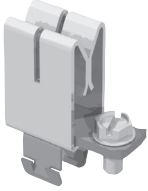

A-GP - Light Gray

Fifth Terminal and Tap Connectors

Fifth Terminals

		
5T8K2 - 100-200 Amps "Plug-In"	K5T - 200 Amps (Block with Square Hole)	K3865 - Heavy Duty Jaw Clamping (K3866 without Neutral Wire)

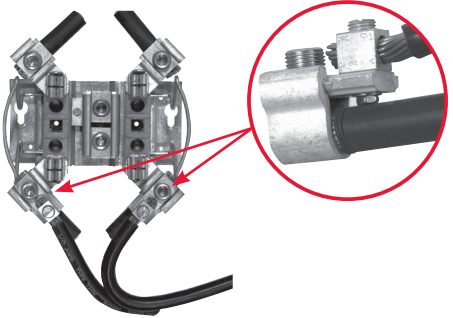
Tap Connectors (3 per set)

	<p>Replaces the load or line side slide-in nut assembly on Milbank 200 Amps sockets. Allows for a 100 Amps tap location in addition to the #6-350 kcmil load-side connector.</p> <p>K5022 includes safety barrier extensions for applications over 300 VAC. Three lugs per kit.</p>	
	<p>K4977-INT - Internal Hex</p> <p>K4977-EXT - External Hex</p> <p>K5022-INT - Internal Hex (set of 4 w/ barrier)</p>	<p>K1190 (For factory-installed triplex ground, add suffix -TG to catalog number)</p>

Triplex Ground

100 Amps Blocks (single sockets only)

BL7474 - Block Assembly
BL7499 - Horn Bypass Block Assembly
Z904486-AO - Slotted Nut Assembly
Z903274-AO - Horn Bypass Nut Assembly
Z802965-AC - Neutral without Nut
Z901925-AC - Hex Nut Set Screw

200 Amps Blocks (single sockets only)

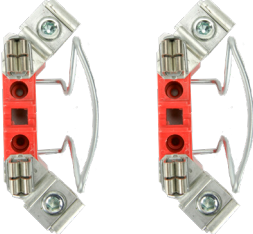
K4527 - Internal Hex Block Assembly (w/ meter support)
K4528 - External Hex Block Assembly (w/ meter support)
K4529 - Internal Hex Horn Bypass Block Assembly (w/ meter support)
K4530 - External Hex Horn Bypass Block Assembly (w/ meter support)
Z916265-AO - Internal Nut Assembly
Z916264-AO - Neutral without Nut
Z814898-AC - Neutral without Nut

Please consult serving utility for their requirements prior to ordering or installing, as specifications and approvals vary by utility, and may require local electrical inspector approval. All installations must be installed by a licensed electrician and must comply with all national and local codes, laws and regulations. Milbank reserves the right to make changes in specifications and features shown without notice or obligation.





NEMA Commercial Enclosures

Milbank's line of commercial enclosures includes the full gamut of styles and sizes: everything from junction boxes to transformer cabinets, telephone cabinets, to wireways.

Type-1 Enclosures

Milbank's NEMA Type-1 enclosures are designed for indoor use to provide a degree of protection to personnel against access to hazardous parts and to provide a degree of protection of the equipment inside the enclosure against ingress of solid foreign objects, such as falling dirt.

NEMA 3R Enclosures

Milbank's NEMA 3R enclosures are designed for either indoor or outdoor use to provide a degree of protection from harmful effects on the equipment due to the ingress of water (rain, sleet, snow) or prevent damage from the external formation of ice on the enclosure.

Wireways

Milbank's wide range of wireways are available in many styles and sizes and a varied range of fittings allow smooth transitions to and from many manufacturers' products.



Please consult serving utility for their requirements prior to ordering or installing, as specifications and approvals vary by utility, and may require local electrical inspector approval. All installations must be installed by a licensed electrician and must comply with all national and local codes, laws and regulations. Milbank reserves the right to make changes in specifications and features shown without notice or obligation.

DIAGRAM A
1Ø2W with 1 P.T. and 1 C.T.
Single Stator Meter (2W1Ø) - Form 3S
5T Socket, Test Switch #TS04-0101

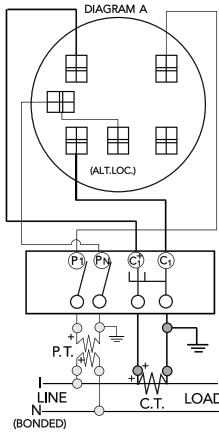

DIAGRAM B
1Ø3W with 1 C.T.
Single Stator Meter (2W1Ø) - Form 3S
5T Socket, Test Switch #TS04-0101

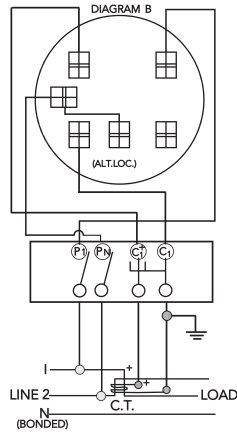

DIAGRAM C
1Ø3W with 2 C.T.'s
Single Stator Meter (3W1Ø) - Form 4S
6T Socket, Test Switch #TS07-0105

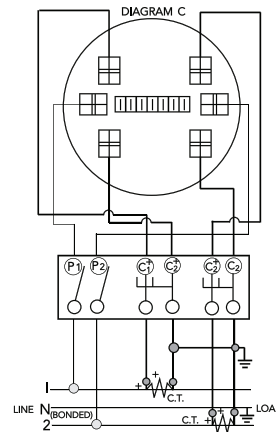

DIAGRAM D
1Ø3W or 3W Network with 2 C.T.'s
2 Stator Meter - Form 5S
8T Socket, Test Switch #TS07-0105

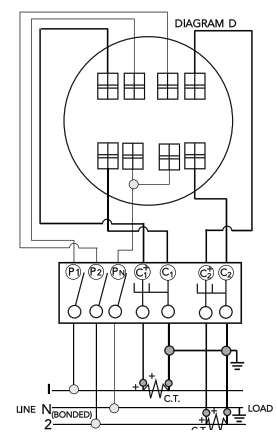

DIAGRAM E
3Ø3W "Δ" with 2 P.T.'s and 2 C.T.'s
2 Stator Meter - Form 5S
8T Socket, Test Switch #TS07-0105

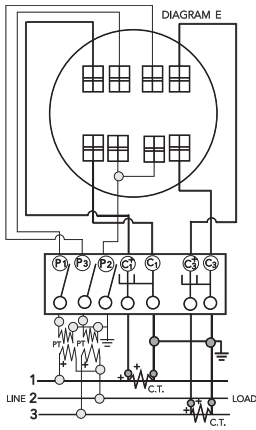

DIAGRAM F
3Ø3W "Δ" with 2 C.T.'s
2 Stator Meter - Form 5S
8T Socket, Test Switch #TS07-0105

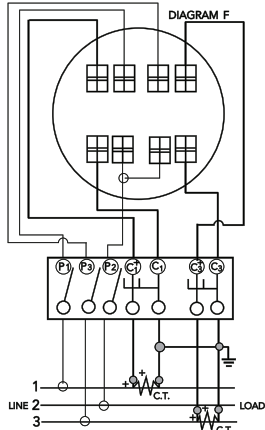

DIAGRAM G
3Ø4W "Y" with 3 C.T.'s
2 1/2 Stator Meter - Form 6S
13T Socket, Test Switch #TS10-0109

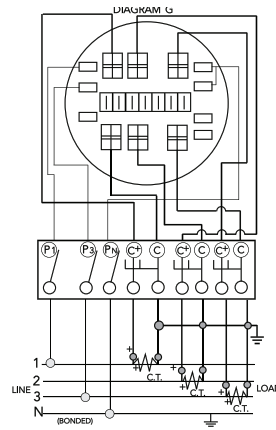

DIAGRAM H
3Ø4W "Y" with 2 P.T.'s and 3 C.T.'s
2 1/2 Stator Meter - Form 6S
13T Socket, Test Switch #TS10-0109

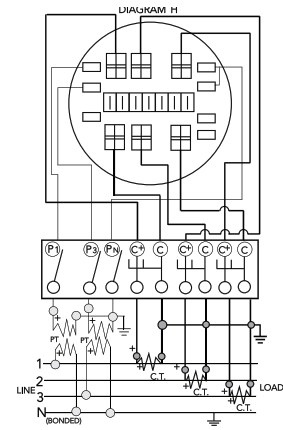

DIAGRAM I
3Ø4W "Y" or "Δ" with 3 C.T.'s
"Y" 3 Stator Meter - Form 9S
"Δ" 2 Stator Meter - Form 8S
13T Socket, Test Switch #TS10-0109

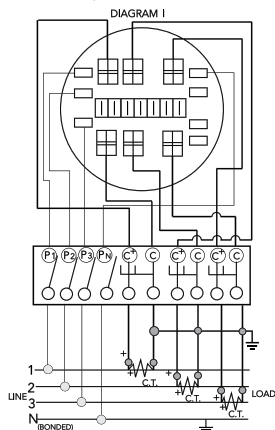
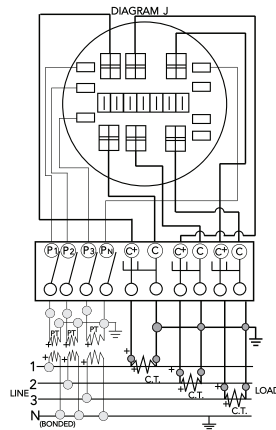

DIAGRAM J
3Ø4W "Y" with 3 P.T.'s and 3 C.T.'s
3 Stator Meter - Form 9S
13T Socket, Test Switch #TS10-0109



Prewiring

If standard factory prewiring is required, refer to wiring diagrams on this page. Determine appropriate diagram and send a copy with order. If custom factory prewiring is required, specify on order. Be sure to include meter socket catalog number, test switch make and catalog number, meter form number and provide a copy of your wiring diagram.

Please consult serving utility for their requirements prior to ordering or installing, as specifications and approvals vary by utility, and may require local electrical inspector approval. All installations must be installed by a licensed electrician and must comply with all national and local codes, laws and regulations. Milbank reserves the right to make changes in specifications and features shown without notice or obligation.



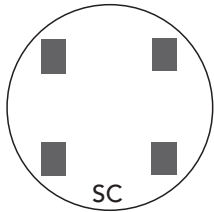

2 and 3-WIRE FORMS
1S & 2S

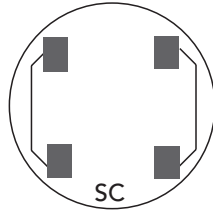

2 and 3-WIRE FORMS
1S & 2S with bypass

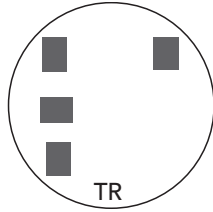

2-WIRE FORM 3S
5th Term. 9 o'clock

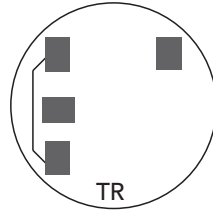

2-WIRE FORM 3S
with bypass

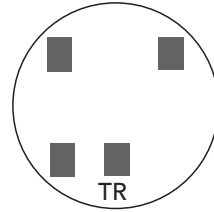

2-WIRE FORM 3S
5th Term. 6 o'clock

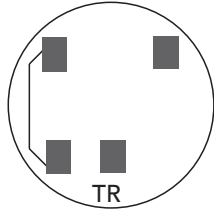

2-WIRE FORMS 3S
with bypass

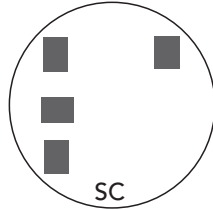

2 ELEMENT 3-WIRE
NETWORK FORM 12S
5th Term. 9 o'clock

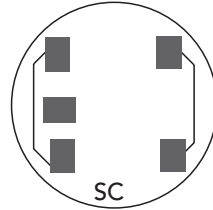

2 ELEMENT 3-WIRE
NETWORK FORM 12S
5th Term. 9 o'clock

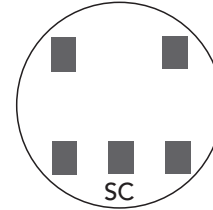

2 ELEMENT 3-WIRE
NETWORK FORM 12S
5th Term. 6 o'clock

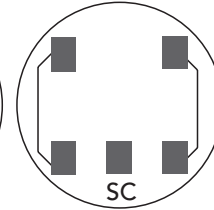

2 ELEMENT 3-WIRE
NETWORK FORM 12S
with bypass
5th Term. 6 o'clock

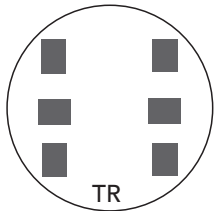

3-WIRE FORMS 4S

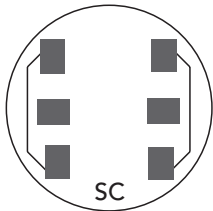

3-WIRE FORM 4S
with bypass

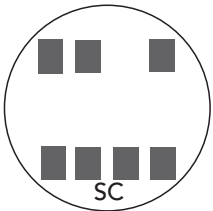

2 or 3 ELEMENT
3Ø4W Y or Δ
Y FORM 14S

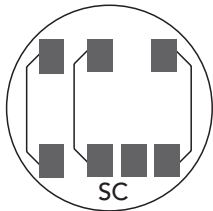

2 or 3 ELEMENT
3Ø4W Y or Δ
with bypass

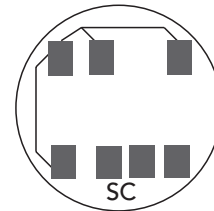

2 ELEMENT 3Ø4W Y or
Δ Y FORM 7S Δ FORM 24S
with bypass

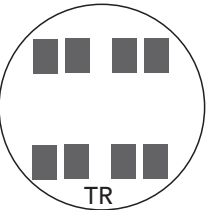

2 ELEMENT
2Ø3W, 2Ø4W, 3Ø3W
FORM 5S

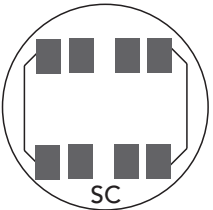

2 ELEMENT
2Ø3W, 2Ø4W, 3Ø3W
FORM 5S with bypass

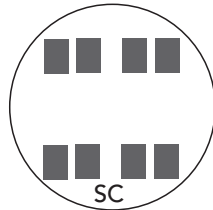

2 ELEMENT
2Ø3W, 2Ø4W, 3Ø3W
FORM 13S

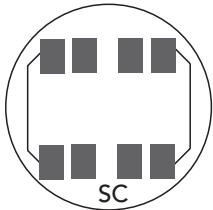

2 or 3 ELEMENT
2Ø3W, 2Ø4W, 3Ø3W
FORM 13S with bypass

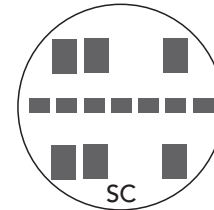

2 or 3 ELEMENT 3Ø4W
Y or Δ Y FORM 9S
Δ FORM 8S

TR= Transformer Rated
SC= Self-Contained

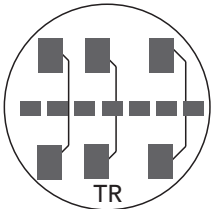

2 or 3 ELEMENT
3Ø3W, Y or Δ
FORM 8S & 9S with bypass

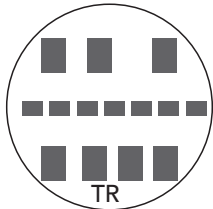

2 ELEMENT
3Ø4W Y
FORM 6S

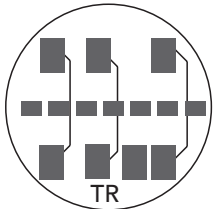

2 ELEMENT
3Ø4W Y FORM 6S
with bypass



Please consult serving utility for their requirements prior to ordering or installing, as specifications and approvals vary by utility, and may require local electrical inspector approval. All installations must be installed by a licensed electrician and must comply with all national and local codes, laws and regulations. Milbank reserves the right to make changes in specifications and features shown without notice or obligation.

Reference Information

MAXIMUM NUMBER OF CONDUCTORS IN CONDUIT

Table from 2008 NEC Code Reference: Rigid Metal Conduit

Type	Conductor Size (AWG/kcmil)	Conduit Trade Sizes (Inches)									
		1/2	3/4	1	1 1/4	1 1/2	2	2 1/2	3	3 1/2	4
THHN, THWN, THWN-2	12	9	16	26	46	62	102	146	225	301	387
	10	6	10	17	29	39	64	92	142	189	244
	8	3	6	9	16	22	37	53	82	109	140
	6	2	4	4	12	16	27	38	59	79	101
	4	1	2	4	7	10	16	23	36	48	62
	3	1	1	3	6	8	14	20	31	41	53
	2	1	1	3	5	7	11	19	26	34	44
	1	1	1	1	4	5	8	12	19	25	35
	1/0	1	1	1	3	4	7	10	16	21	27
	2/0	0	1	1	2	3	6	8	13	18	23
XHH, XHHW, XHHW-2	3/0	0	1	1	1	3	5	7	11	15	19
	4/0	0	1	1	1	2	4	6	9	12	16
	4	1	2	4	7	10	16	24	37	49	63
	2	1	1	3	5	7	12	17	26	35	45
	1/0	1	1	1	3	4	7	10	16	22	28
	2/0	0	1	1	2	3	6	9	13	18	23
	4/0	0	1	1	1	2	4	6	9	12	16
	250	0	0	1	1	1	3	5	7	10	13
350	0	0	1	1	1	2	3	6	7	10	
500	0	0	0	1	1	1	2	4	5	7	
750	0	0	0	0	1	1	1	3	4	5	

This table is for concentric stranded conductors only. For cables with compact conductors refer to NEC. Refer to latest NEC Code or Local Codes for updated requirements.

SAMPLE RATING LABEL

CATALOG NUMBERS U5952 & U5953
100A MAXIMUM, 120/240 VAC SINGLE PHASE, THREE WIRE
RAINPROOF NEMA TYPE 3R

SHORT CIRCUIT CURRENT RATING IS 10,000 RMS SYMMETRICAL AMPERE AT 240 VAC MAXIMUM, BUT IS LIMITED TO THE LOWEST SHORT CIRCUIT CURRENT RATING OF ANY INSTALLED CIRCUIT BREAKER. WATTHOUR METER NOT INCLUDED IN SHORT CIRCUIT CURRENT RATING. REPLACEMENT CIRCUIT BREAKER MUST BE THE SAME TYPE AND RATING. USE SIEMENS QP, QT; CUTLER-HAMMER QP, BD, BR; SQUARE D HOMELINE; G.E. TQ, THQ, THL.

LINE NEUTRAL
LOAD NEUTRAL
LINE NEUTRAL
GROUND

SUITABLE FOR USE AS RECREATIONAL VEHICLE SITE SUPPLY EQUIPMENT

UNDERGROUND FEED ONLY

ON TRIP OFF

TO RESET BREAKER MOVE TO "OFF" THEN TO "ON"

DANGER
HAZARD OF ELECTRICAL SHOCK OR BURN
TURN OFF POWER
SUPPLYING THIS EQUIPMENT BEFORE WORKING INSIDE

WIRE TERMINAL INFORMATION USE AL-CU CONDUCTORS		
TERMINAL	WIRE RANGE	TORQUE LB-IN
LINE AND LINE NEUTRAL	350 kcmil - # 6	250
GROUND CONNECTOR	2/0 AWG - #14 AWG	120
LOAD NEUTRAL SLOTTED HEAD (LARGE HOLE)	14 - 10	35
	8	40
	6 - 4	45
LOAD NEUTRAL SLOTTED HEAD (SMALL HOLE)	3 - 1/0	50
	14 - 10	20
	8	25
	6	35

SHIPPING TENDS TO LOOSEN BOLTED CONNECTIONS. CHECK AND TIGHTEN ALL HARDWARE BEFORE ENERGIZING UNIT.

SIZE OF FIELD INSTALLED CONDUCTORS SHALL BE 60° OR 75° C SIZED TO 60° C RATING FOR 110 AMPS OR LESS AND 75° C SIZED TO 75° C FOR 125 AMPS AND ABOVE.

* ALLOWABLE AMPACITIES OF INSULATED COPPER & ** ALUMINUM CONDUCTORS (3W IN CONDUIT) 75° C (167° F)

A		AL or **CU-Clad AL	
A	B	A	B
18	—	—	—
16	—	—	—
14	20†	—	—
12	25†	12	20†
10	35†	10	30†
8	50	8	40
6	65	6	50
4	85	4	65
3	100	3	75
2	115	2	90
1	130	1	100
1/0	150	1/0	120
2/0	175	2/0	135
3/0	200	3/0	155
4/0	230	4/0	180
250	255	250	205
300	285	300	230
350	310	350	250
400	335	400	270
500	380	500	310
600	420	600	340
700	460	700	375
750	475	750	385

A = Size: AWG/MCM
***B** = Ampere Rating for Insulation Types:
FEPW, RH, RHW, THW, THWN, XHHW, USE, 2W.
****C** = Ampere Rating for Insulation Types:
RH, RHW, THW, THWN, XHHW, USE (Per NEC table 310-16)

AMPACITY CORRECTION FACTORS

Ambient Temp. C°	Correction Factor	Ambient Temp. F°
21 - 25	1.05	70 - 77
25 - 30	1.00	78 - 86
31 - 35	.94	87 - 95
36 - 40	.88	96 - 104
41 - 45	.82	105 - 113
46 - 50	.75	114 - 122
51 - 55	.67	123 - 131
56 - 60	.58	132 - 140
61 - 65	.33	141 - 158

GANG SOCKET OVERALL AMPACITIES

# of Meter Pos.	100A/Pos. Ampacity	125A/Pos. Ampacity	150A/Pos. Ampacity	200A/Pos. Ampacity
2	200A	200A	200A	200A #
3	200A	225A	225A	270A
4	200A	250A	270A	360A
5	225A	285A	338A	450A
6	270A	330A	396A	528A

Overall Ampere ratings of UL-listed Milbank multiple position meter sockets are based on **2008 NEC Handbook Article 220-84** and **ANSI / UL-414** (except where restricted by line connector size). These requirements provide for a diversity factor / demand factor being utilized in determining the overall (main bus / lug) rating of a gang socket. All Milbank UL-listed gang sockets meet or exceed these diversity factor/demand and factor requirements. Standard overall Ampacity ratings for UL-listed and non-UL-listed gang sockets are as shown in the chart below. Ampere ratings of meter sockets are based on the meter socket being wired with 75° C insulated wire conductor, sized in accordance with **Table 310-16** of the **National Electric Code**.

† Unless otherwise permitted elsewhere in the Code, the overcurrent protection for conductor types marked with an obelisk (†) shall not exceed 15 Amps for 14 AWG, 20 Amps for 12 AWG, and 30 Amps for 10 AWG copper; or 15 Amps for 12 AWG and 25 Amps for 10 AWG aluminum and copper-clad aluminum after any correction factors for ambient temperature and number of conductors have been applied.

Some constructions are rated at 400 Amps overall (1252). Contact your sales representative for more information. Refer to latest NEC Code or Local Codes for updated requirements.

Please consult serving utility for their requirements prior to ordering or installing, as specifications and approvals vary by utility, and may require local electrical inspector approval. All installations must be installed by a licensed electrician and must comply with all national and local codes, laws and regulations. Milbank reserves the right to make changes in specifications and features shown without notice or obligation.



Important Note

In addition to national and local electrical codes, many utilities have specific requirements for metering equipment. Always consult the serving utility for their specifications and requirements prior to ordering or installing Milbank meter mounting equipment.

Before Energizing

1. Give equipment a thorough visual examination to determine that:
 - a) No shipping or installation damage exists.
 - b) Proper clearances have been maintained.
 - c) All connections have been made.
 - d) Equipment is clean and dry.
2. Make a thorough examination to:
 - a) Verify tightness of all bolted connections (see table below).
 - b) Manually operate all circuit breakers, switches, relays, etc.
 - c) Check rigidity of all mountings, bus bars and components.
 - d) Use test equipment to check continuity of circuitry and integrity of insulation.
3. All switches and circuit breakers should be in the OFF position.
4. Verify that manual meter bypass (if applicable) is in non-bypass position.
5. Install cover and/or close doors.
6. If installation is not being energized at this time, follow "after-energizing" steps listed below. These steps will secure the installation in case of accidental energization.

When Energizing

1. Use caution and follow established safety procedures:
 - a) Wear safety apparel.
 - b) Use safety equipment.
 - c) Take action to prevent injury to yourself and others in the event of failure of the installation.
 - d) Take action to prevent/decrease damage to property in the event of failure of the installation.
 - e) If you are unsure how to safely energize the installation, get someone who is knowledgeable to do it.

After Energizing

1. Secure the installation:
 - a) To prevent accidental contact with energized parts, cover all openings with approved filler devices.
 - b) To prevent unauthorized access, secure all covers and/or doors with approved security devices.
 - c) Attach/post information to advise others of potential hazards associated with the installation.

Recommended Torque for General Applications*

Nominal Size	Joint Description		Head Type	Torque (Inch Lbs.)
	Screw	Nut		
10	Brass	Brass Nut or Extruded Hole	All	20-25 inch lbs.
10	Steel	Copper or Aluminum Busbar ≤ 1/8"	All	25-30 inch lbs.
10	Steel	Steel Nut or Extruded Hole; CU or AL Busbar > 1/8"	All	30-35 inch lbs.
12	Steel	Aluminum Extruded Hole	All	30-35 inch lbs.
12	Steel	Steel Nut or Extruded Hole	All	40-50 inch lbs.
1/4	Steel	Aluminum Extruded Hole	All	40-50 inch lbs.
1/4	Steel	Steel Nut or Extruded Hole; CU or AL Busbar	All	50-60 inch lbs.
5/16	Steel	Aluminum Extruded Hole	Hex	60-70 inch lbs.
5/16	Steel	Steel Nut or Extruded Hole; CU or AL Busbar	Hex	100-150 inch lbs.
3/8	Steel	Steel Nut	Hex	150-200 inch lbs.
1/2	Steel	Steel Nut	Hex	200-250 inch lbs.

* Interior labels typically indicate the required torque for wire connectors and studs, and should be referenced first.
CU: Copper
AL: Aluminum



Please consult serving utility for their requirements prior to ordering or installing, as specifications and approvals vary by utility, and may require local electrical inspector approval. All installations must be installed by a licensed electrician and must comply with all national and local codes, laws and regulations. Milbank reserves the right to make changes in specifications and features shown without notice or obligation.

Materials and Finishes

Reference Information

Materials

Steel Quality

The meter equipment listed in this catalog is made of galvanized steel (AISI* G90) to afford the best possible weather proofing.

*American Iron and Steel Institute.

Steel Sheet

16-gauge, galvanized, sheet: 1 1/4 oz./ sq.ft. class zinc-coated. (AISI G90)

14-gauge, galvanized, sheet: 1 1/4 oz./ sq.ft. class zinc-coated.

Aluminum Extrusion

Wire-Terminals: Alloy; 6061-T6, Tin-plated for Cu/Al wire.

Bus Bar: Alloy; 6101-o & 6063-O

Aluminum Sheet

3000 series aluminum sheet, H14, or 5052 series aluminum sheet, H32. Where applicable thicknesses range from .064 – .125

Copper Sheet & Bus

Electrolytic copper with tin plating in most applications.

Insulating Materials

- In most units, support bases for current-carrying components are molded from fiberglass reinforced high-strength, track resistant, thermoset polyester molding compounds.
- Clear or black safety shields and polarity barriers are molded from high-strength, track resistant, polycarbonate molding compounds.
- Various sheet insulating materials, as appropriate for the application are utilized in the fabrication of flat, formed and punched component parts and barriers.

Finish

Process

Light gray state-of-the-art electrostatically applied powder paint offers a durable, non-fading finish. For further information concerning the chemical analysis of the weather-resistant finish, please contact the factory.

Metal Fasteners

Zinc-coated with a chromate dip.

Ratings & Compliance

Ratings & Compliance

All Milbank electrical enclosures in this catalog are rated NEMA 3R Enclosure unless otherwise specified on the product's page. All enclosures with a UL designation are constructed per the appropriate UL Standard and may be installed per the National Electric Code. UL procedure files associated with the UL Standards are listed as follows: Meter Sockets (UL 414, File E30202), Test Switches (UL 414, File E62531), Power Outlets (UL 231, File E90945), Panelboards (UL 67, File E32628) and Pullout Switches (UL 1429, File E133062). Additional standards are utilized as applicable: Meter Sockets (ANSI C12.7), Test Switches (ANSI C12.9) and Panelboards (NEMA PB-1).

Please consult serving utility for their requirements prior to ordering or installing, as specifications and approvals vary by utility, and may require local electrical inspector approval. All installations must be installed by a licensed electrician and must comply with all national and local codes, laws and regulations. Milbank reserves the right to make changes in specifications and features shown without notice or obligation.



Catalog Number	Alliant Energyt	WE Energies	Wisconsin Public Service	Madison Gas and Electric	Page Number
L572-XL-KK	X	X	X	X	19
L573-XL-KK	X	X	X	X	19
L574-XL-KK	X	X	X	X	19
L575-XL-KK	X	X	X	X	19
L576-XL-KK	X	X	X	X	19
U6689-O-100-KK		X	X	X	35
U6689-O-100-KK-LP		X	X	X	35
U6689-O-200-KK		X	X	X	35
U6689-O-200-KK-LP		X	X	X	35
S9995-B-XL		X	X		42
S9996-B-XL		X	X		42
S9997-B-XL		X	X		42
SDRC		X	X	X	42
SDRCW		X	X	X	42
U1211-RXL		X	X	X	9
U1252-X-KK	X	X	X	X	22
U1252-X-KK-K1-PED		X	X	X	22
U1253-X-KK	X	X	X	X	22
U1253-X-KK-K3-PED		X	X	X	22
U1254-X-KK	X	X	X	X	22
U1254-X-KK-K3-PED		X	X	X	22
U1255-X-KK-K4-PED		X	X	X	22
U1256-X-KK-PED		X	X	X	22
U1748-O-5T9-WI	X				34
U1748-O-WI	X	X	X	X	34
U1773-XL-TG-KK	X	X	X	X	8
U1779-RRL-5T9-K3	OH only			X	11
U1779-RRL-K3	X				11
U1783-O-KK	X	X	X	X	31
U2120-X-K7	X				14
U2594-X-K7	X				14
U2692-XL-KK		X	X	X	21
U2733-XT-PED-K7		X	X	Call for approval	25
U2732-XT-PED		X	X	Call for approval	25
U2732-XT-PED-K7		X	X	Call for approval	25
U2733-XT-PED		X	X	Call for approval	25
U2734-XT-PED		X	X	Call for approval	25
U2734-XT-PED-K7		X	X	Call for approval	25
U2735-XT-PED		X	X	Call for approval	25
U2735-XT-PED-K7		X	X	Call for approval	25
U2736-XT-PED		X	X	Call for approval	25
U2736-XT-PED-K7		X	X	Call for approval	25
U2872-XT		X	X	Call for approval	24
U2872-XT-5T9-K3	X			Call for approval	24
U2872-XT-K3	X			Call for approval	24
U2873-XT		X	X	Call for approval	24
U2873-XT-K3	X			Call for approval	24
U2874-XT		X	X	Call for approval	24
U2874-XT-K3	X			Call for approval	24
U3000-O-5T9-K3L-K2L	X				11



Please consult serving utility for their requirements prior to ordering or installing, as specifications and approvals vary by utility, and may require local electrical inspector approval. All installations must be installed by a licensed electrician and must comply with all national and local codes, laws and regulations. Milbank reserves the right to make changes in specifications and features shown without notice or obligation.

Utility Approvals Chart

Catalog Number	Alliant Energy	WE Energies	Wisconsin Public Service	Madison Gas and Electric	Page Number
U3000-O-K3L	X				11
U3000-O-K3L-K2L	X				11
U3358-O-KK	X	X	X	X	31
U3849-O-2/150	X	X			40
U3849-O-2/200		X	X	X	40
U3849-O-200-100	X	X			40
U3850-O-TG-KK	X				8
U4322-O-5T9	Call for approval			Call for approval	38
U4323-O-5T9				Call for approval	38
U4329-O		X	X	X	41
U4363-X-QG		X	X	OH approved only	11
U4664-X-8502			X		43
U4664-X-8507			X		43
U4664-X-9507			X		43
U4667-X-8013			X		44
U4667-X-8512			X		44
U4667-X-9504			X		44
U4667-X-9506			X		44
U4701-XL		X	X		13
U4724-O	X				32
U4724-O-5T9	X			X	32
U4801-XL	X				9
U4801-XL-5T9	X				9
U5136-O-100S	X	X	X	X	36
U5136-O-150S	X	X	X	X	36
U5136-O-200S	X	X	X	X	36
U5137-O-100S	X	X	X	X	36
U5137-O-150S	X	X	X	X	36
U5137-O-200S	X	X	X	X	36
U5168-XTL-100-KK	X	X	X	X	16
U5168-XTL-200-KK	X	X	X	X	16
U5701-O-100S	X				39
U5701-O-150S	X				39
U5701-O-200S	X				39
U5706-O-100S-KK	X				37
U5706-O-200S-KK	X				37
U5767-O-200-CB				X	17
U5767-X-200-CB				X	17
U5767-X-200-TF				X	17
U5787-O-200-TF				X	17
U5842-RL-100-KK		X	X	X	15
U5842-RL-200-KK		X	X	X	15
U5844-PXL-200-KK				Call for approval	15
U5882-X-KK-K1	X	X			27
U5882-X-KK-K1-PED		X	X	X	27
U5883-X-KK-K1	X	X			27
U5883-X-KK-K1-PED		X	X	X	27
U5884-X-KK-K1	X	X			27
U5884-X-KK-K1-PED		X	X	X	27

Please consult serving utility for their requirements prior to ordering or installing, as specifications and approvals vary by utility, and may require local electrical inspector approval. All installations must be installed by a licensed electrician and must comply with all national and local codes, laws and regulations. Milbank reserves the right to make changes in specifications and features shown without notice or obligation.



Catalog Number	Alliant Energyt	WE Energies	Wisconsin Public Service	Madison Gas and Electric	Page Number
U5885-X-KK-K1	X	X			27
U5885-X-KK-K1-PED		X	X	X	27
U5886-X-KK-K1	X	X			27
U5886-X-KK-K1-PED		X	X	X	27
U5902-X-KK-K1	X	X			27
U5902-X-KK-K1-PED		X	X	X	27
U5903-X-KK-K1	X	X			27
U5903-X-KK-K1-PED		X	X	X	27
U5904-X-KK-K1	X	X			27
U5904-X-KK-K1-PED		X	X	X	27
U5905-X-KK-K1	X	X			27
U5905-X-KK-K1-PED		X	X	X	27
U5906-X-KK-K1	X	X			27
U5906-X-KK-K1-PED		X	X	X	27
U5925-O-100-KK	X				37
U5925-O-150-KK	X				37
U5925-O-200-KK	X				37
U7362-RL-KK	X	X	X	X	20
U7363-RL-KK	X	X	X	X	20
U7364-RL-KK	X	X	X	X	20
U7365-RL-KK	X	X	X	X	20
U7366-RL-KK	X	X	X	X	20
U7375-RL-KK	X	X			15
U7421-RL		X	X		13
U7423-XL		X	X		13
U7487-RL-TG-KK	X	X	X		7
U7573-RL		X	X		12
U8032-XL-KK	X	X	X	X	18
U8033-XL-KK	X	X	X	X	18
U8034-XL-KK	X	X	X	X	18
U8035-XL-KK	X	X	X	X	18
U8036-XL-KK	X	X	X	X	18
U8624-RXL		X	X		10
U9107-O-CECHA			X	X	33
U9107-O-WI	X	X			33
U9108-O-WI	X	X	X		33
U9320-RXL		X	X		12
U9550-RL		X	X	X	10
U9551-O		X	X	X	10
U9700-RRL	X	X	X		13
U9701-RXL	X	X	X	X	13
UC2427-XL		X	X		30
UC2428-XL		X	X		30
UC3887-XL		X	X	X	29
UC3889-XL		X	X	X	29
UC7448-XL	X	X	X	X	29
UC7449-XL	X		X	X	29
UC7532-XL		X	X	X	29
WS		X	X	X	42



Please consult serving utility for their requirements prior to ordering or installing, as specifications and approvals vary by utility, and may require local electrical inspector approval. All installations must be installed by a licensed electrician and must comply with all national and local codes, laws and regulations. Milbank reserves the right to make changes in specifications and features shown without notice or obligation.

Please consult serving utility for their requirements prior to ordering or installing, as specifications and approvals vary by utility, and may require local electrical inspector approval. All installations must be installed by a licensed electrician and must comply with all national and local codes, laws and regulations. Milbank reserves the right to make changes in specifications and features shown without notice or obligation.



5T8K2	61	K4977-INT	61	Q250	58
6003	60	K5022	61	Q250H	58
6116	60	K5022-INT	61	Q260	58
A					
A7514	59	K5815	60	Q260H	58
A7515	59	K5820	60	Q270	58
A7516	59	K5830	60	Q270H	58
A7517	59	L			
A7518	59	L572-XL-KK	19	Q280	58
A7551	59	L573-XL-KK	19	Q280H	58
A8110	59	L574-XL-KK*	19	Q290	58
A8111	59	L575-XL-KK*	19	Q290H	58
A8112	59	L576-XL-KK*	19	Q2100	58
A9064	59	M			
A-GP	60	M5-144	60	Q2100H	58
B					
BL7474	61	Q			
BL7499	61	Q115	58	Q2125	58
C					
CP-21	60	Q115H	58	Q2125H	58
K					
K5T	61	Q120	58	QN2150	58
K1190	61	Q120H	58	QN2150H	58
K1350	60	Q125	58	QN2150R	58
K1350L	60	Q125H	58	QN2150RH	58
K1539	60	Q130	58	QN2200	58
K1540	60	Q130H	58	QN2200H	58
K1540L	60	Q135	58	QN2200R	58
K1541	60	Q135H	58	QN2200RH	58
K3082	60	Q140	58	S	
K3083	60	Q140H	58	S2291-TO	60
K3235	60	Q150	58	S8324	59
K3441	60	Q150H	58	S9995-B-XL	43
K3442	60	Q160	58	S9996-B-XL	43
K3865	61	Q160H	58	S9997-B-XL	43
K3866	61	Q170	58	U	
K4527	61	Q170H	58	U1211-RXL	9
K4528	61	Q215	58	U1252-X-KK	22
K4529	61	Q215H	58	U1252-X-KK-K1-PED	22
K4530	61	Q220	58	U1253-X-KK	22
K4687	46	Q220H	58	U1253-X-KK-K3-PED	22
K4688	46	Q225	58	U1254-X-KK	22
K4802	60	Q225H	58	U1254-X-KK-K3-PED	22
K4977-EXT	61	Q230	58	U1255-X-KK-K4-PED	22
		Q230H	58	U1256-X-KK-PED	22
		Q235	58	U1748-O-5T9-WI	34
		Q235H	58	U1748-O-WI	34
		Q240	58	U1773-XL-TG-KK	8
		Q240H	58	U1779-RRL-5T9-K3*	13
				U1779-RRL-K3*	13
				U1783-O-KK	31
				U2120-X-K7	14
				U2594-X-K7	14



Please consult serving utility for their requirements prior to ordering or installing, as specifications and approvals vary by utility, and may require local electrical inspector approval. All installations must be installed by a licensed electrician and must comply with all national and local codes, laws and regulations. Milbank reserves the right to make changes in specifications and features shown without notice or obligation.

U2692-XL-KK.....	21	U4801-XL-5T9.....	9	U7363-RL-KK.....	20
U2732-XT-PED.....	25	U4881-O.....	6	U7364-RL-KK.....	20
U2732-XT-PED-K7.....	25	U4881-O-50GB.....	6	U7365-RL-KK.....	20
U2733-XT-PED.....	25	U4881-O-60GB.....	6	U7366-RL-KK.....	20
U2733-XT-PED-K7.....	25	U5136-O-100S.....	36	U7375-RL-KK.....	15
U2734-XT-PED.....	25	U5136-O-150S.....	36	U7421-RL.....	12
U2734-XT-PED-K7.....	25	U5136-O-200S.....	36	U7423-XL.....	12
U2735-XT-PED.....	25	U5137-O-100S.....	36	U7487-RL-TG-KK.....	7
U2735-XT-PED-K7.....	25	U5137-O-150S.....	36	U7573-RL.....	11
U2736-XT-PED.....	25	U5137-O-200S.....	36	U8032-XL-KK.....	18
U2736-XT-PED-K7.....	25	U5168-XTL-100-KK.....	16	U8033-XL-KK.....	18
U2872-XT.....	24	U5168-XTL-200-KK.....	16	U8034-XL-KK.....	18
U2872-XT-5T9-K3.....	24	U5268-XTL-100-KK.....	16	U8035-XL-KK.....	18
U2872-XT-K3.....	24	U5268-XTL-200-KK.....	16	U8036-XL-KK.....	18
U2873-XT.....	24	U5701-O-100S.....	39	U8624-RXL.....	10
U2873-XT-K3.....	24	U5701-O-150S.....	39	U9107-O-CECHA.....	33
U2874-XT.....	24	U5701-O-200S.....	39	U9107-O-WI.....	33
U2874-XT-K3.....	24	U5706-O-100S-KK.....	37	U9108-O-WI.....	33
U3000-O-5T9-K3L-K2L*.....	13	U5706-O-200S-KK.....	37	U9320-RXL.....	11
U3000-O-K3L.....	13	U5767-O-200-CB.....	17	U9550-RL.....	10
U3000-O-K3L-K2L*.....	13	U5767-X-200-CB.....	17	U9551-O.....	10
U3358-O-KK*.....	31	U5767-X-200-TF.....	17	U9700-RRL.....	12
U3802.....	4	U5787-O-200-TF.....	17	U9701-RXL.....	12
U3812.....	4	U5842-RL-100-KK*.....	15	UC1290-RL*.....	29
U3822-20GWR.....	5	U5842-RL-200-KK*.....	15	UC1299-RL*.....	29
U3832.....	4	U5844-PXL-200-KK*.....	15	UC2427-XL.....	30
U3849-O-2/150.....	40	U5882-X-KK-K1-PED.....	27	UC2428-XL.....	30
U3849-O-2/200.....	40	U5883-X-KK-K1-PED.....	27	UC3887-XL.....	29
U3849-O-200-100.....	40	U5884-X-KK-K1-PED.....	27	UC3889-XL.....	29
U3850-O-TG-KK.....	8	U5885-X-KK-K1-PED.....	27	UC7448-XL.....	29
U3862.....	4	U5886-X-KK-K1-PED.....	27	UC7449-XL.....	29
U4322-O-5T9.....	38	U5902-X-KK-K1-PED.....	27	UC7532-XL.....	29
U4323-O-5T9.....	38	U5903-X-KK-K1-PED.....	27	UQFB-100.....	57
U4329-O.....	42	U5904-X-KK-K1-PED.....	27	UQFB-100-X1.....	57
U4363-X-QG.....	13	U5905-X-KK-K1-PED.....	27	UQFB-125.....	57
U4664.....	46	U5906-X-KK-K1-PED.....	27	UQFB-125-X1.....	57
U4664-X-8502.....	44	U5925-O-100-KK.....	37	UQFB-150.....	57
U4664-X-8507.....	44	U5925-O-150-KK.....	37	UQFB-150-X1.....	57
U4664-XT-9507.....	44	U5925-O-200-KK.....	37	UQFB-175.....	57
U4667.....	46	U6221-O-100-10GR*.....	39	UQFB-175-X1.....	57
U4667-X-8013.....	45	U6221-O-200-10GR*.....	39	UQFB-200.....	57
U4667-X-8512.....	45	U6317-O-2/150-K3L.....	40	UQFB-200-X1.....	57
U4667-XT-9504.....	45	U6317-O-100-200-K3L.....	40	UQFBH-100.....	57
U4667-XT-9506.....	45	U6689-O-100-KK.....	35	UQFBH-125.....	57
U4701-XL.....	12	U6689-O-100-KK-LP*.....	35	UQFBH-150.....	57
U4724-O.....	32	U6689-O-200-KK.....	35	UQFBH-175.....	57
U4724-O-5T9.....	32	U6689-O-200-KK-LP*.....	35	UQFBH-200.....	57
U4801-XL.....	9	U7362-RL-KK.....	20	UQFBH-M-100.....	57

Please consult serving utility for their requirements prior to ordering or installing, as specifications and approvals vary by utility, and may require local electrical inspector approval. All installations must be installed by a licensed electrician and must comply with all national and local codes, laws and regulations. Milbank reserves the right to make changes in specifications and features shown without notice or obligation.



UQFBH-M-125 57
 UQFBH-M-150 57
 UQFBH-M-175 57
 UQFBH-M-200 57
 UQFP-100 57
 UQFP-125 57
 UQFP-150 57
 UQFP-175..... 57
 UQFP-200..... 57
 UQFPH-100 57
 UQFPH-125..... 57
 UQFPH-150..... 57
 UQFPH-175 57
 UQFPH-200 57
 UQFPH-M-100..... 57
 UQFPH-M-125 57
 UQFPH-M-150 57
 UQFPH-M-175 57
 UQFPH-M-200..... 57
 UQFP-M-100..... 57
 UQFP-M-125 57
 UQFP-M-150..... 57
 UQFP-M-175 57
 UQFP-M-200 57

Z

Z703916-AC..... 47
 Z703917-AC46, 47
 Z703918-AC.....46, 47
 Z703919-AC.....46, 47
 Z703921-AC..... 47
 Z704693-AC46, 47
 Z704694-AC46, 47
 Z705420-AC46, 47
 Z705456-AC46, 47
 Z708145-AC..... 47
 Z802965-AC61
 Z814898-AC.....61
 Z901925-AC.....61
 Z903274-AO61
 Z904486-AO.....61
 Z916264-AO61
 Z916265-AO61



Please consult serving utility for their requirements prior to ordering or installing, as specifications and approvals vary by utility, and may require local electrical inspector approval. All installations must be installed by a licensed electrician and must comply with all national and local codes, laws and regulations. Milbank reserves the right to make changes in specifications and features shown without notice or obligation.



MILBANK[®]
ENERGY AT WORK

Milbank Manufacturing | 4801 Deramus Ave., Kansas City, MO 64120 | 877.483.5314
milbankworks.com | @milbankworks