

MILBANK[®]
ENERGY AT WORK



Ohio

Meter Mounting Equipment



Milbank Overview

Energy At Work since 1927

Milbank designs and manufactures electrical solutions that move and manage power for the residential, commercial, industrial, utility and transportation sectors. With more than 90 years of expertise in electrical engineering design and manufacturing, Milbank's portfolio includes metering equipment, enclosures and enclosed controls. Founded in 1927, Milbank is a family-owned, American manufacturer headquartered in Kansas City, Mo. For more information, please visit milbankworks.com.

METERING



As a market leader in electrical metering equipment, Milbank has set the standard for quality since 1927. Hundreds of configurations are available, including many sizes, knockout configurations, terminal configurations, bypass options, hubs, locks and connectors. Milbank has the socket you need with thousands of active products to meet your utility's requirements.

ENCLOSURES



Milbank's line of enclosures include commercial junction boxes, panel mount enclosures, transformer cabinets, wireway and troughs. Built with high-quality craftsmanship and materials which meet or exceed industry standards, Milbank enclosures are made to protect controls and equipment from dust, dirt and other harmful elements found in a wide variety of environments based on various NEMA ratings Milbank offers.

ENCLOSED CONTROLS



Milbank doesn't just build empty enclosures. We can deliver the entire package, complete with custom control equipment built to your exact specifications by our engineers. Milbank enclosed controls are an attractive, secure, easy-to-install and cost-effective solution when underground remote site power distribution and control equipment is required, replacing unsightly and inefficient strut and backboard structures.



Please consult serving utility for their requirements prior to ordering or installing, as specifications and approvals vary by utility, and may require local electrical inspector approval. All installations must be installed by a licensed electrician and must comply with all national and local codes, laws and regulations. Milbank reserves the right to make changes in specifications and features shown without notice or obligation.

Air Conditioner Disconnects

30-60 Amps AC disconnects	6
60 Amps AC disconnect with 20 Amps GFCI receptacle.....	7
Hot tub disconnects.....	8

Single Position Sockets

125-200 Amps, 4 terminals, ringless.....	9
200 Amps, 4, 5 & 7 terminals, lever bypass, ringless.....	10
320 Amps, 4 terminals, lever bypass, ringless	11
320 Amps, 7 terminals, lever, ringless	12

Unmetered Load Centers

100-200 Amps	13
--------------------	----

Meter Mains

125-200 Amps, 4 terminals, ringless.....	14
200 Amps, 4 & 7 terminals, lever bypass, ringless.....	15

Meter Mains with Load Center

100-200 Amps, 4 terminals, with load center, ringless	16
---	----

Meter Mains with Lever Bypass

320 Amps, 4 & 7 terminals, lever bypass, ringless.....	17-18
--	-------

Cold Sequence Meter Mains

200 & 400 Amps, 4, 5 & 7 terminals, ringless.....	19
---	----

Multi-Position Sockets

150 Amps, 4 terminals, ringless.....	20
200 Amps, 4 terminals, ringless.....	21-22
200 Amps, 5 terminals, lever bypass, ringless	23
200 Amps, 7 terminals, lever bypass, ringless	24

Multi-Position Meter Mains

200 Amps, 5 terminals, lever bypass, ringless	25
125-200 Amps, 4 terminals, ringless.....	26-29

Please consult serving utility for their requirements prior to ordering or installing, as specifications and approvals vary by utility, and may require local electrical inspector approval. All installations must be installed by a licensed electrician and must comply with all national and local codes, laws and regulations. Milbank reserves the right to make changes in specifications and features shown without notice or obligation.



Transformer Rated

20 Amps, plunger bypass, ringless	30
20 Amps, test switch provision	31
80 Amps, 6, 8 & 13 terminals, lever bypass	32
Test switches	33
Test switch worksheet	34
Current transformer cabinets.....	35

Pedestals

100-200 Amps, 4 terminals, meter main with load center, ringless	36
--	----

Temporary Power Units

125 Amps, 4 terminals, ringless	37
---------------------------------------	----

Surface & Pedestal Mount Power Outlets

125 Amps, 4 terminals, surface-mount	38
125 Amps, 4 terminals, pedestal-mount	39

Miscellaneous

Circuit breaker	40-41
Accessories	42-45
Enclosed controls.....	46-55
Commercial enclosures	56
Reference information	57-61
Utility Approval List	62
Index.....	63-64



Please consult serving utility for their requirements prior to ordering or installing, as specifications and approvals vary by utility, and may require local electrical inspector approval. All installations must be installed by a licensed electrician and must comply with all national and local codes, laws and regulations. Milbank reserves the right to make changes in specifications and features shown without notice or obligation.

Catalog Number Logic

How our product catalog numbers are derived

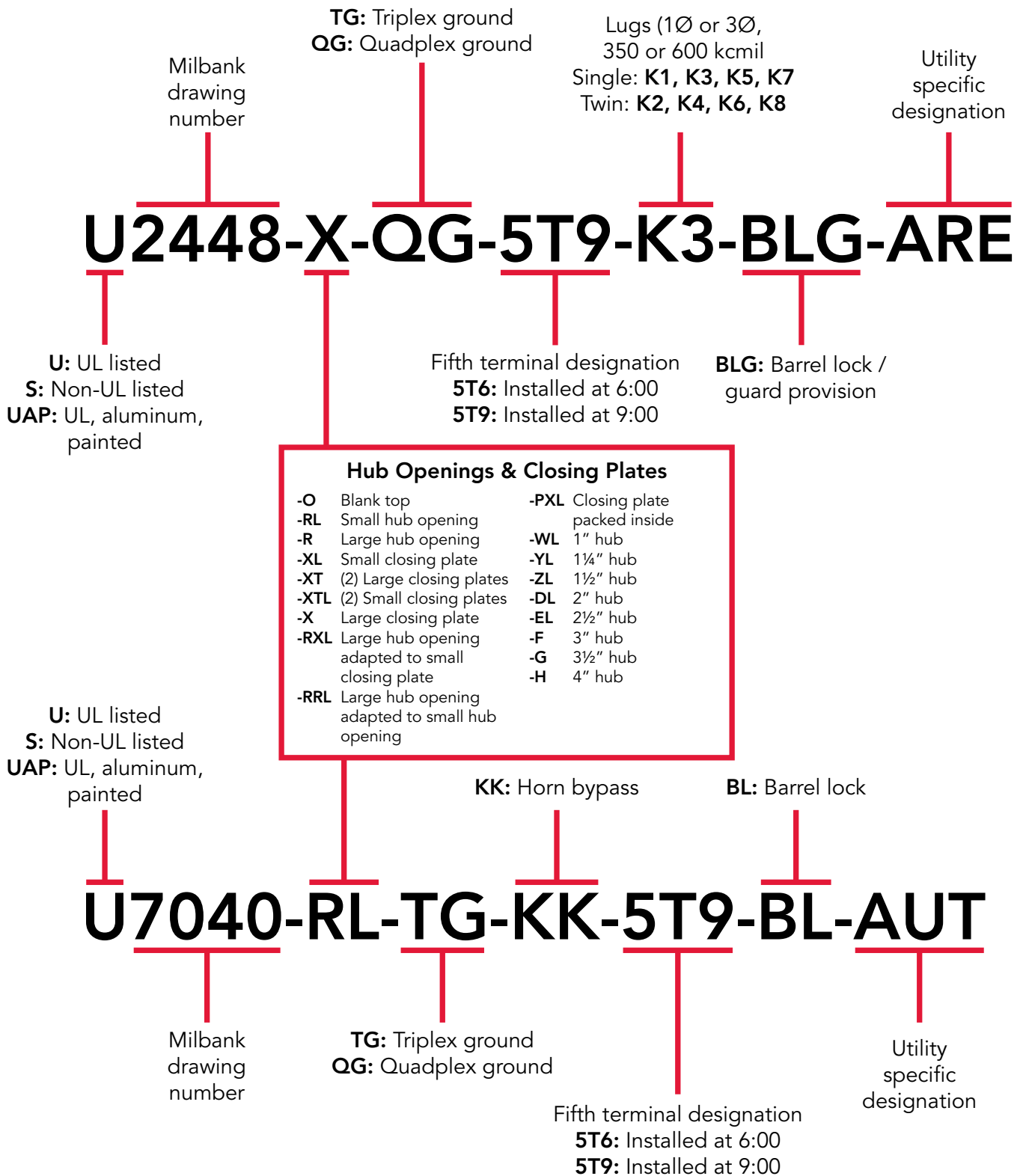

Please consult serving utility for their requirements prior to ordering or installing, as specifications and approvals vary by utility, and may require local electrical inspector approval. All installations must be installed by a licensed electrician and must comply with all national and local codes, laws and regulations. Milbank reserves the right to make changes in specifications and features shown without notice or obligation.



6

Air Conditioner Disconnects

30-60 Amps | Fusible & Non-Fusible



U3802



U3812



U3832

Milbank's air conditioner disconnect has a removable hinged cover that makes wiring a breeze. Our compact design meets all wire bending space requirements in the NEC and also complies with Article 440-14 in the NEC. To ensure the safest conditions, we designed our disconnect pullouts to be removable so they may be reinstalled in the OFF position. Another safety feature is the padlock provision on the front cover. As with all Milbank products, our enclosure is constructed of G90U galvanized steel and finished with an attractive, light gray, baked powder coating. Our state-of-the-art finish combines epoxy and polyester hybrid resins into a hybrid powder coating which is then electrostatically applied. This offers a durable, nonfading finish.

30-60 Amps | Air Conditioner Disconnects | 1Ø 240 VAC

Catalog Number	Amps	Type	Max H.P.	Weight (lbs.)	Line/Load Wire Range		Ground Wire Range CU/AL	Dimensions			Wire Rating	
					CU	AL		D"	W"	H"	CU °C	AL °C
U3802	60	Non-Fusible	10	3.25	#14-#2	#12-#2	#14-4	2½	5	7½	60°/75°	60°/75°
U3812	60	Non-Auto	10	3.25	#14-#2	#12-#2	#14-4	2½	5	7½	60°/75°	60°/75°
U3832	30	Fusible	3	2.5	#14-#3	#14-#3	#14-3	2½	5	7	60°/75°	60°/75°
U3862	60	Fusible	10	3.3	#14-#3	#14-#3	#14-3	2½	5	9	60°/75°	60°/75°

Notes

- UL listed as Enclosed Pullout Switch
- NEMA 3R
- Weather resistant
- 1-inch concentric knockouts



Please consult serving utility for their requirements prior to ordering or installing, as specifications and approvals vary by utility, and may require local electrical inspector approval. All installations must be installed by a licensed electrician and must comply with all national and local codes, laws and regulations. Milbank reserves the right to make changes in specifications and features shown without notice or obligation.

Air Conditioner Disconnects

7

60 Amps | With 20 Amps GFCI Receptacle



U3822-20GWR

Specifications

- Meets NEC #406.8 requirements
- Meets NEC #210.63 requirements
- UL listed as Power Outlet
- NEMA 3R
- In-use cover*
- Duplex ground connector
- 1-inch concentric knockouts
- 1Ø, 240 VAC
- 60 Amps, non-fused
- 20 Amps GFCI receptacle
- Reset/test button
- Weather and tamper resistant

60 Amps | Air Conditioner Disconnect with 20 Amps GFCI Receptacle | 1Ø, 240 VAC

Catalog Number	Type	Max H.P.	Weight (lbs.)	Line/Load Wire Range		Ground Wire Range CU/AL	Dimensions			Wire Rating	
				CU	AL		D"	W"	H"	CU °C	AL °C
U3822-20GWR	Non-Fusible	10	6	#14-#2	#12-#2	#14-4	4½	5¼	7½	60°/75°	60°/75°

Notes

- **Disconnect Pullouts:** To ensure the safest conditions, Milbank disconnect pullouts are reversible so they may be reinstalled in the OFF position.
 - **Padlock Provision:** All units are designed with a padlock provision on the cover for security.
- *Rated as an in-use cover (cover may be closed with cords plugged into receptacle).

Please consult serving utility for their requirements prior to ordering or installing, as specifications and approvals vary by utility, and may require local electrical inspector approval. All installations must be installed by a licensed electrician and must comply with all national and local codes, laws and regulations. Milbank reserves the right to make changes in specifications and features shown without notice or obligation.



Hot Tub Disconnects

NEMA 3R Enclosures



U4881-O-50GB



U4881-O-60GB

Specifications

- 240 VAC ground fault protection
- UL listed, NEMA 3R weather-resistant
- 2-pole, 50 or 60 Amps GFCI breaker protection
- Compact size
- Three or four wire installation
- 1Ø, 120/240 VAC
- Standard package of 12
- Two extra 1-pole breaker spaces
- 100 Amps overall rating
- Easy to install

100 Amps | Hot Tub Disconnect or Sub Panel Breaker Enclosure | NEMA 3R

Catalog Number	Breaker Amps	Type	Weight (lbs.)	Line/Load Wire Range		Ground Wire Range CU/AL	Dimensions		
				CU	AL		D"	W"	H"
U4881-O-50GB	50	Breaker	8	#14-1/0	#14-1/0	#14-1/0	3¾	7½	8½
U4881-O-60GB	60	Breaker	8	#14-1/0	#14-1/0	#14-1/0	3¾	7½	8½



Please consult serving utility for their requirements prior to ordering or installing, as specifications and approvals vary by utility, and may require local electrical inspector approval. All installations must be installed by a licensed electrician and must comply with all national and local codes, laws and regulations. Milbank reserves the right to make changes in specifications and features shown without notice or obligation.

Single Position Sockets

125-200 Amps | 4 Terminals | Ringless | 600 VAC



U7487-RL-TG-KK

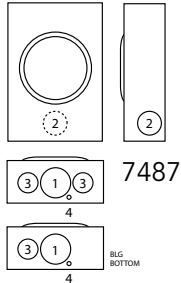

U7040-RL-TG-KK

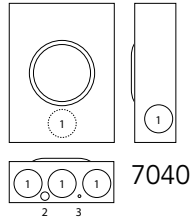

U4532-XL

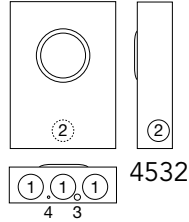

U1980-O-KK

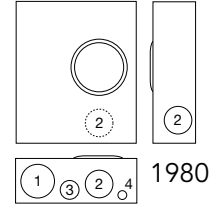

125-200 Amps | 4 Terminals | Single Position | Ringless | 1Ø3W

Catalog Number	Amps	Service	Hub	Connectors CU/AL		Bypass	Dimensions			Knockouts			
				Line	Load		D"	W"	H"	1	2	3	4
U7487-RL-TG-KK	125	OH/UG	H.O.	#6-2/0	#6-2/0	Horn	3 ⁵ / ₁₆	8	11 ¹ / ₂	2	1 ¹ / ₂	1 ¹ / ₄	1 ¹ / ₄
U7487-RL-TG-KK-BLG*	125	OH/UG	H.O.	#6-2/0	#6-2/0	Horn	3 ⁵ / ₁₆	8	11 ¹ / ₂	2	—	1 ¹ / ₄	1 ¹ / ₄
U7021-RL-TG-KK	200	OH	H.O.	#6-350	#6-350	Horn	4 ⁷ / ₈	8	15 ¹ / ₂	2 ¹ / ₂	1 ¹ / ₄ , 1 ¹ / ₂	1 ¹ / ₄	—
U7021-RL-TG-KK-BLG*	200	OH	H.O.	#6-350	#6-350	Horn	4 ⁷ / ₈	8	15 ¹ / ₂	2 ¹ / ₂	1 ¹ / ₄ , 1 ¹ / ₂	1 ¹ / ₄	—
U7040-RL-TG-KK	200	OH/UG	H.O.	#6-350	#6-350	Horn	4 ⁷ / ₈	11	14 ⁵ / ₈	2 ¹ / ₂	1 ¹ / ₄ , 1 ¹ / ₂	1 ¹ / ₄	—
U7040-RL-TG-KK-BLG*	200	OH/UG	H.O.	#6-350	#6-350	Horn	4 ⁷ / ₈	11	14 ⁵ / ₈	2 ¹ / ₂	1 ¹ / ₄ , 1 ¹ / ₂	1 ¹ / ₄	—
U7040-XL-TG-KK	200	OH/UG	C.P.	#6-350	#6-350	Horn	4 ⁷ / ₈	11	14 ⁵ / ₈	2 ¹ / ₂	1 ¹ / ₄ , 1 ¹ / ₂	1 ¹ / ₄	—
U4532-XL	200	OH/UG	C.P.	#6-350	(2) #6-350	None	4 ⁷ / ₈	15	20 ¹ / ₂	3	2 ¹ / ₂	1 ¹ / ₄ , 1 ¹ / ₂	1 ¹ / ₄

200 Amps | 4 Terminals | Single Position | Side Wireway | Ringless | 1Ø3W

Catalog Number	Service	Hub	Connectors CU/AL		Bypass	Dimensions			Knockouts			
			Line	Load		D"	W"	H"	1	2	3	4
U1980-O-KK	UG	Blank	#6-350	#6-350	Horn	4 ¹ / ₂	13	15 ¹ / ₄	3	2 ¹ / ₂	1 ¹ / ₂	1 ¹ / ₄ , 1 ¹ / ₂
U1980-O-KK-BLG*	UG	Blank	#6-350	#6-350	Horn	4 ¹ / ₂	13	15 ¹ / ₄	3 ¹ / ₂	2 ¹ / ₂	1 ¹ / ₂	1 ¹ / ₄ , 1 ¹ / ₂

Notes

- **Hubs:** Order hubs separately — see accessories page for ordering information.
- **Fifth Terminal:** For field-installable fifth terminal for **U7021**, **U7040**, **U4532** and **U1980**, order catalog number **K5T**. For the **U7487**, order catalog number **5T8K2**.
- **Connectors:** Extruded aluminum connectors are tin plated.
- **U4532:** Includes twin lug connector on load side.
- **Tap Connector:** For tap connector, order **K4977-INT**.

*Product numbers ending in **-BLG** are used in AEP service areas.

Please consult serving utility for their requirements prior to ordering or installing, as specifications and approvals vary by utility, and may require local electrical inspector approval. All installations must be installed by a licensed electrician and must comply with all national and local codes, laws and regulations. Milbank reserves the right to make changes in specifications and features shown without notice or obligation.



1 □

Single Position Lever Bypass

200 Amps | 4, 5 & 7 Terminals | Ringless | 600 VAC



U3278-RL



U9551-RRL



U9701-RRL

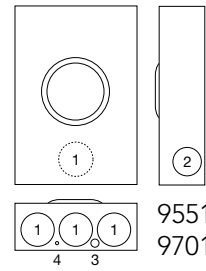
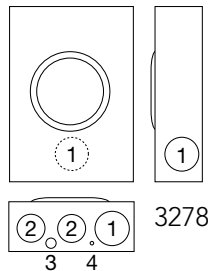

200 Amps | Single Position | Lever Bypass | Ringless

Catalog Number	Terminals	Service	Hub	Connectors CU/AL	Phase	Dimensions			Knockouts			
						D"	W"	H"	1	2	3	4
U3278-RL	4	OH	H.O.	#6-350	1Ø3W	4 ⁷ / ₈	11	15 ¹ / ₂	2 ¹ / ₂	2	1 ¹ / ₄ , 1 ¹ / ₂	1 ¹ / ₄

200 Amps | Single Position | Heavy Duty Lever Bypass | Ringless

Catalog Number	Terminals	Service	Hub	Connectors CU/AL	Phase	Dimensions			Knockouts			
						D"	W"	H"	1	2	3	4
U9551-RRL	5	OH/UG	H.O.	#6-350	1Ø3W or 3Ø3W	4 ⁷ / ₈	13	19	3	2 ¹ / ₂	1 ¹ / ₄ , 1 ¹ / ₂	1 ¹ / ₄
U9701-RRL	7	OH/UG	H.O.	#6-350	3Ø4W	4 ⁷ / ₈	13	19	3	2 ¹ / ₂	1 ¹ / ₄ , 1 ¹ / ₂	1 ¹ / ₄
U9701-RRL-BLG*	7	OH/UG	H.O.	#6-350	3Ø4W	4 ⁷ / ₈	13	19	3	2 ¹ / ₂	1 ¹ / ₄ , 1 ¹ / ₂	1 ¹ / ₄

Notes

- **Hubs:** For proper hub selection, see the hub suffix chart on the accessories page.
- **Connectors:** Extruded aluminum connectors are tin plated.
- **Bypass:** The lever on the **U3278** unit operates the bypass device only; it does not provide clamping action on the meter spades. The levers on the **U9551** and **U9701** units supply clamping action on meter spades and also operate the bypass devices.

*Product numbers ending in **-BLG** are used in AEP service areas.



Please consult serving utility for their requirements prior to ordering or installing, as specifications and approvals vary by utility, and may require local electrical inspector approval. All installations must be installed by a licensed electrician and must comply with all national and local codes, laws and regulations. Milbank reserves the right to make changes in specifications and features shown without notice or obligation.

Single Position Lever Bypass

320 Amps | 4 Terminals | Ringless | 600 VAC



U4363-X-QG-K3-K2

U1079-RRL-K3

U1129-O-K3L-K2L

U1797-O-K3L-K2L

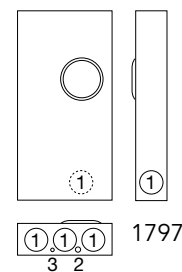
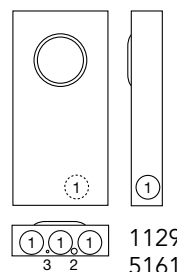
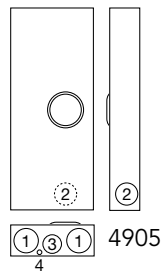
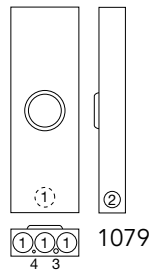
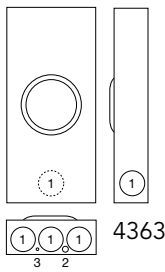

320 Amps | 4 Terminals | Single Position | Heavy Duty Lever Bypass | Ringless | 1Ø3W

Catalog Number	Service	Hub	Connectors CU/AL		Bypass	Dimensions			Knockouts			
			Line	Load		D"	W"	H"	1	2	3	4
U4363-X-QG-K3-K2	OH	C.P.	(1) #4-600 or (2) 1/0-250	(2)#6-350	Lever	4 ⁷ / ₈	13	28 ¹ / ₄	3	1/4, 1/2	1/4	—
U1079-RRL-K3	OH	H.O.	(1) #4-600 or (2) 1/0-250	3/8" x 16 Studs	Lever	4 ⁷ / ₈	13	38 ³ / ₄	3	2 ¹ / ₂	1/4, 1/2	1/4
U4905-X	OH/UG	C.P.	3/8" x 16 Studs	3/8" x 16 Studs	Lever	5 ³ / ₄	16	38 ³ / ₄	4	3 ¹ / ₂	3	1/4, 1/2
U4905-X-BLG	OH/UG	C.P.	3/8" x 16 Studs	3/8" x 16 Studs	Lever	5 ³ / ₄	16	38 ³ / ₄	4	3 ¹ / ₂	3	1/4, 1/2
U1129-O-K3L-K2L	UG	Blank	(1) #4-600 or (2) 1/0-250	(2) #6-350	Lever	4 ⁷ / ₈	15	30	3	1/4, 1/2	1/4	—
U5161-X-K3L-K2L-BLG*	OH/UG	C.P.	(1) #4-600 or (2) 1/0-250	(2) #6-350	Lever	4 ⁷ / ₈	15	30	3	1/2	1/4	—
U1797-O-K3L-K2L	UG	Blank	(1) #4-600 or (2) 1/0-250	(2) #6-350	Lever	4 ⁷ / ₈	15	30	3	1/4, 1/2	1/4	—
U1797-O-K3L-K2L-BLG*	UG	Blank	(1) #4-600 or (2) 1/0-250	(2) #6-350	Lever	4 ⁷ / ₈	15	30	3	1/4, 1/2	1/4	—

Notes

- **Side Wireway:** U1797 and U4905 are side wireway units.
- **Bypass:** Lever supplies clamping action and also operates bypass device.
- **Hubs:** For proper hub selection, see the hub suffix chart on the accessories page.
- **Connectors:** Supplied with 3/8" x 16 hex head nuts with Belleville washers. For connector kits, order as extra **K1540** (single 600 kcmil). For twin lug connectors, order as extra **K1350** (twin 350 kcmil). Order two kits to cover both line and load on **U4905** and one kit for load side of **U1079**.
- **Fifth Terminal:** For factory-installed fifth terminal in the 6 o'clock position, add the suffix **-5T6** to the catalog number. For factory-installed fifth terminal in the 9 o'clock position, add the suffix **-5T9** to the catalog number. For field-installable fifth terminal, order as extra catalog number **K3865** for **U1129**, **U1797** and **U4905** and **K3866** for **U1079**.

*Product number that end in **-BLG** are used in AEP service areas.

Please consult serving utility for their requirements prior to ordering or installing, as specifications and approvals vary by utility, and may require local electrical inspector approval. All installations must be installed by a licensed electrician and must comply with all national and local codes, laws and regulations. Milbank reserves the right to make changes in specifications and features shown without notice or obligation.



Single Position Lever Bypass

320 Amps | 7 Terminals | Ringless | 600 VAC



U2120-X-K7

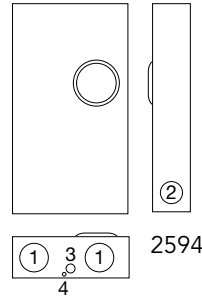
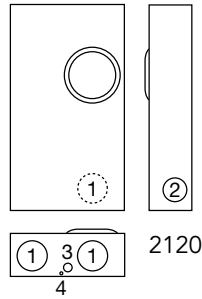

U2594-X

320 Amps | 7 Terminals | Single Position | Side Wireway | Ringless | 3Ø4W

Catalog Number	Service	Hub	Connectors CU/AL		Bypass	Dimensions			Knockouts			
			Line	Load		D"	W"	H"	1	2	3	4
U2594-X	OH/UG	C.P.	3/8" x 16 Studs	3/8" x 16 Studs	Lever	6 1/2	19	34 1/8	4	3	1	1/4
U2594-X-K7-K6-BLG*	OH/UG	C.P.	3/8" x 16 Studs	3/8" x 16 Studs	Lever	6 1/2	19	34 1/8	4	3	1	1/4
U2594-X-BLG*	OH/UG	C.P.	3/8" x 16 Studs	3/8" x 16 Studs	Lever	6 1/2	19	34 1/8	4	3	1	1/4
U2120-X-K7	UG	C.P.	(1) #4-600 or (2) 1/0-250	3/8" x 16 Studs	Lever	6 1/2	17 3/4	31 3/4	4	3	1	1/4

Notes

- **Hubs:** For proper hub selection, see the hub suffix chart on the accessories page.
- **Bypass:** Lever supplies clamping action and also operates bypass device.
- **Connectors:** Supplied with 3/8" x 16 hex head nuts with Belleville washers. For connector kits, order as extra **K3441** (single 600 kcmil). For twin lug connectors, order as extra **K3442** (twin 350 kcmil). Separate kits are required for both line and load. Line side connectors furnished on **U2120**.

*Product number that end in **-BLG** are used in AEP service areas.



Please consult serving utility for their requirements prior to ordering or installing, as specifications and approvals vary by utility, and may require local electrical inspector approval. All installations must be installed by a licensed electrician and must comply with all national and local codes, laws and regulations. Milbank reserves the right to make changes in specifications and features shown without notice or obligation.

Unmetered Load Centers

200 Amps | 120/240 VAC



USE-22-200-MB

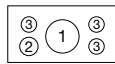
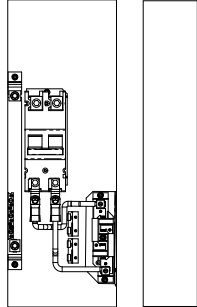

USE-22



U5971-XL-200

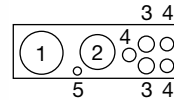
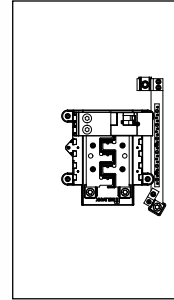

5971

200 Amps | Unmetered Load Center with Main Breaker

Catalog Number	Main Breaker Amps	Circuits	Service	Hub	Dimensions			Knockouts				
					D"	W"	H"	1	2	3	4	5
USE-22-200-MB	200	4	OH	2 in.	4	8	23	2	1	1/2, 3/4	—	—
U5971-XL-100	100	10	OH/UG	C.P.	4 1/2	14 1/8	25 1/6	3	2	1	1/2, 3/4	1/4, 1/2
U5971-XL-150	150	8	OH/UG	C.P.	4 1/2	14 1/8	25 1/6	3	2	1	1/2, 3/4	1/4, 1/2
U5971-XL-200	200	8	OH/UG	C.P.	4 1/2	14 1/8	25 1/6	3	2	1	1/2, 3/4	1/4, 1/2

Notes

- **AIC Rating:** This units are rated 22K AIC.
- **Breaker Interlock:** U5971 accepts breaker interlock kits — order **K5815** for large QN with small frame Q, **K5820** for large frame QN with large frame QN or **K5830** for small frame Q to small frame Q.

Please consult serving utility for their requirements prior to ordering or installing, as specifications and approvals vary by utility, and may require local electrical inspector approval. All installations must be installed by a licensed electrician and must comply with all national and local codes, laws and regulations. Milbank reserves the right to make changes in specifications and features shown without notice or obligation.



125-200 Amps | 4 Terminals | Ringless | 120/240 VAC



U3989-XL

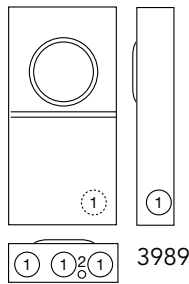

3989



U3491-XL-200

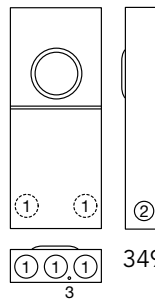

3491



U5844-PXL-200-KK

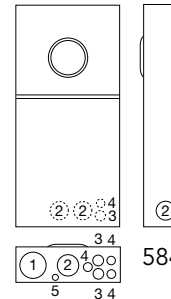

5844

125-200 Amps | 4 Terminals | Meter Mains | Ringless | 1Ø3W

Catalog Number	Amps	Service	Hub	Connectors CU/AL		Bypass	Dimensions			Knockouts				
				Line	Load		D"	W"	H"	1	2	3	4	5
U3989-XL	125	OH/UG	C.P.	#6-2/0	CB	None	3 ³ / ₄	11	22	2	1/4, 1/2	—	—	—
U5844-PXL-200-KK	200	OH/UG	C.P.	#6-350	CB	Horn	4 1/2	14	30	3	2 1/2	1	1/2, 3/4	1/4, 1/2
U5844-PXL-200-KK-BLG*	200	OH/UG	C.P.	#6-350	CB	Horn	4 1/2	14	30	3	2 1/2	1	1/2, 3/4	1/4, 1/2

Notes

- **Hubs:** For proper hub selection, see the hub suffix chart on the accessories page.
 - **Breaker:** For replacement breakers for **U3491**, order **UQFB-200-X1**; for **U5844** order **QN2200H**. For **U3989**, order approved small frame breakers 125 Amps or less per the rating label.
 - **Fifth Terminal:** For field-installable fifth terminal kit, order **K5T**.
 - **AIC Rating:** The **U5844** is 22K AIC rated.
 - **Closing Plate:** Product numbers with **PXL-** come with closing plate packed inside of carton.
- *Product numbers ending in **-BLG** are used in AEP service areas.



Please consult serving utility for their requirements prior to ordering or installing, as specifications and approvals vary by utility, and may require local electrical inspector approval. All installations must be installed by a licensed electrician and must comply with all national and local codes, laws and regulations. Milbank reserves the right to make changes in specifications and features shown without notice or obligation.

Meter Mains

200 Amps | 4 & 7 Terminals | Lever Bypass | Ringless

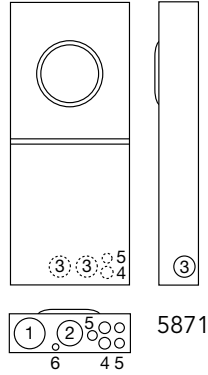

U5871-XL-200

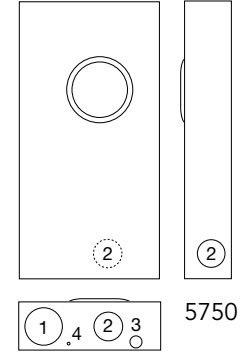

U5750-RXL-200-BL

200 Amps | Meter Mains | Lever Bypass | Ringless

Catalog Number	Breaker Amps	Terminals	Service	Hub	Connectors CU/AL - Line	Dimensions			Knockouts					
						D"	W"	H"	1	2	3	4	5	6
U5871-XL-200	200	4	OH/UG	C.P.	#6-350	4½	14⅞	32	3	2½	2	1	½,¾	¼,½
U5750-RXL-200-BL	200	7	OH/UG	C.P.	#6-350	5¾	17¾	34	4	3	1	¼	—	—

Notes

- **Breakers:** U5871 is rated 22K AIC with QNR2200H main installed. U5750 is rated 10K AIC with UQFB-3200 main installed.
- **-BL:** Barrel lock
- **Fifth Terminal:** For field-installable fifth terminal for U5871, order K3865.
- **Interlock Kit:** For generator auxiliary circuit breaker interlock for U5871, order K5815 for large QN with small frame Q; order K5820 for large frame QN with large frame QN.

Generator Interlock — for use with U5168 and U5268

	K5815 Large QN with small frame Q	K5820 Large frame QN with large frame QN	K5830 Small frame Q to small frame Q
---	---	--	--

Please consult serving utility for their requirements prior to ordering or installing, as specifications and approvals vary by utility, and may require local electrical inspector approval. All installations must be installed by a licensed electrician and must comply with all national and local codes, laws and regulations. Milbank reserves the right to make changes in specifications and features shown without notice or obligation.



16

Meter Mains with Load Center

200 Amps | 4 Terminals | Ringless | 120/240 VAC



U5168-XTL-200-KK

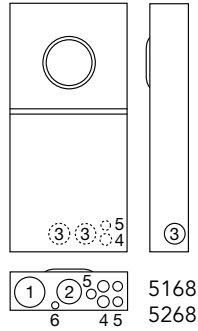

U5268-XTL-200-KK

Knockouts					
1	2	3	4	5	6
3	2½	2	1	½, ¾	¼, ½

200 Amps | 4 Terminals | Meter Mains | Horn Bypass | Ringless | 1Ø3W

Catalog Number	Breaker Amps	Circuits	Service	Hub	Connectors CU/AL - Line	Dimensions		
						D"	W"	H"
U5168-XTL-100-KK	100	10	OH/UG	C.P.	#6-350	4½	14⅝	32
U5168-XTL-100-KK-BLG*	100	10	OH/UG	C.P.	#6-350	4½	14⅝	32
U5168-XTL-150-KK	150	8	OH/UG	C.P.	#6-350	4½	14⅝	32
U5168-XTL-150-KK-BLG*	150	8	OH/UG	C.P.	#6-350	4½	14⅝	32
U5168-XTL-200-KK	200	8	OH/UG	C.P.	#6-350	4½	14⅝	32
U5168-XTL-200-KK-BLG*	200	8	OH/UG	C.P.	#6-350	4½	14⅝	32
U5268-XTL-150-KK	150	20	OH/UG	C.P.	#6-350	4½	14⅝	32
U5268-XTL-200-KK	200	20	OH/UG	C.P.	#6-350	4½	14⅝	32
U5268-XTL-200-KK-BLG*	200	20	OH/UG	C.P.	#6-350	4½	14⅝	32

Notes

- **Fifth Terminal:** For field-installable fifth terminal, order **K5T**.
 - **Breakers:** Rated 22K AIC with **QN2200H** main installed for **U5168** and **U5268**.
 - **Sub Feed Lugs:** #6-350 sub feed lugs provided on 8 circuit interior. **Not available on 20 circuit interior.**
 - **Main Lug Kit:** Main lug feed-through kit **K3701** available.
 - **XTL-:** Two small hub closing plates.
 - **Interlock Kit:** For generator auxiliary circuit breaker interlock for **U5871**, order **K5815** for large QN with small frame Q; order **K5820** for large frame QN with large frame QN.
- *Product numbers with **-BLG** are used in AEP service areas.

Branch Breaker Chart

AIC Rating	Amps	Siemens	Cutler-Hammer	GE	Square D
10K	150-200	QNR	BR (150A only)	—	—
	≤ 125	QP	HQP, BR	THQL, THQL-GF	Homeline
22K	150-200	QNRH	—	—	—
	≤ 125	QPH	—	—	—



Please consult serving utility for their requirements prior to ordering or installing, as specifications and approvals vary by utility, and may require local electrical inspector approval. All installations must be installed by a licensed electrician and must comply with all national and local codes, laws and regulations. Milbank reserves the right to make changes in specifications and features shown without notice or obligation.

Lever Bypass Meter Mains

320 Amps | 4 Terminals | Ringless | 120/240 VAC



U5059-X-2/200



U5890-X-2/200-BL
(shown with lugs installed)



U5891-X-2/200-MLK-BL

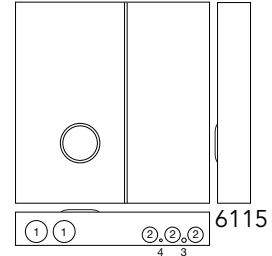
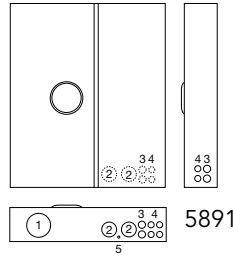
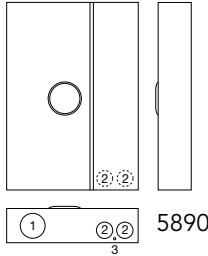
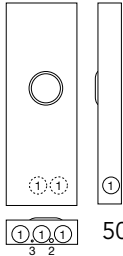

320 Amps | 4 & 7 Terminals | Meter Mains | Lever Bypass | OH/UG | Ringless

Catalog Number	Breaker Amps	Terminals	Hub	Connectors CU/AL - Line	Branch Circuits	Dimensions			Knockouts				
						D"	W"	H"	1	2	3	4	5
U5059-X-K3L	Provision	4	C.P.	(1) #4-600 or (2) 1/0-250	N/A	4 ⁷ / ₈	15	42	3	1/4, 1/2	1/4	—	—
U5059-X-2/200-K3L	200	4	C.P.	(1) #4-600 or (2) 1/0-250	N/A	4 ⁷ / ₈	15	42	3	1/4, 1/2	1/4	—	—
U5890-X-2/200-BL	200	4	C.P.	3/8" x 16 Studs	N/A	6	24 ¹ / ₂	35	4	2 ¹ / ₂	1/4	—	—
U5890-X-2/200-BLG*	200	4	C.P.	3/8" x 16 Studs	N/A	6	24 ¹ / ₂	35	4	2 ¹ / ₂	1/4	—	—
U5891-X-2/200-MLK-BL	200	4	C.P.	3/8" x 16 Studs	12	6	29 ¹ / ₂	35	4	2 ¹ / ₂	1	1/2, 3/4	1/4
U6115-X-2/200-K7L†	200	7	C.P.	#4-600 kcmil or (2) 1/0-250	N/A	7	34 ¹ / ₄	34	4	2 ¹ / ₂	1/2	1/4	—

Notes

- **AIC Rating:** 22K AIC standard.
- **Breakers:** For **U5059** main breakers, order **UQFPH-100, -150** or **-200**.
- **-MLK:** Main lug feed-through kit **K3701** factory installed.
- **Fifth Terminal:** For field-installable fifth terminal, order catalog number **K3865**.
- **Connectors:** Supplied with 3/8" x 16 hex head nuts with Belleville washers. For connector kits, order as extra **K1540** (single 600 kcmil). For twin lug connectors, order as extra **K1350** (twin 350 kcmil). The extra stud on line side is a wire stop.
- **-BL:** Barrel lock.

*Product numbers ending with **-BLG** are used in AEP service areas.

†7 Terminal three-phase four-wire.

Please consult serving utility for their requirements prior to ordering or installing, as specifications and approvals vary by utility, and may require local electrical inspector approval. All installations must be installed by a licensed electrician and must comply with all national and local codes, laws and regulations. Milbank reserves the right to make changes in specifications and features shown without notice or obligation.



1 8 Lever Bypass Meter Mains w/ 400 Amps Breaker

320 Amps | 4 & 7 Terminals | Ringless | Jaw Clamping

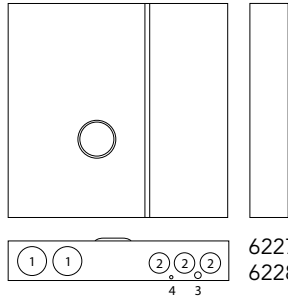

U6228-X-400-K3

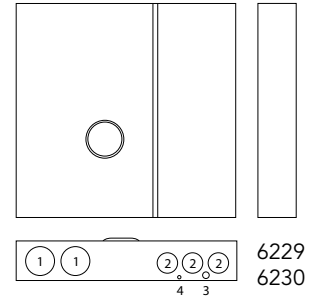

U6230-X-400-K7

320 Amps | 4 Terminals | Meter Mains | Lever Bypass | Ringless

Catalog Number	Service	Hub	Connectors CU/AL	Dimensions			Knockouts			
			Line	D"	W"	H"	1	2	3	4
U6227-X-400-K3	OH/UG	C.P.	600 kcmil	6	36¼	34	4	2½	½	¼
U6228-X-400-K3*	OH/UG	C.P.	600 kcmil	6	36¼	34	4	2½	½	¼

320 Amps | 7 Terminals | Meter Mains | Lever Bypass | Ringless

Catalog Number	Service	Hub	Connectors CU/AL	Dimensions			Knockouts			
			Line	D"	W"	H"	1	2	3	4
U6229-X-400-K7	OH/UG	C.P.	600 kcmil	6	36¼	34	4	2½	½	¼
U6230-X-400-K7*	OH/UG	C.P.	600 kcmil	6	36¼	34	4	2½	½	¼

Notes

- **Short Circuit Current Rating:** 22K AIC at 120/240 VAC or 10K at 480 VAC.
- *U6228 and U6230 have side bussing.



Please consult serving utility for their requirements prior to ordering or installing, as specifications and approvals vary by utility, and may require local electrical inspector approval. All installations must be installed by a licensed electrician and must comply with all national and local codes, laws and regulations. Milbank reserves the right to make changes in specifications and features shown without notice or obligation.

Cold Sequence Meter Mains

200-320 Amps | 4, 5 & 7 Terminals | Ringless



U5767-X-200-CB



U5787-O-200-CB

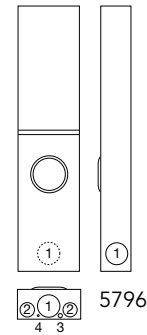

5796

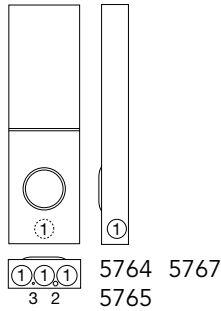

5764 5767
5765

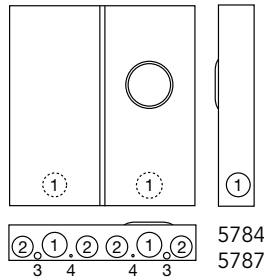

5784
5787

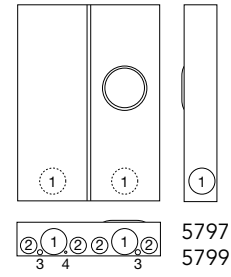

5797
5799

200 Amps | Circuit Breaker Disconnect ahead of Meter Socket | Lever Bypass

Catalog Number	Terminals	Service	Hub	Connectors CU/AL - Load	Phase	Dimensions			Knockouts			
						D"	W"	H"	1	2	3	4
U5764-X-200-CB	4	OH/UG	C.P.	#6-350	1Ø3W	4 ²⁷ / ₃₂	13	43	4	2½	¼	—
U5765-X-200-CB	5	OH/UG	C.P.	#6-350	1Ø3W or 3Ø3W	4 ²⁷ / ₃₂	13	43	4	2½	1	½, ¾
U5784-O-200-CB	5	UG	Blank	#6-350	1Ø3W or 3Ø3W	4 ²⁷ / ₃₂	26	28	4	2½	¼	—
U5767-X-200-CB	7	OH/UG	C.P.	#6-350	3Ø4W	4 ²⁷ / ₃₂	13	43	4	2½	1	½, ¾
U5787-O-200-CB	7	UG	Blank	#6-350	3Ø4W	6	26	28	4	2½	1	½, ¾

320 Amps (420 Amps Continuous) | Circuit Breaker Disconnect ahead of Meter Socket | Lever Bypass

Catalog Number	Terminals	Service	Hub	Connectors CU/AL - Load	Phase	Dimensions			Knockouts			
						D"	W"	H"	1	2	3	4
U5797-O-400-CB	5	UG	Blank	3/0-500	1Ø3W or 3Ø3W	6	26	36	4	2½	1	½, ¾
U5796-X-400-CB	7	OH/UG	C.P.	3/0-500	3Ø4W	6	13	56	4	2½	¼	—
U5799-O-400-CB	7	UG	Blank	3/0-500	3Ø4W	6	26	36	4	2½	1	½, ¾

Notes

- **Hubs:** For proper hub selection, refer to the hub suffix chart on the accessories page.

Please consult serving utility for their requirements prior to ordering or installing, as specifications and approvals vary by utility, and may require local electrical inspector approval. All installations must be installed by a licensed electrician and must comply with all national and local codes, laws and regulations. Milbank reserves the right to make changes in specifications and features shown without notice or obligation.



Multi-Position Sockets

150 Amps | 4 Terminals | Ringless | 300 VAC



U1232-RRL-KK-K1

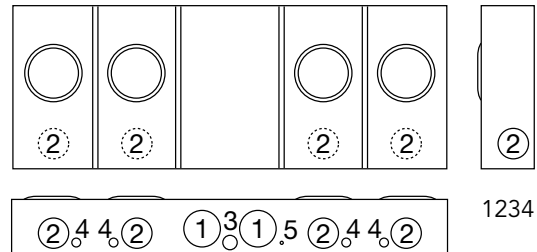
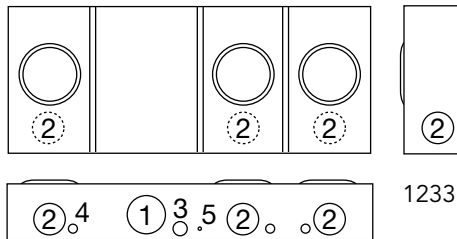
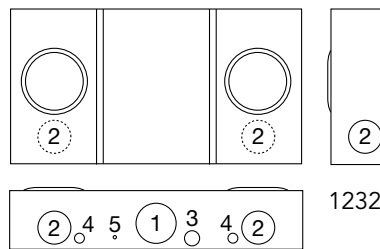

150 Amps per Position | 4 Terminals | Multi-Position | Horn Bypass | Ringless

Catalog Number	Positions	Service	Hub	Connectors CU/AL		Dimensions			Knockouts				
				Line	Load	D"	W"	H"	1	2	3	4	5
U1232-RRL-KK-K1	2	OH/UG	H.O.	#6-350	#6-350	5½	26½	14	3	2½	1	½	¼
U1233-RRL-KK-K1	3	OH/UG	H.O.	#6-350	#6-350	5½	34¾	14	3	2½	1	½	¼
U1234-RXL-KK-K1	4	OH/UG	C.P.	#6-350	#6-350	5½	42⅞	16	3	2½	1	½	¼

Notes

- **Hubs:** For proper hub selection, refer to the hub suffix chart on the accessories page. For the **U1254-6**, two hub openings are supplied and the extra opening is closed with a closing plate as standard.
- **Fifth Terminal:** For field-installable fifth terminal, order catalog number **K5T** (9 o'clock position).



Please consult serving utility for their requirements prior to ordering or installing, as specifications and approvals vary by utility, and may require local electrical inspector approval. All installations must be installed by a licensed electrician and must comply with all national and local codes, laws and regulations. Milbank reserves the right to make changes in specifications and features shown without notice or obligation.

Multi-Position Sockets

200 Amps | 4 Terminals | Ringless | 300 VAC



U1252-RRL-KK-K1-SLVG

200 Amps per Position | 4 Terminals | Multi-Position | Horn Bypass | Ringless

Catalog Number	Positions	Service	Hub	Connectors CU/AL		Dimensions		
				Line	Load	D"	W"	H"
U1252-RRL-KK-K1-SLVG	2	OH/UG	H.O.	#6-350	#6-350	5 $\frac{1}{8}$	26 $\frac{1}{2}$	14
U1252-RRL-KK-K1-BLG-SLVG*	2	OH/UG	H.O.	#6-350	#6-350	5 $\frac{1}{8}$	26 $\frac{1}{2}$	14
U1253-RRL-KK-K1-SLVG	3	OH/UG	H.O.	#6-350	#6-350	5 $\frac{1}{8}$	34 $\frac{3}{4}$	14
U1253-RRL-KK-K1-BLG-SLVG*	3	OH/UG	H.O.	#6-350	#6-350	5 $\frac{1}{8}$	34 $\frac{3}{4}$	14
U1254-RXL-KK-K1-SLVG	4	OH/UG	C.P.	#6-350	#6-350	5 $\frac{1}{8}$	42 $\frac{7}{8}$	16
U1254-RXL-KK-K1-BLG-SLVG*	4	OH/UG	H.O.	#6-350	#6-350	5 $\frac{1}{8}$	42 $\frac{7}{8}$	16
U1255-RXL-KK-K1-SLVG	5	OH/UG	C.P.	#6-350	#6-350	5 $\frac{1}{8}$	54 $\frac{1}{2}$	16
U1255-RXL-KK-K1-BLG-SLVG*	5	OH/UG	H.O.	#6-350	#6-350	5 $\frac{1}{8}$	54 $\frac{1}{2}$	16
U1256-RXL-KK-K1-SLVG	6	OH/UG	C.P.	#6-350	#6-350	5 $\frac{1}{8}$	63 $\frac{1}{16}$	18
U1256-RXL-KK-K1-BLG-SLVG*	6	OH/UG	H.O.	#6-350	#6-350	5 $\frac{1}{8}$	63 $\frac{1}{16}$	18

Notes

- **Hubs:** For proper hub selection, refer to the hub suffix chart on the accessories page. For the **U1254-6**, two hub openings are supplied and the extra opening is closed with a closing plate as standard.
- **Fifth Terminal:** For field-installable fifth terminal, order catalog number **K5T** (9 o'clock position).

*Product numbers with **-BLG** are used in AEP service areas.

Please consult serving utility for their requirements prior to ordering or installing, as specifications and approvals vary by utility, and may require local electrical inspector approval. All installations must be installed by a licensed electrician and must comply with all national and local codes, laws and regulations. Milbank reserves the right to make changes in specifications and features shown without notice or obligation.



Knockouts				
1	2	3	4	5
3	2½	1	½	¼

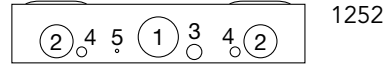
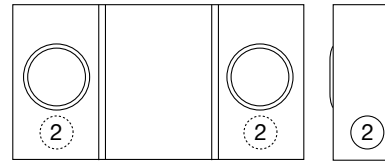

1252

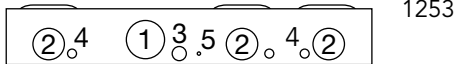
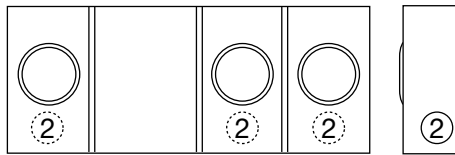

1253

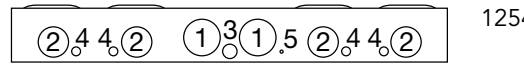
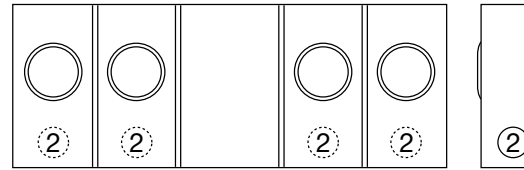

1254

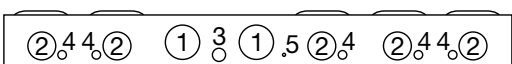
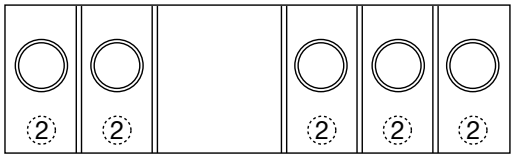

1255

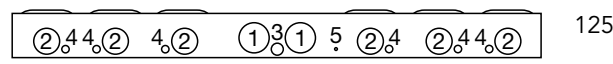
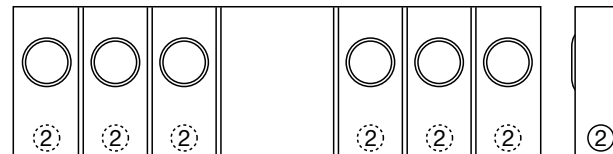

1256



Please consult serving utility for their requirements prior to ordering or installing, as specifications and approvals vary by utility, and may require local electrical inspector approval. All installations must be installed by a licensed electrician and must comply with all national and local codes, laws and regulations. Milbank reserves the right to make changes in specifications and features shown without notice or obligation.

Lever Bypass Multi-Position Sockets

23

200 Amps | 5 Terminals | Ringless | 600 VAC



U2873-XT

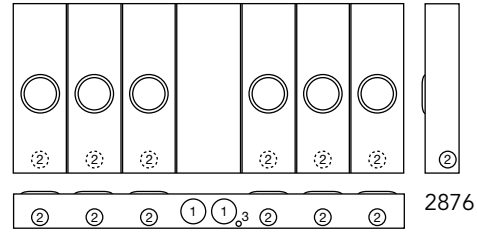
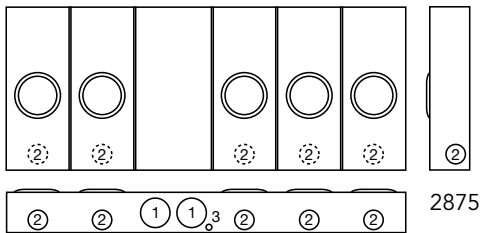
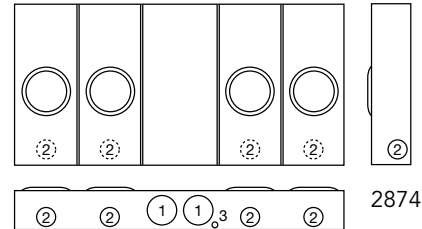
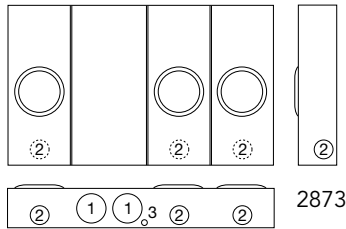
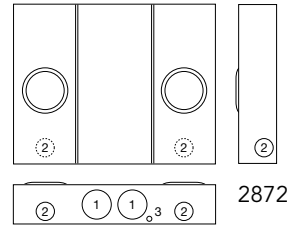

200 Amps per Position | 5 Terminals | Multi-Position | Ringless | OH/UG

Catalog Number	Positions	Hub	Connectors CU/AL		Bypass	Dimensions			Knockouts		
			Line	Load		D"	W"	H"	1	2	3
U2872-XT	2	(2) C.P.	3/8" x 16 Studs	#6-350	Lever	6	32 3/8	25 1/4	4	2 1/2	1/4, 1/2
U2873-XT	3	(2) C.P.	3/8" x 16 Studs	#6-350	Lever	6	42 3/16	25 1/4	4	2 1/2	1/4, 1/2
U2874-XT	4	(2) C.P.	3/8" x 16 Studs	#6-350	Lever	6	52 1/4	25 1/4	4	2 1/2	1/4, 1/2
U2875-XT	5	(2) C.P.	3/8" x 16 Studs	#6-350	Lever	6	62 5/16	25 1/4	4	2 1/2	1/4, 1/2
U2876-XT	6	(2) C.P.	3/8" x 16 Studs	#6-350	Lever	6	72 3/8	31 1/4	4	2 1/2	1/4, 1/2

Notes

- **Hubs:** Units supplied with two closing plates. To order hubs as extra, refer to the hub suffix chart on the accessories page.
- **Connector Kits:** For line side connector kits, order as extra **K1539** (single 350 kcmil), **K1540** (single 600 kcmil), **K1350** (twin 350 kcmil) **K1541** (twin 600 kcmil) Line connectors can be reversed to change from "OH" to "UG" service. For line side connector lug kits, order as extra from chart on the accessories page.
- **Bypass:** Lever supplies clamping action on meter spades and also operates bypass device.

Please consult serving utility for their requirements prior to ordering or installing, as specifications and approvals vary by utility, and may require local electrical inspector approval. All installations must be installed by a licensed electrician and must comply with all national and local codes, laws and regulations. Milbank reserves the right to make changes in specifications and features shown without notice or obligation.



24

Lever Bypass Multi-Position Sockets

200 Amps | 7 Terminals | Ringless | 600 VAC | 3 Phase

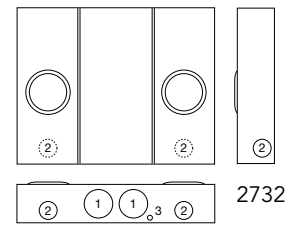

U2732-XT

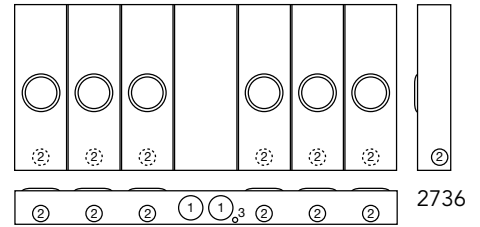
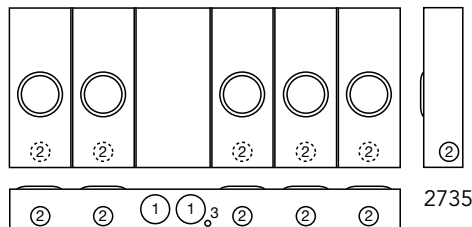
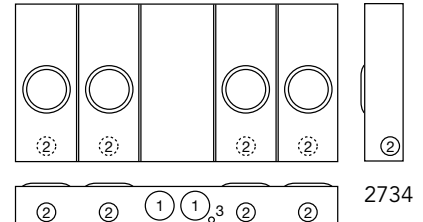
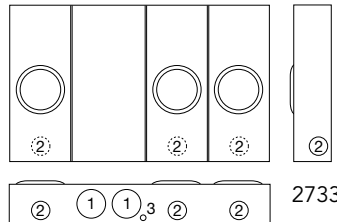

200 Amps per Position | 7 Terminals | Multi-Position | Lever Bypass | Ringless | OH/UG

Catalog Number	Positions	Hub	Connectors CU/AL		Dimensions			Knockouts		
			Line	Load	D"	W"	H"	1	2	3
U2732-XT	2	(2) C.P.	3/8" x 16 Studs	#6-350	6	32 1/8"	25 1/4"	4	2 1/2"	1/4, 1/2"
U2733-XT	3	(2) C.P.	3/8" x 16 Studs	#6-350	6	42 3/16"	25 1/4"	4	2 1/2"	1/4, 1/2"
U2734-XT	4	(2) C.P.	3/8" x 16 Studs	#6-350	6	52 1/4"	25 1/4"	4	2 1/2"	1/4, 1/2"
U2735-XT	5	(2) C.P.	3/8" x 16 Studs	#6-350	6	62 3/16"	25 1/4"	4	2 1/2"	1/4, 1/2"
U2736-XT	6	(2) C.P.	3/8" x 16 Studs	#6-350	6	72 3/8"	31 1/4"	4	2 1/2"	1/4, 1/2"

Notes

- **Hubs:** Units supplied with two closing plates. To order hubs as extra, refer to the hub suffix chart on the accessories page.
- **Connector Kits:** For line side connector kits, order as extra **K3082** (single 350 kcmil), **K3441** (single 600 kcmil), **K3442** (twin 350 kcmil), **K3083** (twin 600 kcmil). Line connectors can be reversed to change from "OH" to "UG" service.
- **Bypass:** Lever supplies clamping action on meter spades and also operates bypass device.



Please consult serving utility for their requirements prior to ordering or installing, as specifications and approvals vary by utility, and may require local electrical inspector approval. All installations must be installed by a licensed electrician and must comply with all national and local codes, laws and regulations. Milbank reserves the right to make changes in specifications and features shown without notice or obligation.

Lever Bypass Multi-Position Sockets

25

200 Amps | 5 Terminals | Ringless



U4374-Xt-5T9

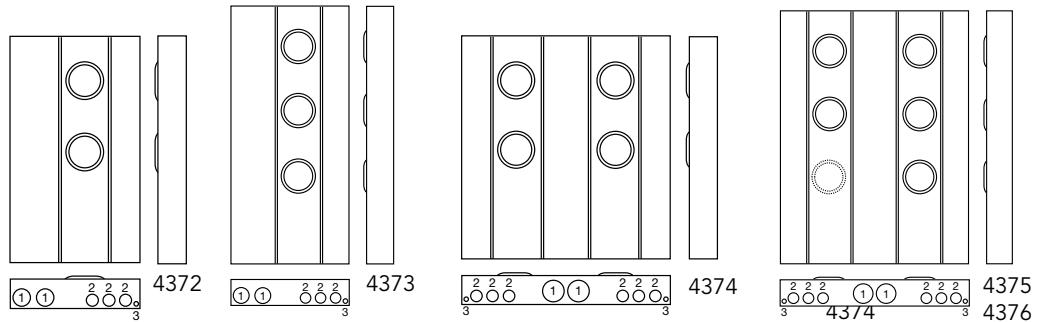

200 Amps | 5 Terminals | Multi-Position | Lever Bypass | Ringless

Catalog Number	Positions	Main Bus Rating	Line Connector Size	Dimensions			Knockouts		
				D"	W"	H"	1	2	3
U4372-Xt-5T9	2	320 Amps	3/8" x 16 Studs	6	27 3/4	48	3	2	1/4, 1/2
U4373-Xt-5T9	3	480 Amps	3/8" x 16 Studs	6	27 3/4	60	3	2	1/4, 1/2
U4374-Xt-5T9	4	640 Amps	3/8" x 16 Studs	6	45	48	3	2	1/4, 1/2
U4375-Xt-5T9	5	640 Amps	3/8" x 16 Studs	6	45	60	3	2	1/4, 1/2
U4376-Xt-5T9	6	640 Amps	3/8" x 16 Studs	6	45	60	3	2	1/4, 1/2

Connector Kits

Size	Suffix	Kit Number	Compatible With	Wire Range
Single	-K1	K1539	U2852-56, U2862-66	#6-350
	-K3	K1540	U2854-56, U2864-66	#4-600
Twin	-K2	K1350	U2854-56, U2863-66	#6-350
	-K4	K1541	U2864-66	#2-600

Breaker Chart

Manufacturer	150-200 Amps	125 Amps or Less
Milbank	WBJ	—
Cutler-Hammer	BR, BJ	Quicklag P, BR, HQP
Siemens	QNR	QP
Siemens/Murray	MD	MP
GE	Q Line	Q Line
Square D	—	Homeline

Notes

- **Connectors:** For line wire connector kits, order separately (see chart above).
- **Breakers:** Units have provision for one 2-pole main per meter position. Breakers not included. Order as extra (see chart above).
- **Bypass:** Lever supplies clamping action on meter spades and also operates bypass device.
- **Short Circuit Current Rating:** 10K AIC. However, this rating is limited to the lowest interrupting capacity of any circuit breaker installed. Watt-hour meter not included in short circuit current rating.

Please consult serving utility for their requirements prior to ordering or installing, as specifications and approvals vary by utility, and may require local electrical inspector approval. All installations must be installed by a licensed electrician and must comply with all national and local codes, laws and regulations. Milbank reserves the right to make changes in specifications and features shown without notice or obligation.



Multi-Position Meter Mains

125-200 Amps per Position | 4 Terminals | Ringless | 120/240 VAC



U2854-X

(Order circuit breakers separately)



U2866-X

125 Amps per Position | 4 Terminals | Multi-Position | Ringless

Catalog Number	Amps Per Position	Positions	Main Bus Rating	Line Connector Size	Dimensions		
					D"	W"	H"
U2852-X	125	2	200 Amps	3/8" x 16 Studs	5 13/16	18	25
U2853-X	125	3	200 Amps	3/8" x 16 Studs	5 13/16	18	37
U2854-X	125	4	400 Amps	3/8" x 16 Studs	4 7/8	31	25
U2855-X	125	5	400 Amps	3/8" x 16 Studs	4 7/8	31	37
U2856-X	125	6	400 Amps	3/8" x 16 Studs	4 7/8	31	37

200 Amps per Position | 4 Terminals | Multi-Position | Ringless

Catalog Number	Amps Per Position	Positions	Main Bus Rating	Line Connector Size	Dimensions		
					D"	W"	H"
U2862-X	200	2	250 Amps	3/8" x 16 Studs	5 13/16	21	29
U2863-X	200	3	300 Amps	3/8" x 16 Studs	5 13/16	21	41
U2864-X	200	4	400 Amps	3/8" x 16 Studs	4 7/8	36	29
U2865-X	200	5	600 Amps	3/8" x 16 Studs	4 7/8	36	41
U2866-X	200	6	600 Amps	3/8" x 16 Studs	4 7/8	36	41

Connector Kits

Size	Suffix	Kit Number	Compatible With	Wire Range
Single	-K1	K1539	U2852-56, U2862-66	#6-350
	-K3	K1540	U2854-56, U2864-66	#4-600
Twin	-K2	K1350	U2854-56, U2863-66	#6-350
	-K4	K1541	U2864-66	#2-600

Breaker Chart

Manufacturer	150-200 Amps	125 Amps or Less
Milbank	WBJ	—
Cutler-Hammer	BR, BJ	Quicklag P, BR, HQP
Siemens	QNR	QP
Siemens/Murray	MD	MP
GE	Q Line	Q Line
Square D	—	Homeline

Notes

- **Connectors:** For line wire connector kits, order separately.
- **Fifth Terminal:** For field-installable fifth terminal, order catalog number **K2381**. Order one per meter position.
- **Breakers:** Units have provision for one 2-pole main per meter position. Breakers not included. Order as extra (see chart above).
- **Short Circuit Current Rating:** 10K AIC. However, this rating is limited to the lowest interrupting capacity of any circuit breaker installed. Watt-hour meter not included in short circuit current rating.
- **Knockouts:** See next page for drawings and knockout configurations.



Please consult serving utility for their requirements prior to ordering or installing, as specifications and approvals vary by utility, and may require local electrical inspector approval. All installations must be installed by a licensed electrician and must comply with all national and local codes, laws and regulations. Milbank reserves the right to make changes in specifications and features shown without notice or obligation.

Multi-Position Meter Mains

Knockout Information

Catalog Number	Knockouts		
	1	2	3
U2852-X	3	1¼	¼, ½
U2853-X	3	1¼	¼, ½
U2854-X	3	1¼	¼, ½
U2855-X	3	1¼	¼, ½
U2856-X	3	1¼	¼, ½
U2862-X	3	2	¼, ½
U2863-X	3	2	¼, ½
U2864-X	3	2	¼, ½
U2865-X	3	2	¼, ½
U2866-X	3	2	¼, ½

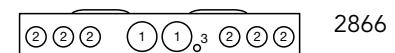
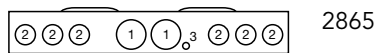
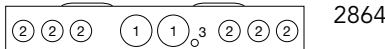
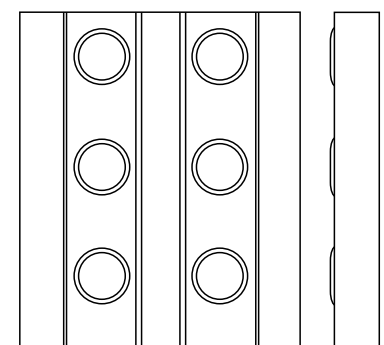
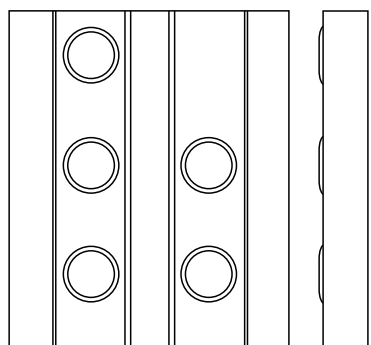
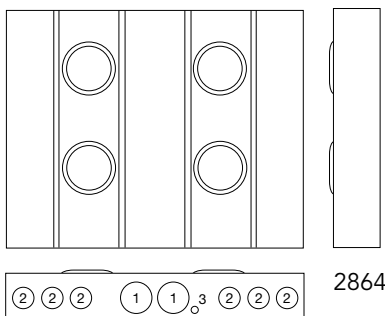
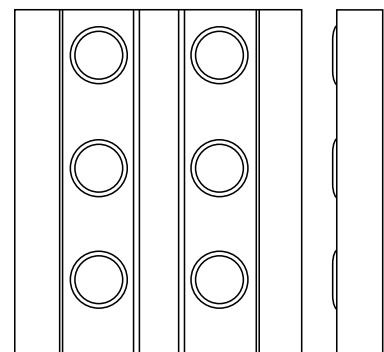
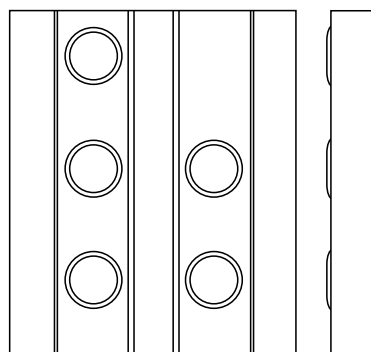
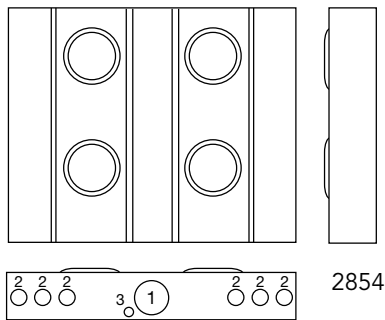
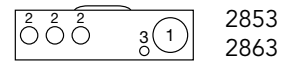
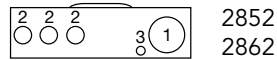
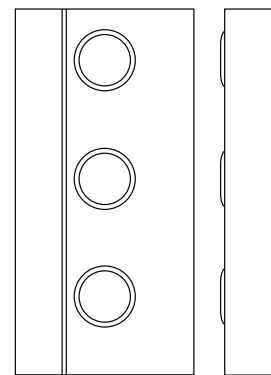
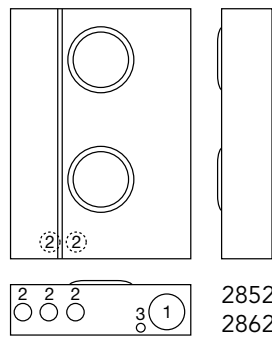

Please consult serving utility for their requirements prior to ordering or installing, as specifications and approvals vary by utility, and may require local electrical inspector approval. All installations must be installed by a licensed electrician and must comply with all national and local codes, laws and regulations. Milbank reserves the right to make changes in specifications and features shown without notice or obligation.



Multi-Position Meter Mains

125-200 Amps | 4 Terminals | Ringless | 120/240 VAC | 22K AIC



U5882-X-KK-BLG



U5884-X-KK-BLG

125 Amps per Position | 4 Terminals | Multi-Position Meter Mains | Ringless

Catalog Number	Amps	Positions	Service	Hub	Connectors CU/AL	Bypass	Dimensions		
					Line		D"	W"	H"
U5902-X-KK-BLG	125	2	OH/UG	C.P.	3/8" x 16 Studs	Horn	5 1/8"	26 1/2"	30"
U5903-X-KK-BLG	125	3	OH/UG	C.P.	3/8" x 16 Studs	Horn	5 1/8"	34 5/8"	30"
U5904-X-KK-BLG	125	4	OH/UG	C.P.	3/8" x 16 Studs	Horn	5 1/8"	42 5/8"	30"
U5905-X-KK-BLG	125	5	OH/UG	C.P.	3/8" x 16 Studs	Horn	5 1/8"	51 1/20"	30"
U5906-X-KK-BLG	125	6	OH/UG	C.P.	3/8" x 16 Studs	Horn	5 1/8"	59 3/10"	30"

200 Amps per Position | 4 Terminals | Multi-Position Meter Mains | Ringless

Catalog Number	Amps	Positions	Service	Hub	Weight (lbs.)	Connectors CU/AL	Bypass	Dimensions		
						Line		D"	W"	H"
U5882-X-KK-BLG	200	2	OH/UG	C.P.	58	3/8" x 16 Studs	Horn	5 1/8"	26 1/2"	30"
U5883-X-KK-BLG	200	3	OH/UG	C.P.	88	3/8" x 16 Studs	Horn	5 1/8"	34 5/8"	30"
U5884-X-KK-BLG	200	4	OH/UG	C.P.	107	3/8" x 16 Studs	Horn	5 1/8"	42 5/8"	30"
U5885-X-KK-BLG	200	5	OH/UG	C.P.	128	3/8" x 16 Studs	Horn	5 1/8"	51 1/20"	30"
U5886-X-KK-BLG	200	6	OH/UG	C.P.	146	3/8" x 16 Studs	Horn	5 1/8"	59 3/10"	30"

Notes

- **Knockouts:** See drawings on the next page.
- **Optional:** Factory installed breakers are available — consult factory for more information.
- **AIC Rating:** All models are rated 22K AIC when used with approved breakers rated at 22K.
- **Hub:** Units supplied with one closing plate. To order hubs separately, see the hub suffix chart on the accessories page.
- **Fifth Terminal:** For field-installable fifth terminal, order **K5T**.
- **Connectors:** Socket is supplied with 3/8" - 16 hex head nuts with Belleville washers. For connector lug kits, order as extra from chart on the accessories page. Separate lug kits are required for line and load.



Please consult serving utility for their requirements prior to ordering or installing, as specifications and approvals vary by utility, and may require local electrical inspector approval. All installations must be installed by a licensed electrician and must comply with all national and local codes, laws and regulations. Milbank reserves the right to make changes in specifications and features shown without notice or obligation.

Multi-Position Meter Mains

Knockout Information

Knockouts				
1	2	3	4	5
3	2½	1	¾	¼

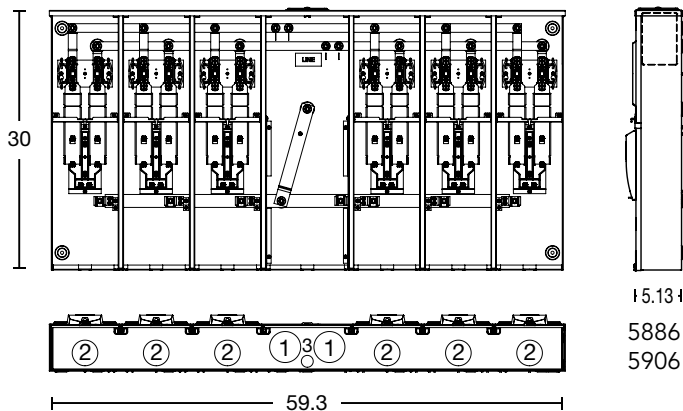
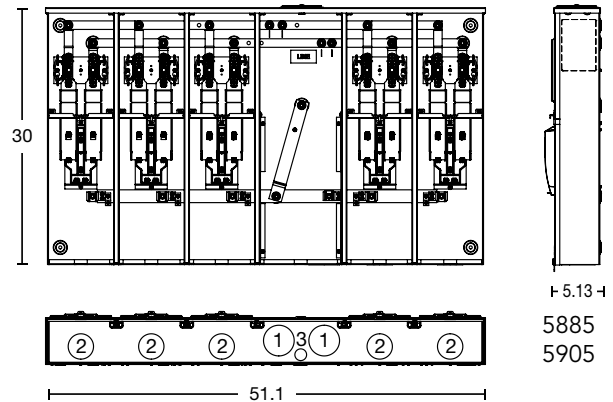
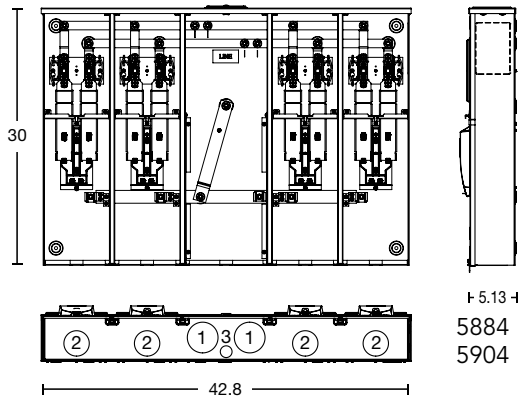
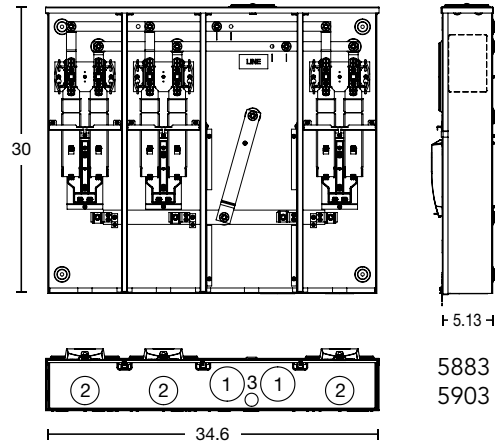
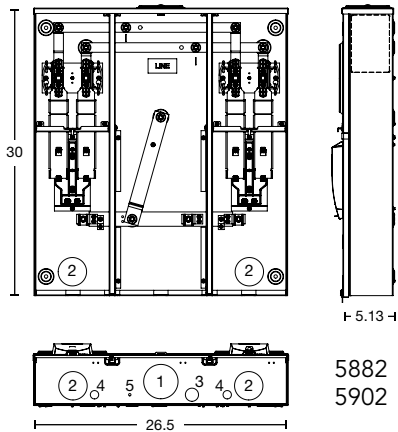

Please consult serving utility for their requirements prior to ordering or installing, as specifications and approvals vary by utility, and may require local electrical inspector approval. All installations must be installed by a licensed electrician and must comply with all national and local codes, laws and regulations. Milbank reserves the right to make changes in specifications and features shown without notice or obligation.





UC7235

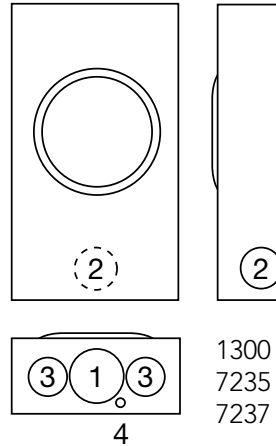

1-Piece Cover | Transformer Rated | Ringless | OH/UG

Catalog Number	Terminals	Type	Hub	Meter Form	Connectors CU	Dimensions			Knockouts			
						D"	W"	H"	1	2	3	4
UC1299-RL	6	Ringless	H.O.	4S	#14-#4 MAX	3 ⁵ / ₁₆	8	14	2	1 ¹ / ₂	1 ¹ / ₄	1 ¹ / ₄
UC7235-RL	8	Ringless	H.O.	5S	#14-#4 MAX	3 ⁵ / ₁₆	8	14	2	1 ¹ / ₂	1 ¹ / ₄	1 ¹ / ₄
UC7237-XL	13	Ringless	C.P.	6, 8, 9	#14-#4 MAX	3 ⁵ / ₁₆	8	14	2	1 ¹ / ₂	1 ¹ / ₄	1 ¹ / ₄

1-Piece Cover | Transformer Rated | Ringless | OH/UG

Catalog Number	Terminals	Type	Hub	Meter Form	Connectors CU	Dimensions			Knockouts			
						D"	W"	H"	1	2	3	4
UC1300-RL	6	Ring Type	H.O.	4S	#14-#4 MAX	3 ⁵ / ₁₆	8	14	2	1 ¹ / ₂	1 ¹ / ₄	1 ¹ / ₄

Notes

- **Hubs:** For proper hub selection, see the hub suffix chart on the accessories page.



Please consult serving utility for their requirements prior to ordering or installing, as specifications and approvals vary by utility, and may require local electrical inspector approval. All installations must be installed by a licensed electrician and must comply with all national and local codes, laws and regulations. Milbank reserves the right to make changes in specifications and features shown without notice or obligation.

Transformer Rated

20 Amps | Test Switch Provision

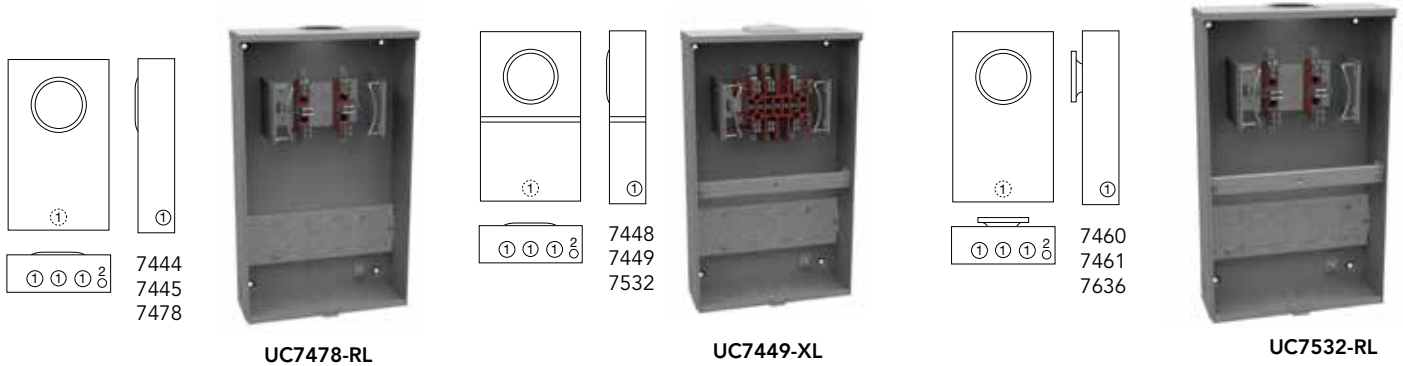

1-Piece Cover | Transformer Rated with Test Switch Provision | Ringless | OH/UG

Catalog Number	Terminals	Hub	Meter Form	Connectors CU	Bypass	Dimensions			Knockouts	
						D"	W"	H"	1	2
UC7478-RL	6	H.O.	4S	#14 - #4 Max	None	4 $\frac{1}{8}$	12	20	1 $\frac{1}{4}$	$\frac{1}{4}$, $\frac{1}{2}$
UC7444-RL	8	H.O.	5S	#14 - #4 Max	None	4 $\frac{1}{8}$	12	20	1 $\frac{1}{4}$	$\frac{1}{4}$, $\frac{1}{2}$
UC7445-RL	13	H.O.	6, 8, 9	#14 - #4 Max	None	4 $\frac{1}{8}$	12	20	1 $\frac{1}{4}$	$\frac{1}{4}$, $\frac{1}{2}$
UC7445-RL-641*	13	H.O.	6, 8, 9	#14 - #4 Max	None	4 $\frac{1}{8}$	12	20	1 $\frac{1}{4}$	$\frac{1}{4}$, $\frac{1}{2}$
UC7445-WL	13	1 in	6, 8, 9	#14 - #4 Max	None	4 $\frac{1}{8}$	12	20	1 $\frac{1}{4}$	$\frac{1}{4}$, $\frac{1}{2}$

2-Piece Cover | Transformer Rated with Test Switch Provision | No Bypass | OH/UG

Ringless Catalog Number	Ring Type Catalog Number	Terminals	Meter Form	Hub	Connectors CU	Dimensions			Knockouts	
						D"	W"	H"	1	2
UC7532-RL	UC7636-RL	6	4S	H.O.	#14 - #4 Max	4 $\frac{1}{8}$	12	20	1 $\frac{1}{4}$	$\frac{1}{4}$, $\frac{1}{2}$
UC7448-RL	UC7460-RL	8	5S	H.O.	#14 - #4 Max	4 $\frac{1}{8}$	12	20	1 $\frac{1}{4}$	$\frac{1}{4}$, $\frac{1}{2}$
UC7449-RL	UC7461-RL	13	6, 8, 9	H.O.	#14 - #4 Max	4 $\frac{1}{8}$	12	20	1 $\frac{1}{4}$	$\frac{1}{4}$, $\frac{1}{2}$

Notes

- **Hubs:** For proper hub selection, see the hub suffix chart on the accessories page.
- **Sealing Rings:** Ring type units are supplied with one **MR-2**, snap type sealing ring.
- **Prewiring:** Factory prewiring available.
- **Connectors:** Units are supplied with mechanical type connectors (#4 max). If compression type connectors (#10) are preferred, change catalog prefix to **S** (i.e., **UC7445-XL** becomes **S7445-XL**). The **S** prefix also designates not UL listed.

*Prewired per Lebanon specifications.

Please consult serving utility for their requirements prior to ordering or installing, as specifications and approvals vary by utility, and may require local electrical inspector approval. All installations must be installed by a licensed electrician and must comply with all national and local codes, laws and regulations. Milbank reserves the right to make changes in specifications and features shown without notice or obligation.



Lever Bypass Transformer Rated

80 Amps | 6, 8 & 13 Terminals



U4490-XL

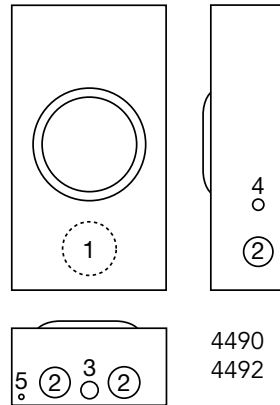

80 Amps | Transformer Rated | Lever Bypass | Ringless

Catalog Number	Terminals	Service	Hub	Meter Form	Connectors CU	Dimensions			Knockouts				
						D"	W"	H"	1	2	3	4	5
U4490-XL	6	OH/UG	C.P.	4S	#14 - #4 Max	4 ⁷ / ₈	10	18 ¹ / ₂	3	1 ¹ / ₂	1 ¹ / ₂ , ³ / ₄	³ / ₄	¹ / ₄
U4492-XL	8	OH/UG	C.P.	5S	#14 - #4 Max	4 ⁷ / ₈	10	18 ¹ / ₂	3	1 ¹ / ₂	1 ¹ / ₂ , ³ / ₄	³ / ₄	¹ / ₄
U4493-XL	13	OH/UG	C.P.	6, 8, 9	#14 - #4 Max	4 ⁷ / ₈	10	18 ¹ / ₂	3	1 ¹ / ₂	1 ¹ / ₂ , ³ / ₄	³ / ₄	¹ / ₄

Notes

- **Hubs:** For proper hub selection, see the hub suffix chart on the accessories page.
- **Bypass:** Lever operates current bypass device and also supplies clamping action on current meter spades.
- **Connectors:** Units are supplied with mechanical type connectors (#4 max).



Please consult serving utility for their requirements prior to ordering or installing, as specifications and approvals vary by utility, and may require local electrical inspector approval. All installations must be installed by a licensed electrician and must comply with all national and local codes, laws and regulations. Milbank reserves the right to make changes in specifications and features shown without notice or obligation.

Test Switches

4, 7 & 10 Pole

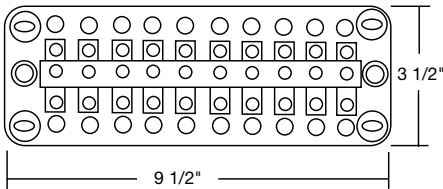
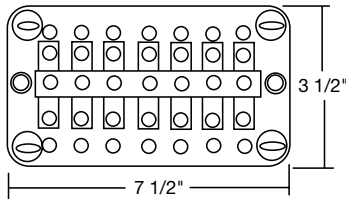
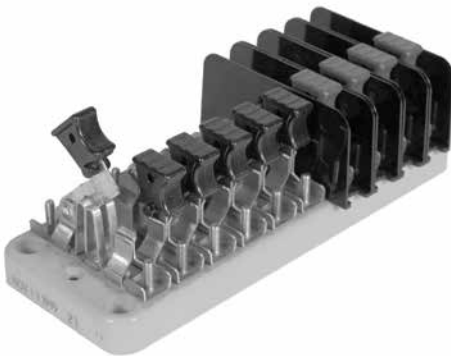

Catalog Number	4-Pole						
TS04-0101	X	P	[Pn]	X	C+	C	X
TS04-0102	X	[P]	C+	C	X	Pn	X
TS04-0103	X	P	[Pn]	X	C	C+	X
TS04-0104	X	C+	C	X	P	[Pn]	X

Notes

- 4-pole switches are also available on 10-pole bases. Contact Milbank for appropriate catalog numbers.

Catalog Number	7-Pole						
TS07-0105	[P]	P	[Pn]	C+	C	C+	C
TS07-0106	[P]	C+	C	[P]	C+	C	[Pn]
TS07-0107	[P]	P	[Pn]	C	C+	C	C+
TS07-0108	C+	C	C+	C	[P]	P	[Pn]

Catalog Number	7-Pole on a 10-Pole Base									
TS07-0049	[P]	X	[P]	X	[Pn]	X	C+	C	C	C+
TS07-0018	[P]	X	[P]	X	[Pn]	X	C+	C	C+	C
TS07-0059	X	[P]	C+	C	[P]	C	C+	[Pn]	X	X
TS07-0022	P	X	P	X	Pn	X	C	C+	C	C+

Key	
P	Potential switch
C+	Line side current switch with short circuit assembly
C	Load side current switch with test jack assembly
N	Neutral bar (no switch)
Pn	Neutral potential switch
X	Unused position on base
[]	Insulating barrier, isolates both sides of switch

Catalog Number	10-Pole									
TS10-0109	P	[P]	P	[Pn]	C+	C	C+	C	C+	C
TS10-0110	[P]	C+	C	[P]	C+	C	[P]	C+	C	[Pn]
TS10-0111	P	[P]	P	[Pn]	C	C+	C	C+	C	C+
TS10-0112	C+	C	C+	C	C+	C	[P]	P	[P]	[Pn]

Please consult serving utility for their requirements prior to ordering or installing, as specifications and approvals vary by utility, and may require local electrical inspector approval. All installations must be installed by a licensed electrician and must comply with all national and local codes, laws and regulations. Milbank reserves the right to make changes in specifications and features shown without notice or obligation.





Customer Name: _____

Email: _____

Phone: _____

Handle Color Key							
BK	Black	P	Purple	Y	Yellow	GN	Green
R	Red	BL	Blue	W	White	BKS	Black Stripe
BR	Brown	GR	Gray	O	Orange	WS	White Stripe

TEST SWITCH BASE

The base is molded from a high strength, fiberglass reinforced, thermoset polyester. This material is track-resistant, flame-retardant and has low water absorption qualities. Bases are available in two standard sizes following NEMA mounting classifications.

Pole Position Chart

1	2	3	4	5	6	7	8	9	10

Special Features

Feature	1	2	3	4	5	6	7	8	9	10
45° Angle Stops										
Ganged Handles (C)										
Bussing										
Colored Handles										

Engineering Information: _____

Key	
P	Potential switch
C+	Line side current switch with short circuit assembly
C	Load side current switch with test jack assembly
N	Neutral bar (no switch)
Pn	Neutral potential switch
X	Unused position on base
L	Insulating barrier (one side)
□	Insulating barrier (two sides)

Custom Pole Arrangements: The key may be used to diagram your own pole arrangement. Be sure to specify base size and whether all C+ line side, current switch/shunt circuit assemblies are to be bussed together.

Number of Poles

- 4
- 7
- 10
- Other _____

Test Switch Cover (only available for 10-pole bases)

- Yes | Clear ___ Black ___
- No

Base Size

- 7-Pole
- 10-Pole



Please consult serving utility for their requirements prior to ordering or installing, as specifications and approvals vary by utility, and may require local electrical inspector approval. All installations must be installed by a licensed electrician and must comply with all national and local codes, laws and regulations. Milbank reserves the right to make changes in specifications and features shown without notice or obligation.

Current Transformer Cabinets

Panel Enclosure | NEMA 3R



304410-CTC3R

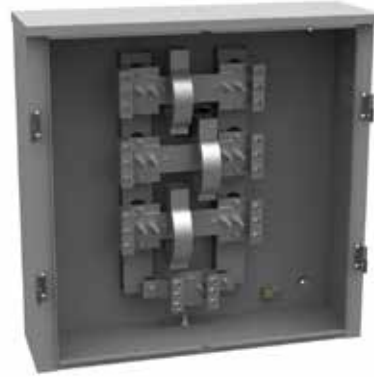

U5990-O

Outdoor Transformer Cabinets | NEMA 3R

Catalog Number	Dimensions			Gauge of Steel	Board Size		CT Mounting Provisions	# of Doors	Latching Type
	D"	W"	H"		W"	H"			
U4408-O	14	40	40	12	40	40	Wood	2	3 point latch
U4410-O	12	32	24		28	20	Wood	1	Flip latch
S4019-O	10	32	24	14	24	16	Wood	2	3 point latch
S4020-O	10	36	32	14	28	24	Wood	2	3 point latch
S4399-O	10	24	18	14	16	10	Wood	2	3 point latch
S4400-O	10	44	30	14	36	22	Wood	2	3 point latch
304410-CTC3R	10	44	30	12	—	—	None	2	Hasp
243210-CTC3R	10	32	24	14	—	—	None	2	Hasp
363612-LC3R-SP-WB	12	36	36	14	33	33	Rails	1	Wing handle
484812-CT3R-WB	12	48	48	14	44	44	Rails	2	3 point latch
U5990-O	10	36	36	12	CT mounting rack included			2	Flip latch

Notes

- **Features:** Supplied with solid back board when noted, three-point locking handle, lift off hinges with stainless steel pins and padlock provisions.
- **U5990-O:** is 3Ø with a 50K RMS rating, and has a wire range of #4-600 kcmil.
- **UL:** Non-UL listed.
- **Approvals:** See utility approval chart on page 62.

Please consult serving utility for their requirements prior to ordering or installing, as specifications and approvals vary by utility, and may require local electrical inspector approval. All installations must be installed by a licensed electrician and must comply with all national and local codes, laws and regulations. Milbank reserves the right to make changes in specifications and features shown without notice or obligation.



36 Meter Main with Load Center Pedestals

200 Amps | 4 Terminals | Ringless | 120/240 VAC

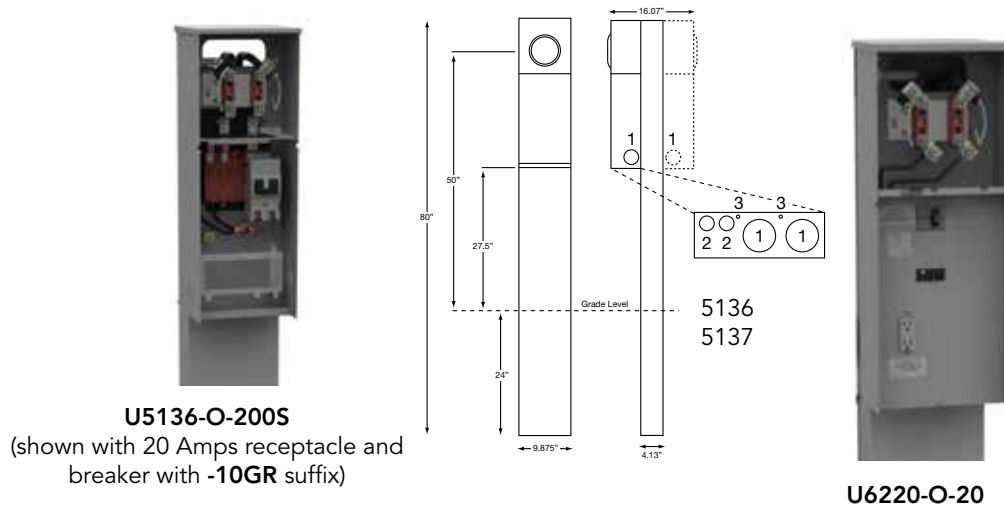

200 Amps | 4 Terminals | Meter Main Pedestals | Ringless

Catalog Number	Breaker Amps	Service	Powerheads	Branch Circuits	Bypass	Connectors CU/AL		Knockouts		
						Line	Load	1	2	3
U5136-O	Provision	UG	Single	4	Horn	#6-350	CB	2	1/2, 3/4	1/4
U5136-O-100S	100	UG	Single	4	Horn	#6-350	CB	2	1/2, 3/4	1/4
U5136-O-200S	200	UG	Single	4	Horn	#6-350	CB	2	1/2, 3/4	1/4
U5137-O-200S	200	UG	Double	4	Horn	#6-350	CB	2	1/2, 3/4	1/4

100-200 Amps | 4 Terminals | Meter Main Pedestals | Ringless

Catalog Number	Breaker Amps	Service	Powerheads	Branch Circuits	Bypass	Connectors CU/AL		Knockouts		
						Line	Load	1	2	3
U6220-O-100-KK-10GR	100	UG	Single	10	Horn	#6-350	FTL*	2	1/2, 3/4	1/4
U6220-O-200-KK-10GR	200	UG	Single	8	Horn	#6-350	FTL*	2	1/2, 3/4	1/4

Notes

- **Parallel to Series Conversion:** For field converting from parallel wired to series wired, order **K5194**.
- **Fifth Terminal:** For field-installable fifth terminal, order **K5T**.
- **Stabilizer Foot:** For field-installable stabilizer foot, order **K5415**.
- **Penta Bolt Locking:** For field-installable pedestal fronts with penta bolt locking, order **K5039**.
- **Receptacles:** Consult factory for installed receptacle assemblies.
- **Short Circuit Current Rating:** 22K AIC. However, this rating is limited to the lowest interrupting capacity of any circuit breaker installed. Watt-hour meter not included in short circuit current rating.

*Feed through lugs



Please consult serving utility for their requirements prior to ordering or installing, as specifications and approvals vary by utility, and may require local electrical inspector approval. All installations must be installed by a licensed electrician and must comply with all national and local codes, laws and regulations. Milbank reserves the right to make changes in specifications and features shown without notice or obligation.

Temporary Power Units

37

125 Amps | 4 Terminals | Ringless | 120/240 VAC

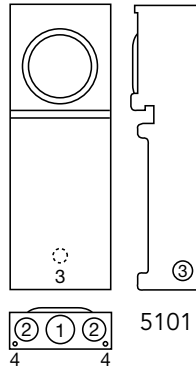

U5101-XL-11GR

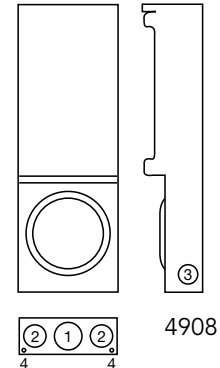

U4908-O-11GR

125 Amps | 4 Terminals | Temporary Power Units | Ringless | 1Ø3W

Catalog Number	Service	Hub	Connectors CU/AL		Dimensions			Knockouts					
			Line	Load	D"	W"	H"	1	2	3	4	5	
U5101-XL-11GR	OH	C.P.	#6-350	#6-350	5 ³ / ₁₆	8 ⁷ / ₈	25	2	1 ¹ / ₂	1 ¹ / ₄	1 ¹ / ₄	1 ¹ / ₄	—
U4908-O-11GR	UG	Blank	#6-2/0	#6-2/0	5 ³ / ₁₆	9	25 ¹⁵ / ₁₆	2	1 ¹ / ₂	1 ¹ / ₄	1 ¹ / ₄	1 ¹ / ₄	—

Notes

- **Interior:** Six circuit plated copper interior accepts standard plug-in type circuit breakers.
- **Receptacle Bridge:** Three position self-grounded receptacle bridge accepts most standard NEMA receptacles with mounting plates.
- **Included Parts:** U4908 and U5101 come supplied with two 20 Amps 1-pole breakers and two 20 Amps GFCI receptacles (prewired and installed).

Please consult serving utility for their requirements prior to ordering or installing, as specifications and approvals vary by utility, and may require local electrical inspector approval. All installations must be installed by a licensed electrician and must comply with all national and local codes, laws and regulations. Milbank reserves the right to make changes in specifications and features shown without notice or obligation.



Surface-Mount Power Outlet

Millennium Series | Metered & Unmetered | 120/240 VAC

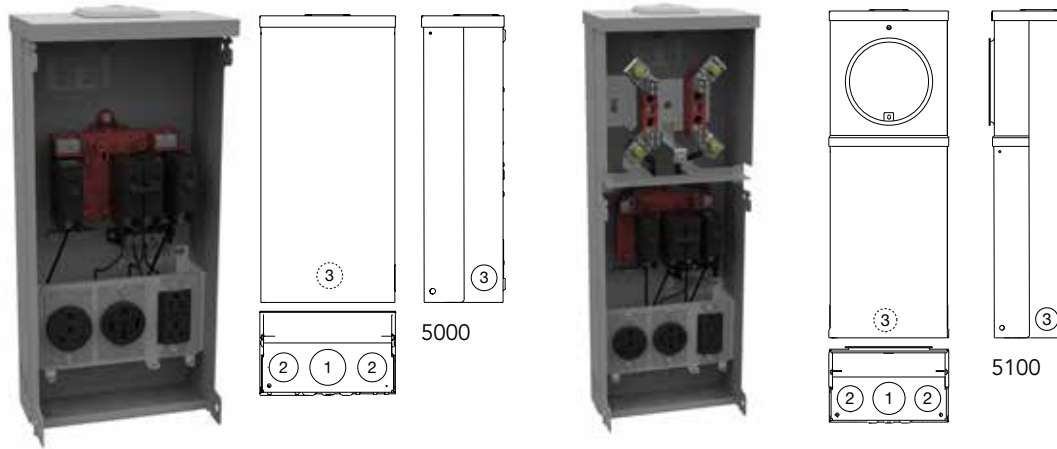

U5000-XL-75

U5100-XL-75

125 Amps | Surface-Mount Power Outlets

Catalog Number	Metered/Unmetered	Receptacle Configuration	Circuit Breaker Configuration	Loop Feed	Connectors - Line	Dimensions			Knockouts		
						D"	W"	H"	1	2	3
U5000-XL	Unmetered	—	—	Yes	(2) 1/0-#12	5½	9⅞	19¼	2	1½	1¼
U5000-XL-41	Unmetered	A	X	Yes	(2) 1/0-#12	5½	9⅞	19¼	2	1½	1¼
U5000-XL-55	Unmetered	B	Y	Yes	(2) 1/0-#12	5½	9⅞	19¼	2	1½	1¼
U5000-XL-75	Unmetered	C	Z	Yes	(2) 1/0-#12	5½	9⅞	19¼	2	1½	1¼
U5100-XL	Metered	—	—	No	#6-250	5½	9⅞	25	2	1½	1¼
U5100-XL-41	Metered	A	X	No	#6-250	5½	9⅞	25	2	1½	1¼
U5100-XL-55	Metered	B	Y	No	#6-250	5½	9⅞	25	2	1½	1¼
U5100-XL-75	Metered	C	Z	No	#6-250	5½	9⅞	25	2	1½	1¼

Receptacle Configurations

A	B	C
(1) TT30R, (1) 5-20R GFI	(1) 14-50R, (1) 5-20R GFI	(1) 14-50R, (1) TT30R, (1) 5-20R GFI

NOTE
Contact factory for additional configurations not shown here.

Circuit Breaker Configurations

X	Y	Z
(1) 30A, 1P, 120V (1) 20A, 1P, 120V	(1) 50A, 2P, 120/240V (1) 20A, 1P, 120V	(1) 50A, 2P, 120/240V (1) 30A, 1P, 120V (1) 20A, 1P, 120V



Please consult serving utility for their requirements prior to ordering or installing, as specifications and approvals vary by utility, and may require local electrical inspector approval. All installations must be installed by a licensed electrician and must comply with all national and local codes, laws and regulations. Milbank reserves the right to make changes in specifications and features shown without notice or obligation.

Power Outlet Pedestals

Millennium Series | Metered & Unmetered | 120/240 VAC

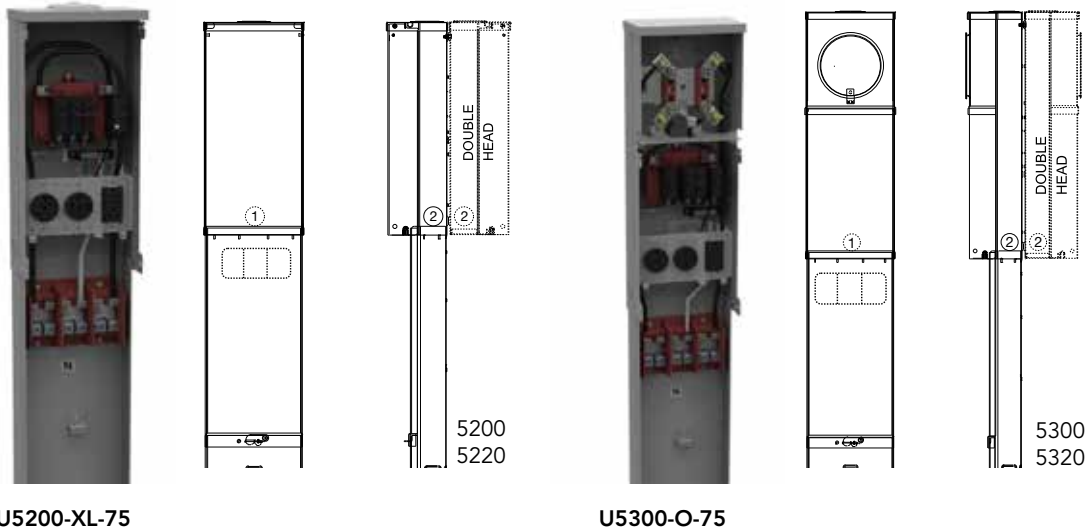

U5200-XL-75

U5300-O-75

125 Amps | Power Outlet Pedestals | Direct Burial

Catalog Number	Double Head Catalog Number	Metered/Unmetered	Receptacle Configuration	Circuit Breaker Configuration	Dimensions			Knockout
					D"	W"	H"	
U5200-XL	U5220-XL	Unmetered	—	—	5 ⁵ / ₁₆	9 ¹ / ₈	64 ¹ / ₂	1 ¹ / ₄
U5200-XL-41	U5220-XL-41	Unmetered	A	X	5 ⁵ / ₁₆	9 ¹ / ₈	64 ¹ / ₂	1 ¹ / ₄
U5200-XL-55	U5220-XL-55	Unmetered	B	Y	5 ⁵ / ₁₆	9 ¹ / ₈	64 ¹ / ₂	1 ¹ / ₄
U5200-XL-75	U5220-XL-75	Unmetered	C	Z	5 ⁵ / ₁₆	9 ¹ / ₈	64 ¹ / ₂	1 ¹ / ₄
U5300-O	U5320-O	Metered	—	—	5 ⁵ / ₁₆	9 ¹ / ₈	70 ¹ / ₄	1 ¹ / ₄
U5300-O-41	U5320-O-41	Metered	A	X	5 ⁵ / ₁₆	9 ¹ / ₈	70 ¹ / ₄	1 ¹ / ₄
U5300-O-55	U5320-O-55	Metered	B	Y	5 ⁵ / ₁₆	9 ¹ / ₈	70 ¹ / ₄	1 ¹ / ₄
U5300-O-75	U5320-O-75	Metered	C	Z	5 ⁵ / ₁₆	9 ¹ / ₈	70 ¹ / ₄	1 ¹ / ₄

Receptacle Configurations - Additional Configurations

A	B	C
(1) TT30R, (1) 5-20R GFI	(1) 14-50R, (1) 5-20R GFI	(1) 14-50R, (1) TT30R, (1) 5-20R GFI

Circuit Breaker Configurations

X	Y	Z
(1) 30A, 1P, 120V (1) 20A, 1P, 120V	(1) 50A, 2P, 120/240V (1) 20A, 1P, 120V	(1) 50A, 2P, 120/240V (1) 30A, 1P, 120V (1) 20A, 1P, 120V

NOTE

Contact factory for additional configurations not shown here.

Pad-mount is available — contact factory for information.

Please consult serving utility for their requirements prior to ordering or installing, as specifications and approvals vary by utility, and may require local electrical inspector approval. All installations must be installed by a licensed electrician and must comply with all national and local codes, laws and regulations. Milbank reserves the right to make changes in specifications and features shown without notice or obligation.





**UQFP
UQFPH**



**UQFP-M
UQFPH-M**



UQFB-X1



UQFBH

200 Amps Frame | Plug-In | 10K AIC & 22K AIC | 2-Pole - Common Trip

Amps	10K AIC Plug-In	22K AIC Plug-In	10K AIC Plug-In	22K AIC Plug-In	Wire Range	
					CU	AL
100	UQFP-100	UQFPH-100	UQFP-M-100	UQFPH-M-100	#3-#1	#1-1/0
125	UQFP-125	UQFPH-125	UQFP-M-125	UQFPH-M-125	#3-#1	#1-1/0
150	UQFP-150	UQFPH-150	UQFP-M-150	UQFPH-M-150	1/0-300	2/0-300
175	UQFP-175	UQFPH-175	UQFP-M-175	UQFPH-M-175	1/0-300	2/0-300
200	UQFP-200	UQFPH-200	UQFP-M-200	UQFPH-M-200	1/0-300	2/0-300

200 Amps Frame | Bolt-On | 10K AIC & 22K AIC | 2-Pole - Common Trip

Amps	10K AIC Bolt-On	22K AIC Bolt-On	10K AIC Bolt-On	22K AIC Bolt-On	Wire Range	
					CU	AL
100	UQFB-100	UQFBH-100	UQFB-100-X1	UQFBH-M-100	#3-#1	#1-1/0
125	UQFB-125	UQFBH-125	UQFB-125-X1	UQFBH-M-125	#3-#1	#1-1/0
150	UQFB-150	UQFBH-150	UQFB-150-X1	UQFBH-M-150	1/0-300	2/0-300
175	UQFB-175	UQFBH-175	UQFB-175-X1	UQFBH-M-175	1/0-300	2/0-300
200	UQFB-200	UQFBH-200	UQFB-200-X1	UQFBH-M-200	1/0-300	2/0-300

Notes

- **UL Listed:** For use with 60°C or 75°C wire.
- **UQFP:** For parallel main circuit breaker applications.
- **UQFP-M:** For series main circuit breaker applications. Split load tab features allow for feed-through capability.
- **UQFB:** (2) 1/0-300 lugs provided on load and line side (cable-in, cable-out).
- **UQFB3:** Three-pole available. Consult factory.
- **UQFB-X:** (2) 1/0-300 lugs provided on load side and (2) line bar bus connections on line side.
- **UQFB-M:** For series main circuit breaker applications. Split load tab features allow for feed-through capability.



Please consult serving utility for their requirements prior to ordering or installing, as specifications and approvals vary by utility, and may require local electrical inspector approval. All installations must be installed by a licensed electrician and must comply with all national and local codes, laws and regulations. Milbank reserves the right to make changes in specifications and features shown without notice or obligation.

Circuit Breakers

QP (small frame) and QN (large frame) | 120/240 VAC

15–125 Amps Breaker
Plug-In Type | 1" Per Pole

Amps	Poles	10K AIC Plug-In	22K AIC Plug-In
15	Single	Q115	Q115H
15	Double	Q215	Q215H
20	Single	Q120	Q120H
20	Double	Q220	Q220H
25	Single	Q125	Q125H
25	Double	Q225	Q225H
30	Single	Q130	Q130H
30	Double	Q230	Q230H
35	Single	Q135	Q135H
35	Double	Q235	Q235H
40	Single	Q140	Q140H
40	Double	Q240	Q240H
50	Single	Q150	Q150H
50	Double	Q250	Q250H
60	Single	Q160	Q160H
60	Double	Q260	Q260H
70	Single	Q170	Q170H
70	Double	Q270	Q270H
80	Double	Q280	Q280H
90	Double	Q290	Q290H
100	Double	Q2100	Q2100H
125	Double	Q2125	Q2125H



QN2200H



QN2200RH



WBJ2200



Q250

200 Amps Frame | Plug-In | 10K AIC & 22K AIC | 2-Pole, Common Trip

Amps	10K AIC Plug-In	22K AIC Plug-In	Handle Location	Wire Range	
				CU	AL
150	QN2150	QN2150H	Left facing	#4-300	#4-300
200	QN2200	QN2200H	Left facing	#4-300	#4-300
150	QN2150R	QN2150RH	Right facing	#4-300	#4-300
200	QN2200R	QN2200RH	Right facing	#4-300	#4-300
150	WBJ2150	—	Centered	#2-300	#2-300
200	WBJ2200	—	Centered	#2-300	#2-300

Notes

- **Breakers:** Load connectors supplied with breakers.
- **UL listed:** For use with 60°C or 75°C wire.
- **Wire sizes:** Wire sizes shown are lug capacity. Consult NEC Article #310 for specific wire sizes.

Please consult serving utility for their requirements prior to ordering or installing, as specifications and approvals vary by utility, and may require local electrical inspector approval. All installations must be installed by a licensed electrician and must comply with all national and local codes, laws and regulations. Milbank reserves the right to make changes in specifications and features shown without notice or obligation.



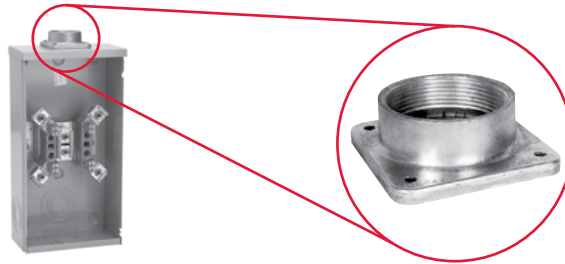
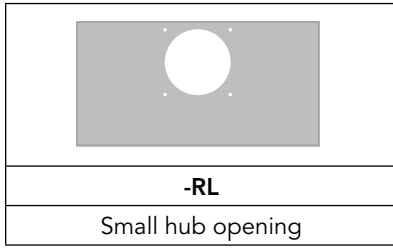

-WL A7514	-YL A7515	-ZL A7516	-DL A7517	-EL A7518	-XL A7551
1" hub	1¼" hub	1½" hub	2" hub	2½" hub	Small closing plate

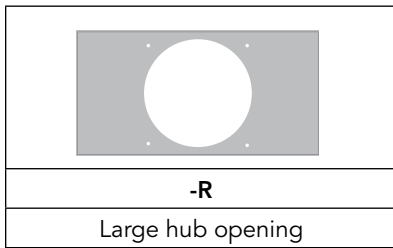

-F A8110	-G A8111	-H A8112	-X A9064	-RRL S8324	-RXL S8324 A7551
3" hub	3½" hub	4" hub	Large closing plate	Large hub opening adapted to small hub opening	Large hub opening adapted to small closing plate

Notes

- **Suffix:** Add to catalog number for factory installation of hub.
- **Packaging:** Individually packed units for field installation.
- **Abbreviations:** H.O. (hub opening), C.P. (closing plate).



Please consult serving utility for their requirements prior to ordering or installing, as specifications and approvals vary by utility, and may require local electrical inspector approval. All installations must be installed by a licensed electrician and must comply with all national and local codes, laws and regulations. Milbank reserves the right to make changes in specifications and features shown without notice or obligation.

Connector Kits, Closing Kits & Generator Interlock

Connector Kits — For Use with 3/8"-16 Stud Type Units Only

Single			Twin		
Suffix	Part #	(3 per set) - 1Ø	Suffix	Part #	(3 per set) - 1Ø
K1	K1539	6-350	K2	K1350	6-350
K3	K1540	4-600 or (2) 1/0-250*	K2L	K1350L	6-350 (non-rotating)
K3L	K1540L	4-600 or (2) 1/0-250* (non-rotating)	K4	K1541	4-600
Suffix	Part #	(4 per set) - 3Ø	Suffix	Part #	(4 per set) - 3Ø
K5	K3082	6-350	K6	K3442	6-350
K7	K3441	4-600 or (2) 1/0-250*	K8	K3083	4-600

*For (2) 1/0-250, conductors must be of same size.

Bypass Link



K8180 (sold in pairs)

Note

Consult factory for proper connector kits for studded meter sockets.

Closing Covers

Meter Closing Plate (Ring Type/Ringless)	Metal Closing Plate (For Ringless Sockets)
6003 - Gray Plastic	CP-21
6116 - Clear Plastic	
6002 - Clear Plastic	

Disconnect Sleeve



M5-144

Do not use with lever bypass sockets

Isolated Neutral Kit



K1047

ANSI-61-Gray



A-GP

12 oz. spray can of gray paint

Pole Hanger Kit

850 comes with 4 pole hangers





Catalog Number	Description of pole hanger brackets
850	Two pair (4 pieces) with mounting hardware

Please consult serving utility for their requirements prior to ordering or installing, as specifications and approvals vary by utility, and may require local electrical inspector approval. All installations must be installed by a licensed electrician and must comply with all national and local codes, laws and regulations. Milbank reserves the right to make changes in specifications and features shown without notice or obligation.



Fifth Terminals, Tap Connectors & Block Assemblies

Fifth Terminals

			
5T8K2 - 100-200 Amps "Plug-In"	K5T - 200 Amps (Block with Square Hole)	K3865 - Heavy Duty Jaw Clamping (K3866 without Neutral Wire)	K3356

Tap Connectors (3 per set)

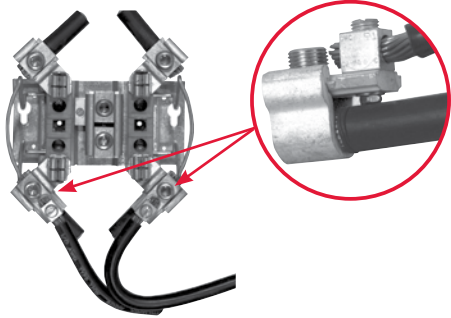
	Replaces the load or line side slide-in nut assembly on Milbank 200 Amps sockets. Allows for a 100 Amps tap location in addition to the #6-350 kcmil load-side connector. K5022 includes safety barrier extensions for applications over 300 VAC. Three lugs per kit.
K4977-INT - Internal Hex	
K4977-EXT - External Hex	
K5022-INT - Internal Hex (set of 4 with barrier) Wire Range #12 - 1/0	

Triplex Ground

K1190 (For factory installed triplex ground, add suffix -TG to catalog number)

100 Amps Blocks *(single sockets only)*

BL7474 - Block Assembly
Z904486-AO - Slotted Nut Assembly
Z802965-AC - Neutral without Nut
Z901925-AC - Hex Nut Set Screw

200 Amps Blocks *(single sockets only)*



K4527 - Internal Hex Block Assembly (with meter support)
K4528 - External Hex Block Assembly (with meter support)
Z916265-AO - Internal Hex Slide Nut Assembly
Z916264-AO - External Hex Slide Nut Assembly
Z814898-AC - Neutral without Nut



Please consult serving utility for their requirements prior to ordering or installing, as specifications and approvals vary by utility, and may require local electrical inspector approval. All installations must be installed by a licensed electrician and must comply with all national and local codes, laws and regulations. Milbank reserves the right to make changes in specifications and features shown without notice or obligation.

Replacement Receptacle Plates

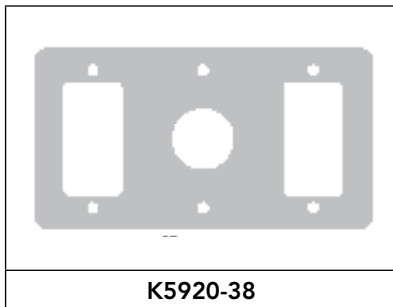
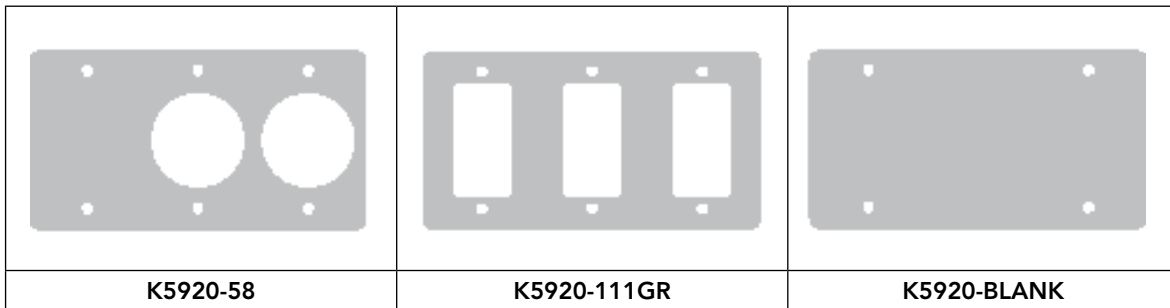
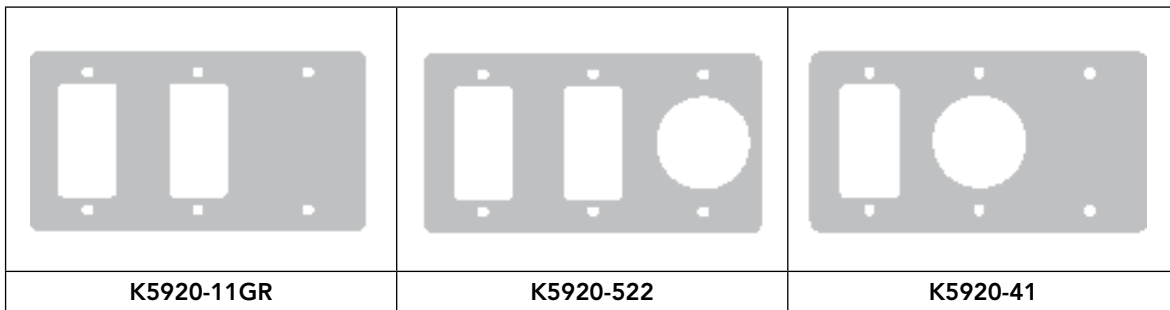
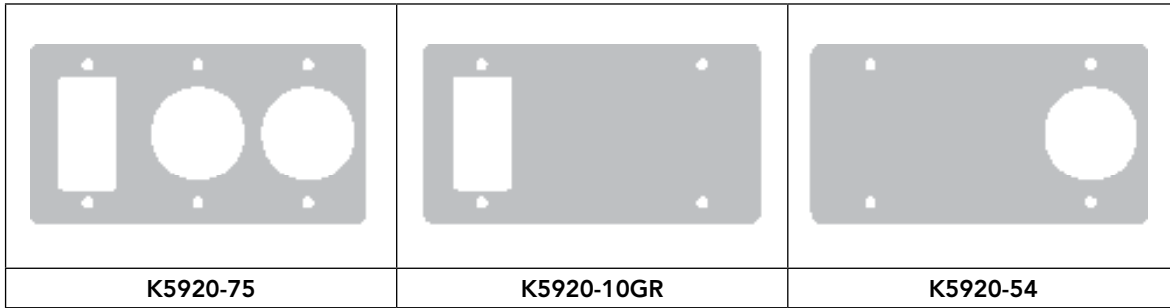
For Millennium Series RV Products



Notes

- For application details, consult factory.

Please consult serving utility for their requirements prior to ordering or installing, as specifications and approvals vary by utility, and may require local electrical inspector approval. All installations must be installed by a licensed electrician and must comply with all national and local codes, laws and regulations. Milbank reserves the right to make changes in specifications and features shown without notice or obligation.



Attractive | Easy to Install | Secure | Cost-Effective

Milbank Enclosed Controls are pad-mounted, weather resistant electrical enclosures consisting of a utility pull section with optional meter socket, and a customer section containing distribution and control equipment. Commercial pedestals are an attractive, secure, easy-to-install and cost-effective solution when underground remote site power distribution and control equipment is required, replacing unsightly and inefficient strut and backboard structures.



Strut and backboard



Commercial pedestal

UL Listed as Industrial Control Equipment (File E113855)

Standard Features

- NEMA Type 3R rain-resistant, vandal-resistant cabinet of polyurethane powder coated steel (aluminum or stainless steel also available)
- UL listed as enclosed industrial control equipment (UL508A)
- Isolated lockable and sealable utility metering and lug landing sections
- Lockable customer section for distribution and control equipment with internal deadfront
- Print pocket inside customer section door contains wiring schematics and installation instructions
- Load centers are UL listed for use with various manufacturers' circuit breakers
- All stainless steel external hardware (screws, bolts, hinges, handles, hasps and sealing screws)

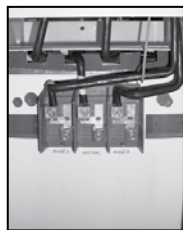

Please consult serving utility for their requirements prior to ordering or installing, as specifications and approvals vary by utility, and may require local electrical inspector approval. All installations must be installed by a licensed electrician and must comply with all national and local codes, laws and regulations. Milbank reserves the right to make changes in specifications and features shown without notice or obligation.

Enclosed Controls

47

Attractive | Easy to Install | Secure | Cost-Effective



Applications

These units are ideal for controlling and metering:

- Traffic signals
- Street lighting
- Power distribution for electronic vehicle charging stations
- Communication equipment such as cell towers and telephone vaults
- Event power for fairgrounds, swap meets, outdoor markets, portable offices, holiday lights, etc.
- Outdoor lighting for athletic fields, tennis and basketball courts, parking lots, landscaping and subdivision entrances, etc.

Available Factory-Installed Options

- Meter sockets: ring type or ringless, up to 400 Amps
- Main and branch breakers or T fuses
- Distribution: copper load centers and panelboards
- Clocks, timers and relays
- Photoelectric cells and controls
- Various power receptacles: pin and sleeve, twist lock or straight blade
- Contactors: lighting, definite purpose, motor starters
- Surge protection and lightning arresters
- Generator inlets with interlocked breakers
- Push button controls
- Thermostat controls, fans and heating strips
- Power blocks and terminal blocks
- Steel, aluminum and plywood backboards
- Transformers
- Interlock devices for circuit breakers

Options

- Available in steel, aluminum (raw painted or anodized) or stainless steel construction with powder coated finish available in eight standard colors or special-ordered RAL colors
- Available for applications up to 400 Amps, 120V, 208V, 240V, 277V, 480V - 1Ø or 3Ø

Please consult serving utility for their requirements prior to ordering or installing, as specifications and approvals vary by utility, and may require local electrical inspector approval. All installations must be installed by a licensed electrician and must comply with all national and local codes, laws and regulations. Milbank reserves the right to make changes in specifications and features shown without notice or obligation.

Accessories

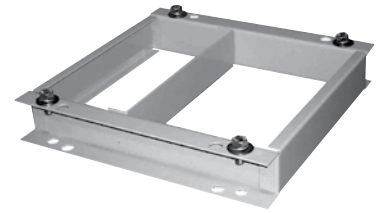

Pad-mount bases available for all pedestal sizes, inquire with your representative for details



CP-ABK5/8
Anchor bolt kit
(includes four 5/8 - 13
x 18" anchor bolts)



105J
Fifth terminal kit for
use with ring type
meter sockets



K3865
Fifth terminal kit for
use with ringless
meter sockets



CP-TC7D
7-day time clock kit
CP-TC24H
24-hour time clock kit
CP-TCWIRE
Male 4-pin connector
and wiring harness for
use with time clocks
other than above



CP-PE-HOA-3POS
HOA switch for field
installation



Main Load Center Commercial Pedestal

1Ø3 wire 120/240V or 208Y/120V

Application: Remote site service for multiple loads

Milbank Main Load Center Commercial Pedestals are designed to handle the vast majority of all requirements in a standard, stocked configuration.

- All units feature a load center with a plug-on, back-fed main breaker.
- Standard units are equipped with with a 16 circuit load center in the 100 Amps or 24 circuit load center in 200 Amps models.
- Sub-feed lug to allow feeding an external panel.

If your application requires turning loads on based on “dusk-to-dawn” requirements, be sure to see the Milbank Switched Load Center Commercial Pedestal products on the following page.

Features

These units include everything required for remote site service:

- Expandable: load centers allow for future expansion without costly modifications.
- All units feature a 200 Amps meter socket with optional field-installable fifth terminal kit available.
- 22K Amps interrupting capacity (AIC) standard.
- Optional mounting base can be embedded in concrete for fast, easy installation.
- Separate sealable and lockable utility termination section.
- Separate sealable and lockable metering section.
- Separate sealable and lockable customer section with a load center for “always on” loads that include a main circuit breaker, 20 (125 or 200 Amps model) or 14 (100 Amps model) blank breaker spaces and a circuit directory to document configuration.



Please consult serving utility for their requirements prior to ordering or installing, as specifications and approvals vary by utility, and may require local electrical inspector approval. All installations must be installed by a licensed electrician and must comply with all national and local codes, laws and regulations. Milbank reserves the right to make changes in specifications and features shown without notice or obligation.

Enclosed Controls

Switched Load Center Commercial Pedestals

Switched Load Center Commercial Pedestals

1Ø3 wire 120/240V or 208Y/120V

Designed not only to provide power for various loads, but also to switch specific loads on and off under certain conditions. A photoelectric cell is used for these controlled loads, and an optional time clock is also available.

Features

These units include everything required for remote site service:

- Expandable: load centers allow for future expansion without costly modifications.
- All units feature a 200 Amps meter socket with optional field-installable fifth terminal kit available.
- 22K Amps interrupting capacity (AIC) standard.
- Optional mounting base can be embedded in concrete for fast, easy installation.
- Separate sealable and lockable utility termination section.
- Separate sealable and lockable metering section.
- Separate sealable and lockable customer section with a control circuit including PE receptacle, Lexan® window, glare shield, Hand-Off-Auto (HOA) switch, contractor controlling a 16-circuit load center for controlled loads, a pre-mounted DIN rail and pre-wired connector to add an optional "plug-and-play" time clock kit for PE on and TC off operation and a circuit directory to document configuration.
- A load center for "always on" loads that includes a main circuit breaker, a control power circuit breaker, a switched load center main breaker, nine (125 or 200 Amps model) or 11 (100 Amps model) blank breaker spaces and a circuit directory to document configuration.



Ringless Lever Bypass shown



Traffic Signals

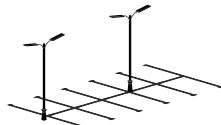

Parking Lots



Highways

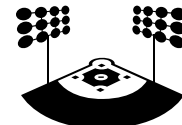

Athletic Field Lighting

Please consult serving utility for their requirements prior to ordering or installing, as specifications and approvals vary by utility, and may require local electrical inspector approval. All installations must be installed by a licensed electrician and must comply with all national and local codes, laws and regulations. Milbank reserves the right to make changes in specifications and features shown without notice or obligation.





Designed to provide a weather- and vandal-resistant metered enclosure for various loads and distribution. Each pedestal has been designed to handle a wide range of applications using standard, stocked configurations.

- Choice of a single main breaker or twin service disconnect breakers gives flexibility to the pedestal design.
- Optional distribution with feed-through lugs below the service disconnect breakers allows the pedestal to handle numerous applications.
- Typical applications include remote homes where the metering is best located at the curbside or other remote area. The pedestal can also provide power to a secondary residence, on-site business, workshop, irrigation, lighting, security or other secondary load.
- Refer to page 18 for color options.

Features

These units include everything required for remote service:

- Main circuit breaker or dual service disconnects
- Expandable: load center units allow for future expansion without costly modifications
- Optional mounting base can be embedded in concrete for fast, easy installation
- Separate sealable and lockable utility termination section with lug termination
- Separate sealable and lockable metering section
- Separate sealable and lockable customer section with a circuit directory and a print pocket to hold all documentation
- Meter socket options include ring type with bypass studs, ringless with heavy duty lever bypass, or K-type bolt-on



Commercial Job Sites



Remote Site for
Residential &
Commercial Job Sites



Please consult serving utility for their requirements prior to ordering or installing, as specifications and approvals vary by utility, and may require local electrical inspector approval. All installations must be installed by a licensed electrician and must comply with all national and local codes, laws and regulations. Milbank reserves the right to make changes in specifications and features shown without notice or obligation.

Surface-Mount Compact Design

Surface-Mount Enclosed Control

Originally developed for small cellular communications, the surface-mount enclosed control offers the flexibility of larger enclosed controls products with a smaller footprint and several mounting options.



Features

- Easy installation
- Overhead and underground entry and exit, all in one unit
- Meter and components in one enclosure
- UL508A & UL891
 - Custom component configurations
 - UL listing covers all internal components
- Can be mounted on multiple surfaces
 - Walls
 - Poles (narrow profile will have minimal extension past sides)
 - H Frames (Strut)
- Multiple bypass options available
- Monitoring options available
- Can be powder coated in any Milbank standard EC color or custom color.



Benefits

- Does not take up sidewalk space
- Flood resistant
- Eliminates need for connecting components
 - Wire in - Wire Out

Applications



Communications
Power
Distribution



Lighting
Control

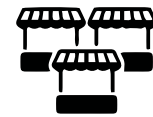

Streetscape
Power
Distribution

Please consult serving utility for their requirements prior to ordering or installing, as specifications and approvals vary by utility, and may require local electrical inspector approval. All installations must be installed by a licensed electrician and must comply with all national and local codes, laws and regulations. Milbank reserves the right to make changes in specifications and features shown without notice or obligation.



Battery Backup Commercial Pedestals

Designed to provide battery backup power for various loads and to switch specific loads on and off under certain conditions; a photoelectric cell or time clock to control lighting circuits, as an example. Metered and unmetered power distribution options are available. The backup power pedestal is designed to handle the vast majority of today's backup power requirements. By using a 19" rack design, shelves can be adjusted to accommodate the required batteries and manufacturers' DC to AC inverters, transfer switches and other related equipment. This design gives the user a wide range of design and configuration options. Complete turnkey, ready to power-up pedestals are offered along with basic units ready to accept batteries and inverters supplied by others.

Features

- Works with 100 through 320 Amps meter sockets with the option of either a ring type socket (conforms to EUSERC 308) with or without test/bypass blocks or a heavy duty ringless socket with lever bypass
- Separate sealable utility termination compartment
- An isolated separate customer section with service disconnects, power distribution options and power control
- 19" wide rack in customer compartment for easy layout of equipment
- Battery trays
- Thermostat with cooling fan
- Filtered louvers for heat rise flow through ventilation
- Three point door latch (key or pad-lockable)

Note

- May require customization based on regional requirements.



Traffic Signals



Communications
Power Distribution

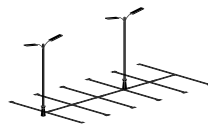

Parking Lots



Camera & Security
Locations

Options

- | | | |
|--|--|---|
| <ul style="list-style-type: none"> • Manual bypass switch • Transfer switch for generator power backup • Generator inlet receptacles 30 Amps through 200 Amps • Pad-lockable provision for receptacles | <ul style="list-style-type: none"> • Police access door • Metered load center distribution • Unmetered load center distribution • Photo electric controls (for street lighting) • Time clocks • HOA switches | <ul style="list-style-type: none"> • Contactors • GFCI duplex receptacles • Thermostat for heating control • Heating pads or elements • Roll out shelves for batteries • Surge arresters and lighting arresters |
|--|--|---|



Please consult serving utility for their requirements prior to ordering or installing, as specifications and approvals vary by utility, and may require local electrical inspector approval. All installations must be installed by a licensed electrician and must comply with all national and local codes, laws and regulations. Milbank reserves the right to make changes in specifications and features shown without notice or obligation.

Power Transfer Commercial Pedestals



Providing metered or unmetered AC power, distribution, surge suppression, mechanical interlock and standby generator receptacle — all in a neat, compact pedestal.

Features

- 120/240 VAC 1Ø3W through 277/480V 3Ø4W ratings
- Metered or unmetered units
- Choice of EUSERC ring type or ringless meter sockets
- 60 Amps through 400 Amps ratings
- Pad-lockable, isolated utility compartments
- 20 Amps GFCI convenience receptacle
- Lockable recessed generator receptacle door
- Utility and generator indicator light options
- All stainless steel hardware
- Galvanized steel, aluminum or stainless steel cabinet options
- Custom designs available

Note

- May require customization based on regional requirements.



Traffic Signals



Pump & Lift Stations



Communications
Power Distribution

Please consult serving utility for their requirements prior to ordering or installing, as specifications and approvals vary by utility, and may require local electrical inspector approval. All installations must be installed by a licensed electrician and must comply with all national and local codes, laws and regulations. Milbank reserves the right to make changes in specifications and features shown without notice or obligation.





Designed to be used where a smaller service package would be a better choice over larger switchgear equipment, these pedestals have amperage ratings of 400 to 800 Amps at voltages up through 480 VAC three phase.

Features

- Up to 800 Amps
- A low profile CT pedestal
- All utility equipment is isolated in separated pad lockable and sealable compartments
- Separate customer compartment designed to hold distribution and control equipment
- Dead front customer construction
- Optional mounting base
- Optional construction in steel, aluminum and stainless steel
- Refer to page 18 for color options

Note

- May require customization based on regional requirements

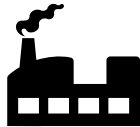

Commercial &
Industrial Control
Systems



Pump & Lift
Stations



Water Treatment
Plants



Electric Vehicle
Charging Stations



Please consult serving utility for their requirements prior to ordering or installing, as specifications and approvals vary by utility, and may require local electrical inspector approval. All installations must be installed by a licensed electrician and must comply with all national and local codes, laws and regulations. Milbank reserves the right to make changes in specifications and features shown without notice or obligation.

Slimline Commercial Pedestals



Provides a sleeker, smaller footprint, with wireway access on the side of the unit rather than the back, allowing maximum flexibility to place the pedestal anywhere physical space is at premium.

Providing unmetered AC power, distribution, surge suppression, mechanical interlock and standby generator receptacle — all in a neat, compact pedestal.

Features

- 100 or 200 Amps
- Vandal-resistant, secure and attractive design
- Customer compartment with distribution and control equipment with swing dead front door, secured with both a hasp/latch and draw latch outer door
- Utility metering compartment protected with a hinged hood, increasing resistance to meter vandalism
- Small footprint
- Wireway located on left side of pedestal for utility incoming wire, allowing pedestal to be mounted with back as close as 14" to walls or structures
- Available in 12" and 20" widths and 50" and 63" (metered) and 43" (unmetered) heights
- Includes a print pocket for plans and drawings
- Voltage range: 120V–480V
- Compatible with both ringless and ring type meter sockets, 4–7 terminals
- Available in a wide array of colors, including but not limited too all ANSI powder coated paint colors upon request
- Pedestal mounting base option saves time and labor to install on a cement pad—no anchor bolts required
- Powder coated G90 galvanized steel or Aluminum; raw, anodized or powder coated, as well as stainless steel exterior options

Note

- May require customization based on regional requirements.



Water Treatment
Plants



Highways



Parks &
Landscaping



Direct bury pedestals offer many advantages. With no need to coordinate, buy or wait for concrete, installation time can be cut down to less than an hour. Traditional direct bury pedestals are awkward to transport and handle and can only be used in a direct bury application. Milbank's modular design offers flexibility and convenience for distributors and contractors alike.



***Only available for 12" pedestals. Constructed with 14 gauge steel.**

Please consult serving utility for their requirements prior to ordering or installing, as specifications and approvals vary by utility, and may require local electrical inspector approval. All installations must be installed by a licensed electrician and must comply with all national and local codes, laws and regulations. Milbank reserves the right to make changes in specifications and features shown without notice or obligation.





NEMA Commercial Enclosures

Milbank's line of commercial enclosures includes the full gamut of styles and sizes: everything from junction boxes to transformer cabinets, telephone cabinets to wireways.

Type 1 Enclosures

Milbank's NEMA Type 1 enclosures are designed for indoor use to provide a degree of protection to personnel against access to hazardous parts and to provide a degree of protection of the equipment inside the enclosure against ingress of solid foreign objects, such as falling dirt.

NEMA Type 3R Enclosures

Milbank's NEMA Type 3R enclosures are designed for either indoor or outdoor use to provide a degree of protection from harmful effects on the equipment due to the ingress of water (rain, sleet, snow) or prevent damage from the external formation of ice on the enclosure.

Wireways

Milbank's wide range of wireways are available in many styles and sizes and a varied range of fittings allow smooth transitions to and from many manufacturers' products.



Please consult serving utility for their requirements prior to ordering or installing, as specifications and approvals vary by utility, and may require local electrical inspector approval. All installations must be installed by a licensed electrician and must comply with all national and local codes, laws and regulations. Milbank reserves the right to make changes in specifications and features shown without notice or obligation.

Watt-hour Meter Forms

Standard Forms | Transformer Rated or Self-Contained

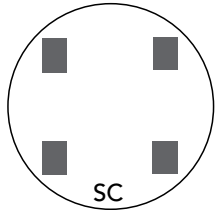

2 and 3-WIRE FORMS 1S & 2S

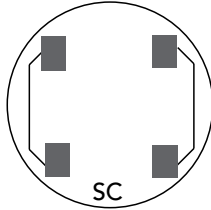

2 and 3-WIRE FORMS 1S & 2S with bypass

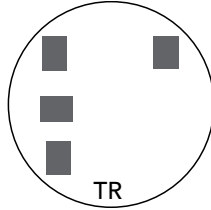

2-WIRE FORM 3S 5th Term. 9 o'clock

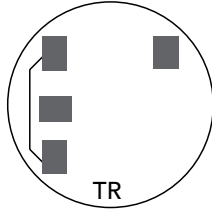

2-WIRE FORM 3S with bypass

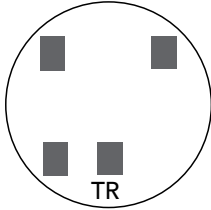

2-WIRE FORM 3S 5th Term. 6 o'clock

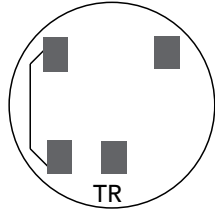

2-WIRE FORMS 3S with bypass

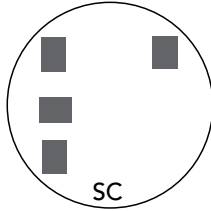

2 ELEMENT 3-WIRE NETWORK FORM 12S 5th Term. 9 o'clock

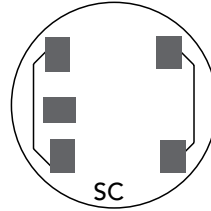

2 ELEMENT 3-WIRE NETWORK FORM 12S 5th Term. 9 o'clock

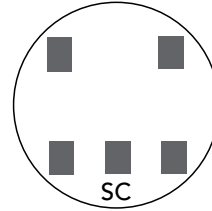

2 ELEMENT 3-WIRE NETWORK FORM 12S 5th Term. 6 o'clock

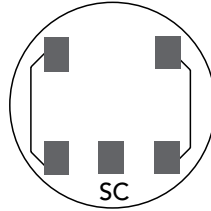

2 ELEMENT 3-WIRE NETWORK FORM 12S with bypass 5th Term. 6 o'clock

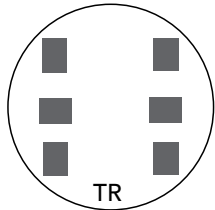

3-WIRE FORMS 4S

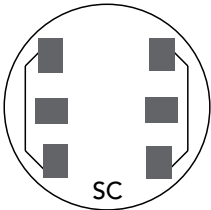

3-WIRE FORM 4S with bypass

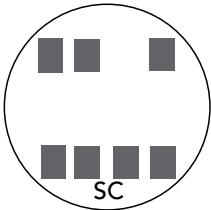

2 or 3 ELEMENT 3Ø4W Y or Δ Y FORM 14S

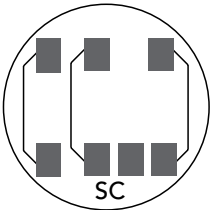

2 or 3 ELEMENT 3Ø4W Y or Δ with bypass

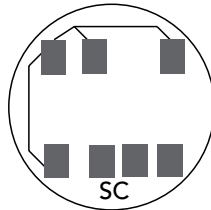

2 ELEMENT 3Ø4W Y or Δ Y FORM 7S Δ FORM 24S with bypass

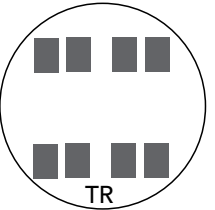

2 ELEMENT 2Ø3W, 2Ø4W, 3Ø3W FORM 5S

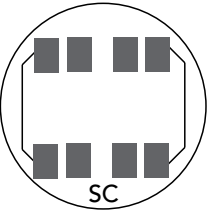

2 ELEMENT 2Ø3W, 2Ø4W, 3Ø3W FORM 5S with bypass

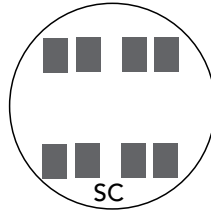

2 ELEMENT 2Ø3W, 2Ø4W, 3Ø3W FORM 13S

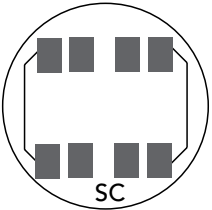

2 or 3 ELEMENT 2Ø3W, 2Ø4W, 3Ø3W FORM 13S with bypass

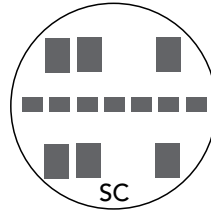

2 or 3 ELEMENT 3Ø4W Y or Δ Y FORM 9S Δ FORM 8S

TR= Transformer Rated
SC= Self-Contained

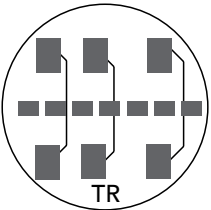

2 or 3 ELEMENT 3Ø3W, Y or Δ FORM 8S & 9S with bypass

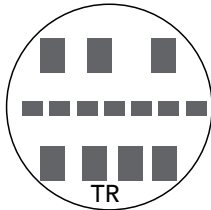

2 ELEMENT 3Ø4W Y FORM 6S

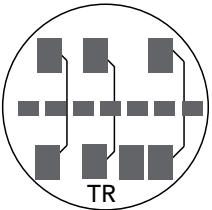

2 ELEMENT 3Ø4W Y FORM 6S with bypass

Please consult serving utility for their requirements prior to ordering or installing, as specifications and approvals vary by utility, and may require local electrical inspector approval. All installations must be installed by a licensed electrician and must comply with all national and local codes, laws and regulations. Milbank reserves the right to make changes in specifications and features shown without notice or obligation.



DIAGRAM A
1∅2W with 1 P.T. & 1 C.T.
Single Stator Meter(2W1∅) - Form 3S
5T Socket, Test Switch #TS04-0101

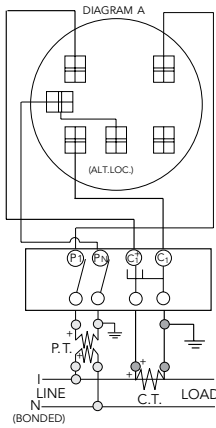

DIAGRAM B
1∅3W with 1 C.T.
Single Stator Meter(2W1∅) - Form 3S
5T Socket, Test Switch #TS04-0101

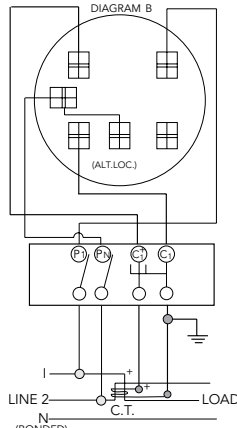

DIAGRAM C
1∅3W with 2 C.T.'s
Single Stator Meter(3W1∅) - Form 4S
6T Socket, Test Switch #TS07-0105

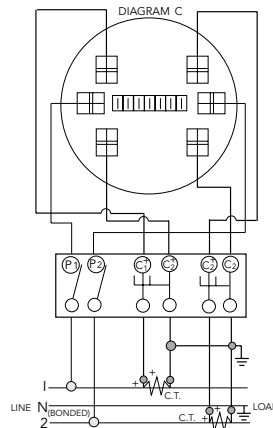

DIAGRAM D
1∅3W or 3W Network with 2 C.T.'s
2 Stator Meter - Form 5S
8T Socket, Test Switch #TS07-0105

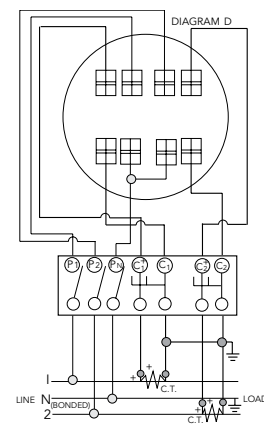

DIAGRAM E
3∅3W "Δ" with 2 P.T.'s & 2 C.T.'s
2 Stator Meter - Form 5S
8T Socket, Test Switch #TS07-0105

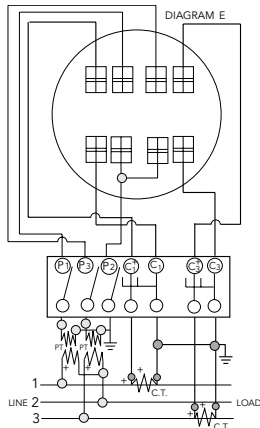

DIAGRAM F
3∅3W "Δ" with 2 C.T.'s
2 Stator Meter - Form 5S
8T Socket, Test Switch #TS07-0105

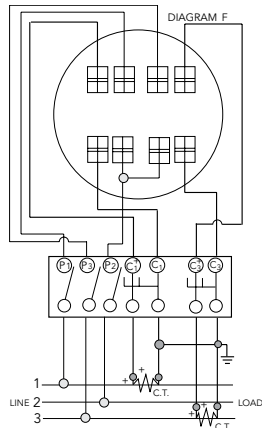

DIAGRAM G
3∅4W "Y" with 3 C.T.'s
2 1/2 Stator Meter - Form 6S
13T Socket, Test Switch #TS10-0109

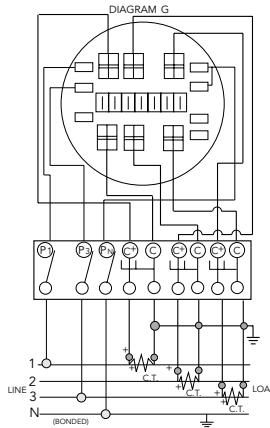

DIAGRAM H
3∅4W "Y" with 2 P.T.'s & 3 C.T.'s
2 1/2 Stator Meter - Form 6S
13T Socket, Test Switch #TS10-0109

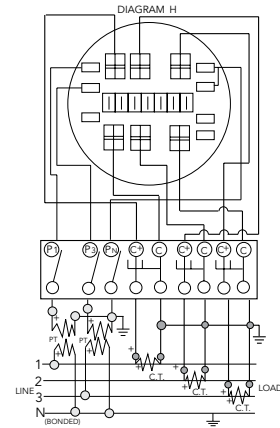

DIAGRAM I
3∅4W "Y" or "Δ" with 3 C.T.'s
"Y" 3 Stator Meter - Form 9S
"Δ" 2 Stator Meter - Form 8S
13T Socket, Test Switch #TS10-0109

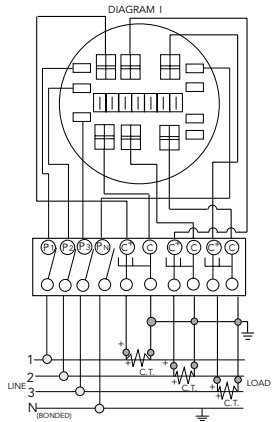
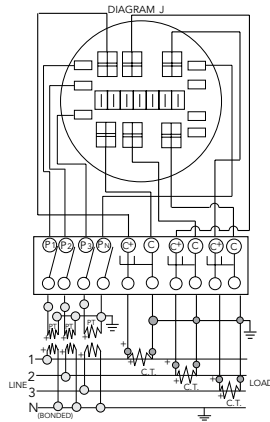

DIAGRAM J
3∅4W "Y" with 3 P.T.'s & 3 C.T.'s
3 Stator Meter - Form 9S
13T Socket, Test Switch #TS10-0109



Prewiring: If standard factory prewiring is required, refer to wiring diagrams on this page. Determine appropriate diagram and send a copy with order. If custom factory prewiring is required, specify on order. Be sure to include meter socket catalog number, test switch make and catalog number, meter form number and provide a copy of your wiring diagram.



Please consult serving utility for their requirements prior to ordering or installing, as specifications and approvals vary by utility, and may require local electrical inspector approval. All installations must be installed by a licensed electrician and must comply with all national and local codes, laws and regulations. Milbank reserves the right to make changes in specifications and features shown without notice or obligation.

Reference Information

MAXIMUM NUMBER OF CONDUCTORS IN CONDUIT

Table from 2008 NEC Code Reference: Rigid Metal Conduit

Type	Conductor Size (AWG/kcmil)	Conduit Trade Sizes (Inches)									
		½	¾	1	1¼	1½	2	2½	3	3½	4
THHN, THWN, THWN-2	12	9	16	26	46	62	102	146	225	301	387
	10	6	10	17	29	39	64	92	142	189	244
	8	3	6	9	16	22	37	53	82	109	140
	6	2	4	4	12	16	27	38	59	79	101
	4	1	2	4	7	10	16	23	36	48	62
	3	1	1	3	6	8	14	20	31	41	53
	2	1	1	3	5	7	11	19	26	34	44
	1	1	1	1	4	5	8	12	19	25	35
	1/0	1	1	1	3	4	7	10	16	21	27
	2/0	0	1	1	2	3	6	8	13	18	23
XHH, XHHW, XHHW-2	3/0	0	1	1	1	3	5	7	11	15	19
	4/0	0	1	1	1	2	4	6	9	12	16
	4	1	2	4	7	10	16	24	37	49	63
	2	1	1	3	5	7	12	17	26	35	45
	1/0	1	1	1	3	4	7	10	16	22	28
	2/0	0	1	1	2	3	6	9	13	18	23
	4/0	0	1	1	1	2	4	6	9	12	16
	250	0	0	1	1	1	3	5	7	10	13
	350	0	0	1	1	1	2	3	6	7	10
	500	0	0	0	1	1	1	2	4	5	7
750	0	0	0	0	1	1	1	3	4	5	

This table is for concentric stranded conductors only. For cables with compact conductors refer to NEC. Refer to latest NEC Code or Local Codes for updated requirements.

SAMPLE RATING LABEL

CATALOG NUMBERS U6962 & U6963
100A MAXIMUM, 120/240 VAC SINGLE PHASE, THREE WIRE
RAINFROOF NEMA TYPE 3R

SHORT CIRCUIT CURRENT RATING IS 10,000 RMS SYMMETRICAL AMPERE AT 240 VAC MAXIMUM, BUT IS LIMITED TO THE LOWEST SHORT CIRCUIT CURRENT RATING OF ANY INSTALLED CIRCUIT BREAKER. WATTHOUR METER NOT INCLUDED IN SHORT CIRCUIT CURRENT RATING. REPLACEMENT CIRCUIT BREAKER MUST BE THE SAME TYPE AND RATING. USE SIEMENS QP, QT, CUTLER-HAMMER CP, BD, BR; SQUARE D HOMELINE; G.E. TQ, THQ, THQL.

SUITABLE FOR USE AS RECREATIONAL VEHICLE SITE SUPPLY EQUIPMENT

UNDERGROUND FEED ONLY

ON TRIP OFF

TO RESET BREAKER MOVE TO "OFF" THEN TO "ON"

DANGER
HAZARD OF ELECTRICAL SHOCK OR BURN
TURN OFF POWER
SUPPLYING THIS EQUIPMENT BEFORE WORKING INSIDE

WIRE TERMINAL INFORMATION USE AL-CU CONDUCTORS		
TERMINAL	WIRE RANGE	TORQUE LB-IN
LINE AND LINE NEUTRAL	350 kcmil - # 6	250
GROUND CONNECTOR	20 AWG - #14 AWG	120
LOAD NEUTRAL SLOTTED HEAD (LARGE HOLE)	14 - 10	35
	8	40
	6 - 4	45
LOAD NEUTRAL SLOTTED HEAD (SMALL HOLE)	3 - 1/0	50
	14 - 10	20
	8	25
	6	35

SHIPPING TENDS TO LOOSEN BOLTED CONNECTIONS. CHECK AND TIGHTEN ALL HARDWARE BEFORE ENERGIZING UNIT.

SIZE OF FIELD INSTALLED CONDUCTORS SHALL BE 60° FOR 75° C SIZED TO 60° C RATING FOR 110 AMPS OR LESS AND 75° C SIZED TO 75° C FOR 125 AMPS AND ABOVE.

* ALLOWABLE AMPACITIES OF INSULATED COPPER & ** ALUMINUM CONDUCTORS (3W IN CONDUIT) 75° C (167° F)

A		AL or **CU-Clad AL	
A	B	A	B
18	—	—	—
16	—	—	—
14	20†	—	—
12	25†	12	20†
10	35†	10	30†
8	50	8	40
6	65	6	50
4	85	4	65
3	100	3	75
2	115	2	90
1	130	1	100
1/0	150	1/0	120
2/0	175	2/0	135
3/0	200	3/0	155
4/0	230	4/0	180
250	255	250	205
300	285	300	230
350	310	350	250
400	335	400	270
500	380	500	310
600	420	600	340
700	460	700	375
750	475	750	385

A = Size: AWG/MCM
***B** = Ampere Rating for Insulation Types:
FEPW, RH, RHW, THW, THWN, XHHW, USE, 2W.
****C** = Ampere Rating for Insulation Types:
RH, RHW, THW, THWN, XHHW, USE
(Per NEC table 310-16)

AMPACITY CORRECTION FACTORS

Ambient Temp. C°	Correction Factor	Ambient Temp. F°
21 - 25	1.05	70 - 77
25 - 30	1.00	78 - 86
31 - 35	.94	87 - 95
36 - 40	.88	96 - 104
41 - 45	.82	105 - 113
46 - 50	.75	114 - 122
51 - 55	.67	123 - 131
56 - 60	.58	132 - 140
61 - 65	.33	141 - 158

Overall Ampere ratings of UL listed Milbank multiple position meter sockets are based on 2008 NEC Handbook Article 220-84 and ANSI / UL-414 (except where restricted by line connector size.) These requirements provide for a diversity factor / demand factor being utilized in determining the overall (main bus / lug) rating of a gang socket. All Milbank UL listed gang sockets meet or exceed these diversity factor/demand and factor requirements. Standard overall ampacity ratings for UL listed and non UL listed gang sockets are as shown in the chart below. Ampere ratings of meter sockets are based on the meter socket being wired with 75° C insulated wire conductor, sized in accordance with Table 310-16 of the National Electric Code.

GANG SOCKET OVERALL AMPACITIES

# of Meter Pos.	100A/Pos. Ampacity	125A/Pos. Ampacity	150A/Pos. Ampacity	200A/Pos. Ampacity
2	200A	200A	200A	200A #
3	200A	225A	225A	270A
4	200A	250A	270A	360A
5	225A	285A	338A	450A
6	270A	330A	396A	528A

† Unless otherwise permitted elsewhere in the Code, the overcurrent protection for conductor types marked with an obelisk (†) shall not exceed 15 Amps for 14 AWG, 20 Amps for 12 AWG, and 30 Amps for 10 AWG copper; or 15 Amps for 12 AWG and 25 Amps for 10 AWG aluminum and copper-clad aluminum after any correction factors for ambient temperature and number of conductors have been applied.
 # Some constructions are rated at 400 Amps overall (1252). Contact your sales representative for more information. Refer to latest NEC Code or Local Codes for updated requirements.

Please consult serving utility for their requirements prior to ordering or installing, as specifications and approvals vary by utility, and may require local electrical inspector approval. All installations must be installed by a licensed electrician and must comply with all national and local codes, laws and regulations. Milbank reserves the right to make changes in specifications and features shown without notice or obligation.



Important Note

In addition to national and local electrical codes, many utilities have specific requirements for metering equipment. Always consult the serving utility for their specifications and requirements prior to ordering or installing Milbank meter mounting equipment.

Before Energizing

1. Give equipment a thorough visual examination to determine that:
 - a) No shipping or installation damage exists.
 - b) Proper clearances have been maintained.
 - c) All connections have been made.
 - d) Equipment is clean and dry.
2. Make a thorough examination to:
 - a) Verify tightness of all bolted connections (see table below).
 - b) Manually operate all circuit breakers, switches, relays, etc.
 - c) Check rigidity of all mountings, bus bars and components.
 - d) Use test equipment to check continuity of circuitry and integrity of insulation.
3. All switches and circuit breakers should be in the OFF position.
4. Verify that manual meter bypass (if applicable) is in non-bypass position.
5. Install cover and/or close doors.
6. If installation is not being energized at this time, follow "after-energizing" steps listed below. These steps will secure the installation in case of accidental energization.

When Energizing

1. Use caution and follow established safety procedures:
 - a) Wear safety apparel.
 - b) Use safety equipment.
 - c) Take action to prevent injury to yourself and others in the event of failure of the installation.
 - d) Take action to prevent/decrease damage to property in the event of failure of the installation.
 - e) If you are unsure how to safely energize the installation, get someone who is knowledgeable to do it.

After Energizing

1. Secure the installation:
 - a) To prevent accidental contact with energized parts, cover all openings with approved filler devices.
 - b) To prevent unauthorized access, secure all covers and/or doors with approved security devices.
 - c) Attach/post information to advise others of potential hazards associated with the installation.

Recommended Torque for General Applications*

Nominal Size	Joint Description		Head Type	Torque (Inch Lbs.)
	Screw	Nut		
10	Brass	Brass Nut or Extruded Hole	All	20-25 inch lbs.
10	Steel	Copper or Aluminum Busbar ≤ 1/8"	All	25-30 inch lbs.
10	Steel	Steel Nut or Extruded Hole; CU or AL Busbar > 1/8"	All	30-35 inch lbs.
12	Steel	Aluminum Extruded Hole	All	30-35 inch lbs.
12	Steel	Steel Nut or Extruded Hole	All	40-50 inch lbs.
1/4	Steel	Aluminum Extruded Hole	All	40-50 inch lbs.
1/4	Steel	Steel Nut or Extruded Hole; CU or AL Busbar	All	50-60 inch lbs.
5/16	Steel	Aluminum Extruded Hole	Hex	60-70 inch lbs.
5/16	Steel	Steel Nut or Extruded Hole; CU or AL Busbar	Hex	100-150 inch lbs.
3/8	Steel	Steel Nut	Hex	150-200 inch lbs.
1/2	Steel	Steel Nut	Hex	200-250 inch lbs.

* Interior labels typically indicate the required torque for wire connectors and studs, and should be referenced first.
CU: Copper
AL: Aluminum



Please consult serving utility for their requirements prior to ordering or installing, as specifications and approvals vary by utility, and may require local electrical inspector approval. All installations must be installed by a licensed electrician and must comply with all national and local codes, laws and regulations. Milbank reserves the right to make changes in specifications and features shown without notice or obligation.

Reference Information

Materials

Steel Quality

The meter equipment listed in this catalog is made of galvanized steel (AISI* G90) to afford the best possible weather proofing.
*American Iron and Steel Institute.

Steel Sheet

16 gauge, galvanized, sheet: 1 1/4 oz./ sq.ft. class zinc-coated. (AISI G90)
14 gauge, galvanized, sheet: 1 1/4 oz./ sq.ft. class zinc-coated.

Aluminum Extrusion

Wire-Terminals: Alloy; 6061-T6, Tin-plated for CU/AL wire.
Bus Bar: Alloy; 6101-o & 6063-O

Aluminum Sheet

3000 series aluminum sheet, H14, or 5052 series aluminum sheet, H32. Where applicable thicknesses range from .064 – .125

Copper Sheet & Bus

Electrolytic copper with tin plating in most applications.

Insulating Materials

- In most units, support bases for current-carrying components are molded from fiberglass reinforced high-strength, track resistant, thermoset polyester molding compounds.
- Clear or black safety shields and polarity barriers are molded from high-strength, track resistant, polycarbonate molding compounds.
- Various sheet insulating materials, as appropriate for the application are utilized in the fabrication of flat, formed and punched component parts and barriers.

Finish

Process

Light gray state-of-the-art electrostatically applied powder paint offers a durable, non-fading finish. For further information concerning the chemical analysis of the weather-resistant finish, please contact the factory.

Metal Fasteners

Zinc-coated with a chromate dip.

Ratings & Compliance

Ratings & Compliance

All Milbank electrical enclosures in this catalog are rated NEMA Type 3R Enclosure unless otherwise specified on the product's page. All enclosures with a UL designation are constructed per the appropriate UL Standard and may be installed per the National Electric Code. UL procedure files associated with the UL Standards are listed as follows: Meter Sockets (UL 414, File E30202), Test Switches (UL 414, File E62531), Power Outlets (UL 231, File E90945), Panelboards (UL 67, File E32628) and Pullout Switches (UL 1429, File E133062). Additional standards are utilized as applicable: Meter Sockets (ANSI C12.7), Test Switches (ANSI C12.9) and Panelboards (NEMA PB-1).

Please consult serving utility for their requirements prior to ordering or installing, as specifications and approvals vary by utility, and may require local electrical inspector approval. All installations must be installed by a licensed electrician and must comply with all national and local codes, laws and regulations. Milbank reserves the right to make changes in specifications and features shown without notice or obligation.



Catalog Number	AEP	First Energy	DP&L
U7487-RL-TG-KK		X	X
U7487-RL-TG-KK-BLG	X		
U7021-RL-TG-KK		X	X
U7021-RL-TG-KK-BLG	x		
U7040-RL-TG-KK		X	
U7040-RL-TG-KK-BLG	X		
U7040-XL-TG-KK		X	
U1980-O-KK		X	X
U1980-O-KK-BLG	X		
U9551-RRL		X	X
U9701-RRL		X	
U9701-RRL-BLG	X		
U1079-RRL-K3		X	X
U4905-X		X	
U4905-X-BLG	X		
U1129-O-K3L-K2L		X	X
U5161-X-K3L-K2L-BLG	X		
U1797-O-K3L-K2L		X	
U1797-O-K3L-K2L-BLG	X		
U2594-X		X	
U2594-X-K7-K6-BLG	X		
U2594-X-BLG	X		
U3989-XL		X	
U5844-PXL-200-KK		X	X
U5844-PXL-200-KK-BLG	X		
USE-22-200-MB		X	
U5168-XTL-100-KK		X	
U5168-XTL-100-KK-BLG	X		
U5168-XTL-150-KK		X	
U5168-XTL-150-KK-BLG	X		
U5168-XTL-200-KK		X	X
U5168-XTL-200-KK-BLG	X		
U5268-XTL-150-KK		X	
U5268-XTL-200-KK		X	
U5268-XTL-200-KK-BLG	X		
U5871-XL-200		X	
U5890-X-2/200-BL	X	X	
U5890-X-2/200-BLG	X	X	
U5891-X-2/200-MLK-BL	X	X	
U1232-RRL-KK-K1		X	
U1233-RRL-KK-K1		X	
U1234-RXL-KK-K1		X	
U1252-RRL-KK-K1-SLVG		X	
U1252-RRL-KK-K1-BLG-SLVG	X		

Catalog Number	AEP	First Energy	DP&L
U1253-RRL-KK-K1-SLVG		X	
U1253-RRL-KK-K1-BLG-SLVG	X		
U1254-RXL-KK-K1-SLVG		X	
U1254-RXL-KK-K1-BLG-SLVG	X		
U1255-RXL-KK-K1-SLVG		X	
U1255-RXL-KK-K1-BLG-SLVG	X		
U1256-RXL-KK-K1-SLVG		X	
U1256-RXL-KK-K1-BLG-SLVG	X		
U2872-XT		X	
U2873-XT		X	
U2874-XT		X	
U2875-XT		X	
U2876-XT		X	
U2732-XT		X	
U2733-XT		X	
U2734-XT		X	
U2735-XT		X	
U2736-XT		X	
U2852-X	X	X	
U2853-X	X	X	
U2854-X	X	X	
U2855-X	X	X	
U2856-X	X	X	
U2862-X	X	X	
U2863-X	X	X	
U2864-X	X	X	
U2865-X	X	X	
U2866-X	X	X	
U5902-X-KK-BLG	X	X	
U5903-X-KK-BLG	X	X	
U5904-X-KK-BLG	X	X	
U5905-X-KK-BLG	X	X	
U5906-X-KK-BLG	X	X	
U5882-X-KK-BLG	X	X	
U5883-X-KK-BLG	X	X	
U5884-X-KK-BLG	X	X	
U5885-X-KK-BLG	X	X	
U5886-X-KK-BLG	X	X	
243210-CTC3R			X
363612-LC3R-SP-WB	X	X	
484812-CT3R-WB	X	X	
U5990-O	X	X	



Please consult serving utility for their requirements prior to ordering or installing, as specifications and approvals vary by utility, and may require local electrical inspector approval. All installations must be installed by a licensed electrician and must comply with all national and local codes, laws and regulations. Milbank reserves the right to make changes in specifications and features shown without notice or obligation.

850.....	43	K5920-75.....	45	QN2150R.....	41
6002.....	43	K5920-BLANK.....	45	QN2150RH.....	41
6003.....	43	K5T.....	44	QN2200.....	41
6116.....	43	M5-144.....	43	QN2200H.....	41
243210-CTC3R.....	35	Q115.....	41	QN2200R.....	41
304410-CTC3R.....	35	Q115H.....	41	QN2200RH.....	41
363612-LC3R-SP-WB.....	35	Q120.....	41	-R.....	42
484812-CT3R-WB.....	35	Q120H.....	41	-RL.....	42
5T8K2.....	44	Q125.....	41	S4019-O.....	35
A-GP.....	43	Q125H.....	41	S4020-O.....	35
A7514.....	42	Q130.....	41	S4399-O.....	35
A7515.....	42	Q130H.....	41	S4400-O.....	35
A7516.....	42	Q135.....	41	S8324.....	42
A7517.....	42	Q135H.....	41	S8324.....	42
A7518.....	42	Q140.....	41	TS04-0101.....	33
A7551.....	42	Q140H.....	41	TS04-0102.....	33
A7551.....	42	Q150.....	41	TS04-0103.....	33
A8110.....	42	Q150H.....	41	TS04-0104.....	33
A8111.....	42	Q160.....	41	TS07-0018.....	33
A8112.....	42	Q160H.....	41	TS07-0022.....	33
A9064.....	42	Q170.....	41	TS07-0049.....	33
BL7474.....	44	Q170H.....	41	TS07-0059.....	33
CP-21.....	43	Q2100.....	41	TS07-0105.....	33
K1047.....	43	Q2100H.....	41	TS07-0106.....	33
K1190.....	44	Q2125.....	41	TS07-0107.....	33
K1350.....	43	Q2125H.....	41	TS07-0108.....	33
K1350L.....	43	Q215.....	41	TS10-0109.....	33
K1539.....	43	Q215H.....	41	TS10-0110.....	33
K1540.....	43	Q220.....	41	TS10-0111.....	33
K1540L.....	43	Q220H.....	41	TS10-0112.....	33
K1541.....	43	Q225.....	41	U1079-RRL-K3.....	11
K3082.....	43	Q225H.....	41	U1129-O-K3L-K2L.....	11
K3083.....	43	Q230.....	41	U1232-RRL-KK-K1.....	20
K3356.....	44	Q230H.....	41	U1233-RRL-KK-K1.....	20
K3441.....	43	Q235.....	41	U1234-RXL-KK-K1.....	20
K3442.....	43	Q235H.....	41	U1252-RRL-KK-K1-BLG-SLVG.....	21
K3865.....	44	Q240.....	41	U1252-RRL-KK-K1-SLVG.....	21
K4527.....	44	Q240H.....	41	U1253-RRL-KK-K1-BLG-SLVG.....	21
K4528.....	44	Q250.....	41	U1253-RRL-KK-K1-SLVG.....	21
K4977-EXT.....	44	Q250H.....	41	U1254-RXL-KK-K1-BLG-SLVG.....	21
K4977-INT.....	44	Q260.....	41	U1254-RXL-KK-K1-SLVG.....	21
K5022-INT.....	44	Q260H.....	41	U1255-RXL-KK-K1-BLG-SLVG.....	21
K5920-10GR.....	45	Q270.....	41	U1255-RXL-KK-K1-SLVG.....	21
K5920-111GR.....	45	Q270H.....	41	U1256-RXL-KK-K1-BLG-SLVG.....	21
K5920-11GR.....	45	Q280.....	41	U1256-RXL-KK-K1-SLVG.....	21
K5920-38.....	45	Q280H.....	41	U1797-O-K3L-K2L.....	11
K5920-41.....	45	Q290.....	41	U1797-O-K3L-K2L-BLG.....	11
K5920-522.....	45	Q290H.....	41	U1980-O-KK.....	9
K5920-54.....	45	QN2150.....	41	U1980-O-KK-BLG.....	9
K5920-58.....	45	QN2150H.....	41	U2120-X-K7.....	12

Please consult serving utility for their requirements prior to ordering or installing, as specifications and approvals vary by utility, and may require local electrical inspector approval. All installations must be installed by a licensed electrician and must comply with all national and local codes, laws and regulations. Milbank reserves the right to make changes in specifications and features shown without notice or obligation.



U2594-X.....	12	U4908-O-11GR.....	37	U5890-X-2/200-BL.....	17
U2594-X-BLG.....	12	U5000-XL.....	38	U5890-X-2/200-BLG.....	17
U2594-X-K7-K6-BLG.....	12	U5000-XL-41.....	38	U5891-X-2/200-MLK-BL.....	17
U2732-XT.....	24	U5000-XL-55.....	38	U5902-X-KK-BLG.....	28
U2733-XT.....	24	U5000-XL-75.....	38	U5903-X-KK-BLG.....	28
U2734-XT.....	24	U5059-X-2/200-K3L.....	17	U5904-X-KK-BLG.....	28
U2735-XT.....	24	U5059-X-K3L.....	17	U5905-X-KK-BLG.....	28
U2736-XT.....	24	U5100-XL.....	38	U5906-X-KK-BLG.....	28
U2852-X.....	26	U5100-XL-41.....	38	U5971-XL-100.....	13
U2853-X.....	26	U5100-XL-55.....	38	U5971-XL-150.....	13
U2854-X.....	26	U5100-XL-75.....	38	U5971-XL-200.....	13
U2855-X.....	26	U5101-XL-11GR.....	37	U5990-O.....	35
U2856-X.....	26	U5136-O.....	36	U6115-X-2/200-K7L.....	17
U2862-X.....	26	U5136-O-100S.....	36	U6220-O-100-KK-10GR.....	36
U2863-X.....	26	U5136-O-200S.....	36	U6220-O-200-KK-10GR.....	36
U2864-X.....	26	U5137-O-200S.....	36	U6227-x-400-k3.....	18
U2865-X.....	26	U5161-X-K3L-K2L-BLG.....	11	U6228-x-400-K3.....	18
U2866-X.....	26	U5168-XTL-100-KK.....	16	U6229-X-400-K7.....	18
U2872-XT.....	23	U5168-XTL-100-KK-BLG.....	16	U6230-X-400-K7.....	18
U2873-XT.....	23	U5168-XTL-150-KK.....	16	U7021-RL-TG-KK.....	9
U2874-XT.....	23	U5168-XTL-150-KK-BLG.....	16	U7021-RL-TG-KK-BLG.....	9
U2875-XT.....	23	U5168-XTL-200-KK.....	16	U7040-RL-TG-KK.....	9
U2876-XT.....	23	U5168-XTL-200-KK-BLG.....	16	U7040-RL-TG-KK-BLG.....	9
U3278-RL.....	10	U5200-XL.....	39	U7040-XL-TG-KK.....	9
U3802.....	6	U5200-XL-41.....	39	U7487-RL-TG-KK.....	9
U3812.....	6	U5200-XL-55.....	39	U7487-RL-TG-KK-BLG.....	9
U3822-20GWR.....	7	U5200-XL-75.....	39	U9551-RRL.....	10
U3832.....	6	U5268-XTL-150-KK.....	16	U9701-RRL.....	10
U3862.....	6	U5268-XTL-200-KK.....	16	U9701-RRL-BLG.....	10
U3989-XL.....	14	U5268-XTL-200-KK-BLG.....	16	UC1299-RL.....	30
U4363-X-QG-K3-K2.....	11	U5300-O.....	39	UC1300-RL.....	30
U4372-XT-5T9.....	25	U5300-O-41.....	39	UC7235-RL.....	30
U4372-XT-5T9.....	25	U5300-O-55.....	39	UC7237-XL.....	30
U4373-XT-5T9.....	25	U5300-O-75.....	39	UC7444-RL.....	31
U4373-XT-5T9.....	25	U5750-RXL-200-BL.....	15	UC7445-RL.....	31
U4374-XT-5T9.....	25	U5764-X-200-CB.....	19	UC7445-RL-641.....	31
U4374-XT-5T9.....	25	U5765-X-200-CB.....	19	UC7445-WL.....	31
U4375-XT-5T9.....	25	U5767-X-200-CB.....	19	UC7448-RL.....	31
U4375-XT-5T9.....	25	U5784-O-200-CB.....	19	UC7449-RL.....	31
U4376-XT-5T9.....	25	U5787-O-200-CB.....	19	UC7460-RL.....	31
U4376-XT-5T9.....	25	U5796-X-400-CB.....	19	UC7461-RL.....	31
U4408-O.....	35	U5797-O-400-CB.....	19	UC7478-RL.....	31
U4410-O.....	35	U5799-O-400-CB.....	19	UC7532-RL.....	31
U4490-XL.....	32	U5844-PXL-200-KK.....	14	UC7636-RL.....	31
U4492-XL.....	32	U5844-PXL-200-KK-BLG.....	14	UQFB-100.....	40
U4493-XL.....	32	U5871-XL-200.....	15	UQFB-100-X1.....	40
U4532-XL.....	9	U5882-X-KK-BLG.....	28	UQFB-125.....	40
U4881-O-50GB.....	8	U5883-X-KK-BLG.....	28	UQFB-125-X1.....	40
U4881-O-60GB.....	8	U5884-X-KK-BLG.....	28	UQFB-150.....	40
U4905-X.....	11	U5885-X-KK-BLG.....	28	UQFB-150-X1.....	40
U4905-X-BLG.....	11	U5886-X-KK-BLG.....	28	UQFB-175.....	40



Please consult serving utility for their requirements prior to ordering or installing, as specifications and approvals vary by utility, and may require local electrical inspector approval. All installations must be installed by a licensed electrician and must comply with all national and local codes, laws and regulations. Milbank reserves the right to make changes in specifications and features shown without notice or obligation.

UQFB-175-X1	40
UQFB-200.....	40
UQFB-200-X1	40
UQFBH-100	40
UQFBH-125	40
UQFBH-150	40
UQFBH-175	40
UQFBH-200	40
UQFBH-M-100.....	40
UQFBH-M-125.....	40
UQFBH-M-150.....	40
UQFBH-M-175.....	40
UQFBH-M-200.....	40
UQFP-100.....	40
UQFP-125.....	40
UQFP-150	40
UQFP-175	40
UQFP-200.....	40
UQFPH-100	40
UQFPH-125	40
UQFPH-150	40
UQFPH-175	40
UQFPH-200	40
UQFPH-M-100.....	40
UQFPH-M-125	40
UQFPH-M-150.....	40
UQFPH-M-175	40
UQFPH-M-200.....	40
UQFP-M-100	40
UQFP-M-125	40
UQFP-M-150	40
UQFP-M-175	40
UQFP-M-200	40
USE-22-200-MB.....	13
WBJ2150	41
WBJ2200	41
Z802965-AC	44
Z814898-AC	44
Z901925-AC	44
Z904486-AO.....	44
Z916264-AO.....	44
Z916265-AO	44
.....	

Please consult serving utility for their requirements prior to ordering or installing, as specifications and approvals vary by utility, and may require local electrical inspector approval. All installations must be installed by a licensed electrician and must comply with all national and local codes, laws and regulations. Milbank reserves the right to make changes in specifications and features shown without notice or obligation.



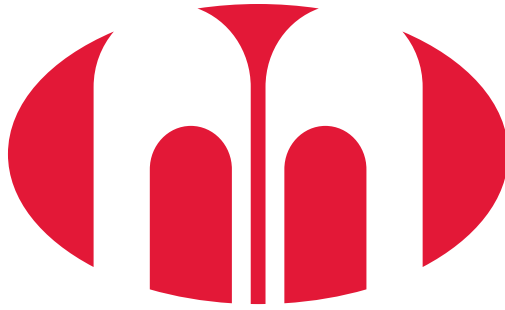

MILBANK[®]

ENERGY AT WORK

